

STATE OF NORTH CAROLINA
DEPARTMENT OF TRANSPORTATION
HIGHWAY DIVISION 3

PROPOSAL

DATE AND TIME OF BID OPENING: JANUARY 16, 2020 AT 2:00 PM

CONTRACT ID: DC00277

WBS ELEMENT NO.: 50115.3.2

FEDERAL AID NO.: 0074228

COUNTY: NEW HANOVER COUNTY

TIP NO.: U-5710A

MILES: 0.251 MILES

ROUTE NO.: US 17, US 74 & DRYSDALE DRIVE EXT.

**LOCATION: FROM US-17 (MILITARY CUTOFF RD.) AT DRYSDALE DR. TO
US-74 (EASTWOOD RD.) CONSTRUCT ROADWAY AT NEW
LOCATION (DRYSDALE DRIVE EXT.)**

TYPE OF WORK: GRADING, PAVING, DRAINAGE AND SIGNALS

NOTICE:

ALL BIDDERS SHALL COMPLY WITH ALL APPLICABLE LAWS REGULATING THE PRACTICE OF GENERAL CONTRACTING AS CONTAINED IN CHAPTER 87 OF THE GENERAL STATUTES OF NORTH CAROLINA WHICH REQUIRES THE BIDDER TO BE LICENSED BY THE N.C. LICENSING BOARD FOR CONTRACTORS WHEN BIDDING ON ANY NON-FEDERAL AID PROJECT WHERE THE BID IS \$30,000 OR MORE, EXCEPT FOR CERTAIN SPECIALTY WORK AS DETERMINED BY THE LICENSING BOARD. BIDDERS SHALL ALSO COMPLY WITH ALL OTHER APPLICABLE LAWS REGULATING THE PRACTICES OF ELECTRICAL, PLUMBING, HEATING AND AIR CONDITIONING AND REFRIGERATION CONTRACTING AS CONTAINED IN CHAPTER 87 OF THE GENERAL STATUTES OF NORTH CAROLINA. NOTWITHSTANDING THESE LIMITATIONS ON BIDDING, THE BIDDER WHO IS AWARDED ANY FEDERAL - AID FUNDED PROJECT SHALL COMPLY WITH CHAPTER 87 OF THE GENERAL STATUTES OF NORTH CAROLINA FOR LICENSING REQUIREMENTS WITHIN 60 CALENDAR DAYS OF BID OPENING.

THIS IS A ROADWAY PROJECT.

BID BONDS ARE REQUIRED.

NAME OF BIDDER

ADDRESS OF BIDDER

**PROPOSAL FOR THE CONSTRUCTION OF
CONTRACT No. DC00277 IN NEW HANOVER COUNTY, NORTH CAROLINA**

Date _____ 20____

**DEPARTMENT OF TRANSPORTATION,
RALEIGH, NORTH CAROLINA**

The Bidder has carefully examined the location of the proposed work to be known as Contract No. **DC00277**; has carefully examined the plans and specifications, which are acknowledged to be part of the proposal, the special provisions, the proposal, the form of contract, and the forms of contract payment bond and contract performance bond; and thoroughly understands the stipulations, requirements and provisions. The undersigned bidder agrees to bound upon his execution of the bid and subsequent award to him by the Department of Transportation in accordance with this proposal to provide the necessary contract payment bond and contract performance bond within fourteen days after the written notice of award is received by him. The undersigned Bidder further agrees to provide all necessary machinery, tools, labor, and other means of construction; and to do all the work and to furnish all materials, except as otherwise noted, necessary to perform and complete the said contract in accordance with *the 2018 Standard Specifications for Roads and Structures* by the dates(s) specified in the Project Special Provisions and in accordance with the requirements of the Engineer, and at the unit or lump sum prices, as the case may be, for the various items given on the sheets contained herein.

The Bidder shall provide and furnish all the materials, machinery, implements, appliances and tools, and perform the work and required labor to construct and complete State Highway Contract No. **DC00277** in **NEW HANOVER COUNTY**, for the unit or lump sum prices, as the case may be, bid by the Bidder in his bid and according to the proposal, plans, and specifications prepared by said Department, which proposal, plans, and specifications show the details covering this project, and hereby become a part of this contract.

The published volume entitled *North Carolina Department of Transportation, Raleigh, Standard Specifications for Roads and Structures, January 2018* with all amendments and supplements thereto, is by reference incorporated into and made a part of this contract; that, except as herein modified, all the construction and work included in this contract is to be done in accordance with the specifications contained in said volume, and amendments and supplements thereto, under the direction of the Engineer.

If the proposal is accepted and the award is made, the contract is valid only when signed either by the Contract Officer or such other person as may be designated by the Secretary to sign for the Department of Transportation. The conditions and provisions herein cannot be changed except over the signature of the said Contract Officer or Division Engineer.

The quantities shown in the itemized proposal for the project are considered to be approximate only and are given as the basis for comparison of bids. The Department of Transportation may increase or decrease the quantity of any item or portion of the work as may be deemed necessary or expedient.

An increase or decrease in the quantity of an item will not be regarded as sufficient ground for an increase or decrease in the unit prices, nor in the time allowed for the completion of the work, except as provided for the contract.

Accompanying this bid is a bid bond secured by a corporate surety, or certified check payable to the order of the Department of Transportation, for five percent of the total bid price, which deposit is to be forfeited as liquidated damages in case this bid is accepted and the Bidder shall fail to provide the required payment and performance bonds with the Department of Transportation, under the condition of this proposal, within 14 calendar days after the written notice of award is received by him, as provided in the Standard Specifications; otherwise said deposit will be returned to the Bidder.

TABLE OF CONTENTS

COVER SHEET
PROPOSAL SHEET

THIS CONTRACT IS FOR TIP U-5710A CONTRACT ID DC00277 FOR GRADING, PAVING, DRAINAGE AND SIGNALS TYPE OF WORK IN NEW HANOVER COUNTY.

SPECIAL PROVISIONS

PROJECT SPECIAL PROVISIONS..... 1
GENERAL..... 1
BOND REQUIREMENTS: 1
CONTRACT TIME AND LIQUIDATED DAMAGES: 1
INTERMEDIATE CONTRACT TIME NUMBER 1 AND LIQUIDATED DAMAGES: 1
INTERMEDIATE CONTRACT TIME NUMBER 2 AND LIQUIDATED DAMAGES: 2
INTERMEDIATE CONTRACT TIME NUMBER 3 AND LIQUIDATED DAMAGES: 2
PERMANENT VEGETATION ESTABLISHMENT: 4
NO MAJOR CONTRACT ITEMS: 4
SPECIALTY ITEMS:..... 5
FUEL PRICE ADJUSTMENT:..... 5
SCHEDULE OF ESTIMATED COMPLETION PROGRESS:..... 6
DISADVANTAGED BUSINESS ENTERPRISE (DIVISIONS):..... 6
CERTIFICATION FOR FEDERAL-AID CONTRACTS: 18
CONTRACTOR'S LICENSE REQUIREMENTS: 19
USE OF UNMANNED AIRCRAFT SYSTEM (UAS): 19
U.S. DEPARTMENT OF TRANSPORTATION HOTLINE: 19
CARGO PREFERENCE ACT: 20
SUBSURFACE INFORMATION:..... 20
COOPERATION BETWEEN CONTRACTORS:..... 20
ELECTRONIC BIDDING:..... 20
TWELVE MONTH GUARANTEE: 21
EROSION AND SEDIMENT CONTROL/STORMWATER CERTIFICATION: 22
PROCEDURE FOR MONITORING BORROW PIT DISCHARGE:..... 26
PROJECT SPECIAL PROVISIONS 28
ROADWAY 28
NOTES TO CONTRACTOR: 28
CONSTRUCTION SEQUENCE:..... 28
BURNING RESTRICTIONS: 28
BORROW EXCAVATION (In Place or Truck Measurement): 28
MANUFACTURED QUARRY FINES IN EMBANKMENTS: 28
SHOULDER CLEANUP:.....
STORMWATER POND GRADING
DRAWDOWN STRUCTURE:
VINYL FENCE PROVISIONS:.....
OYSTER SHELL SPECIAL VALLEY GUTTER
OYSTER SHELL 6" CONCRETE DRIVEWAY
POLYPROPYLENE CULVERT PIPE: 37

AUTOMATED FINE GRADING:.....	38
AGGREGATE SUBGRADE:	38
STABILIZATION OF COASTAL PLAIN SANDS:.....	39
INCIDENTAL STONE BASE:	40
PRICE ADJUSTMENT - ASPHALT BINDER FOR PLANT MIX:	40
FINAL SURFACE TESTING NOT REQUIRED:	40
ASPHALT CONCRETE PLANT MIX PAVEMENTS:.....	40
AUTOMATED MACHINE GUIDANCE.....	44
FOUNDATIONS AND ANCHOR ROD ASSEMBLIES FOR METAL POLES:.....	45
LAW ENFORCEMENT	TC-1
LONGITUDINAL CHANNELIZING CURB SYSTEM.....	54
EXTRUDED THERMOPLASTIC PAVEMENT MARKING THICKNESS	
THERMOPLASTIC PAVEMENT MARKING MATERIAL – COLOR TESTING:	56
PERMANENT SEEDING AND MULCHING:.....	56
AVAILABILITY OF FUNDS – TERMINATION OF CONTRACTS	57
NC DOT GENERAL SEED SPECIFICATION FOR SEED QUALITY	58
ERRATA	61
PLANT AND PEST QUARANTINES	62
TITLE VI AND NONDISCRIMINATION:	63
MINORITY AND FEMALE EMPLOYMENT REQUIREMENTS	70
REQUIRED CONTRACT PROVISIONS FEDERAL - AID CONSTRUCTION CONTRACTS.....	73
ON-THE-JOB TRAINING.....	82
MINIMUM WAGES	85
GENERAL DECISION NC190090 01/04/2019 NC90.....	85
PERMITS.....	90
NATIONWIDE & WATER QUALITY PERMIT PKG.....	
EROSION CONTROL PROVISIONS.....	EC-1
VERTICAL PANEL (OM3-L).....	
SIGNALS & INTELLIGENT TRANS. SYSTEMS	TS-1
MSE RETAINING WALL.....	GT-0.1
UTILITY BY OTHERS (UbO)	UbO-1
LISTING OF DBE SUBCONTRACTORS.....	97
CONTRACT PAYMENT BOND	99
CONTRACT PERFORMANCE BOND	108
BID BOND	117
ADDENDUM(S)	124
AWARD LIMITS ON MULTIPLE PROJECTS	125
EXECUTION OF BID.....	126
DEBARMENT CERTIFICATION	133

ITEMIZED PROPOSAL FOR CONTRACT DC00277 (BID FORM)

INSTRUCTIONS TO BIDDERS

**PLEASE READ ALL INSTRUCTIONS CAREFULLY
BEFORE PREPARING AND SUBMITTING YOUR BID.**

All bids shall be prepared and submitted in accordance with the following requirements. Failure to comply with any requirement may cause the bid to be considered irregular and may be grounds for rejection of the bid.

For preparing and submitting the bid electronically, refer to Article 102-8(B) of the *2018 Standard Specifications*.

Bidders that bid electronically on Raleigh Central-Let projects will need a separate Digital Signature from the approved electronic bidding provider for Division Contracts.

ELECTRONIC ON-LINE BID:

1. Download entire proposal from Connect NCDOT website. Download the electronic submittal file from the approved electronic bidding provider website.
2. Prepare and submit the electronic submittal file using the approved electronic bidding provider software.
3. Electronic bidding software necessary for electronic bid preparation may be downloaded from the Connect NCDOT website at: <https://connect.ncdot.gov/letting/Pages/Electronic-Bidding.aspx> or from the approved electronic bidding provider website.

PROJECT SPECIAL PROVISIONS**GENERAL****BOND REQUIREMENTS:**

(06-01-16)

102-8, 102-10

SPD 01-420A

A Bid Bond is required in accordance with Article 102-10 of the *2018 Standard Specifications for Roads and Structures*.

Contract Payment and Performance Bonds are required in accordance with Article 103-7 of the *2018 Standard Specifications for Roads and Structures*.

CONTRACT TIME AND LIQUIDATED DAMAGES:

(8-15-00) (Rev. 12-18-07)

108

SP1 G07 A

The date of availability for this contract is **March 2, 2020**, except that work in jurisdictional waters and wetlands shall not begin until a meeting between the DOT, Regulatory Agencies, and the Contractor is held as stipulated in the permits contained elsewhere in this proposal. This delay in availability has been considered in determining the contract time for this project.

The completion date for this contract is **December 3, 2021**.

Except where otherwise provided by the contract, observation periods required by the contract will not be a part of the work to be completed by the completion date and/or intermediate contract times stated in the contract. The acceptable completion of the observation periods that extend beyond the final completion date shall be a part of the work covered by the performance and payment bonds.

The liquidated damages for this contract are **Two Hundred Dollars (\$ 200.00)** per calendar day. These liquidated damages will not be cumulative with any liquidated damages which may become chargeable under Intermediate Contract Time Number 1.

INTERMEDIATE CONTRACT TIME NUMBER 1 AND LIQUIDATED DAMAGES:

(7-1-95) (Rev. 2-21-12)

108

SP1 G13 A

Except for that work required under the Project Special Provisions entitled *Planting, Reforestation* and/or *Permanent Vegetation Establishment*, included elsewhere in this proposal, the Contractor will be required to complete all work included in this contract and shall place and maintain traffic on same.

The date of availability for this intermediate contract time is **March 2, 2020**.

The completion date for this intermediate contract time is **June 4, 2021**.

The liquidated damages for this intermediate contract time are **One Thousand Dollars (\$ 1,000.00)** per calendar day.

Upon apparent completion of all the work required to be completed by this intermediate date, a final inspection will be held in accordance with Article 105-17 and upon acceptance, the Department will assume responsibility for the maintenance of all work except *Planting, Reforestation* and/or *Permanent Vegetation Establishment*. The Contractor will be responsible for and shall make corrections of all damages to the

completed roadway caused by his planting operations, whether occurring prior to or after placing traffic through the project.

INTERMEDIATE CONTRACT TIME NUMBER 2 AND LIQUIDATED DAMAGES:

(5-21-13)

108

SP1 G14 I

The Contractor shall complete the work required of installing each new inductive loop after the removal of each existing loop by the milling, patching or resurfacing operations and shall place and maintain traffic on same.

The date of availability for this intermediate contract time for each inductive loop installation will be the date when the Contractor elects to disturb the existing inductive loop.

The completion date for this intermediate contract time for each inductive loop installation will be the date which is seven (7) consecutive calendar days after the date of availability.

If any inductive loop is damaged in the process of installing concrete work on this project, the Contractor will repair the damaged loop within seven (7) consecutive calendar days at no additional cost to NCDOT.

The liquidated damages are **One Thousand Dollars (\$ 1,000.00)** per calendar day.

INTERMEDIATE CONTRACT TIME NUMBER 3 AND LIQUIDATED DAMAGES:

(2-20-07)

108

SP1 G14 A

The Contractor shall complete the required work of installing, maintaining, and removing the traffic control devices for lane closures and restoring traffic to the existing traffic pattern. The Contractor shall not close or narrow a lane of traffic on **the following locations** during the following time restrictions:

DAY AND TIME RESTRICTIONS

**-Y1- (US 17/Military Cutoff Rd) and -Y4- (US 74/Eastwood Rd) Sunday through Saturday
6:00 a.m. to 9:00 p.m.**

NO WORK ALLOWED

**-L- (Drysdale Dr. Ext.) Sunday through Saturday
9:00 p.m. to 6:00 a.m.**

In addition, the Contractor shall not close or narrow a lane of traffic on **any road**, detain and/or alter the traffic flow on or during holidays, holiday weekends, special events, or any other time when traffic is unusually heavy, including the following schedules:

HOLIDAY AND HOLIDAY WEEKEND LANE CLOSURE RESTRICTIONS

1. For **unexpected occurrence** that creates unusually high traffic volumes, as directed by the Engineer.
2. For **New Year's Day**, between the hours of **6:00 a.m.** December 31st and **9:00 p.m.** January 2nd. If New Year's Day is on a Friday, Saturday, Sunday or Monday, then until **9:00 p.m.** the following Tuesday.

3. For **Easter**, between the hours of **6:00 a.m.** Thursday and **9:00 p.m.** Monday.
4. For **Memorial Day**, between the hours of **6:00 a.m.** Friday and **9:00 p.m.** Tuesday.
5. For **Independence Day**, between the hours of **6:00 a.m.** the day before Independence Day and **9:00 p.m.** the day after Independence Day.

If **Independence Day** is on a Friday, Saturday, Sunday or Monday, then between the hours of **6:00 a.m.** the Thursday before Independence Day and **9:00 p.m.** the Tuesday after Independence Day.
6. For **Labor Day**, between the hours of **6:00 a.m.** Friday and **9:00 p.m.** Tuesday.
7. For **Thanksgiving Day**, between the hours of **6:00 a.m.** Tuesday and **9:00 p.m.** Monday.
8. For **Christmas**, between the hours of **6:00 a.m.** the Friday before the week of Christmas Day and **9:00 p.m.** the following Tuesday after the week of Christmas Day.
9. For **NHRMC Wilmington Marathon Madness** between the hours of **6:00 a.m.** Friday March 20th, 2020 and **9:00 p.m.** Saturday March 21st, 2020. Apply the same hour & day restrictions for NHRMC Wilmington Marathon Madness 2021 (Dates to be determined).
10. For **Azalea Sprint Triathlon** between the hours of **6:00 a.m.** and **9:00 p.m.** Sunday March 29th, 2020. Apply the same hour & day restrictions for **the Azalea Sprint Triathlon 2021** (Dates to be determined).
11. For **North Carolina Azalea Festival**, between the hours of **6:00 a.m.** Wednesday April 1st, 2020 and **9:00 p.m.** Sunday, April 5th, 2020. Apply the same hour & day restrictions for NC Azalea Festival 2021 (Dates to be determined).
12. For **River to Sea Bike Ride** between the hours of **6:00 a.m.** and **9:00 p.m.** Saturday May 2nd, 2020. Apply the same hour & day restrictions for the River to Sea Bike Ride 2021 (Dates to be determined).
13. For **YMCA Wrightsville Beach Sprint Triathlon** between the hours of **6:00 a.m.** and **9:00 p.m.** Saturday September 19th, 2020.
14. For **Wilmington Riverfest** – Between the hours of **6:00 AM** Thursday, **October 1st, 2020** and **9:00 PM** Sunday, **October 4th, 2020**.
15. For the **Ironman 70.3 North Carolina** between the hours of **6:00 a.m.** and **9:00 p.m.** Saturday October 17th, 2020.

16. For **the Race 13.1** between **three (3)** hours before the start and **three (3)** hours after the end of the event.

Holidays and holiday weekends shall include New Year's, Easter, Memorial Day, Independence Day, Labor Day, Thanksgiving, and Christmas. The Contractor shall schedule his work so that lane closures will not be required during these periods, unless otherwise directed by the Engineer.

The time of availability for this intermediate contract work shall be the time the Contractor begins to install all traffic control devices for lane closures according to the time restrictions listed herein.

The completion time for this intermediate contract work shall be the time the Contractor is required to complete the removal of all traffic control devices for lane closures according to the time restrictions stated above and place traffic in the existing traffic pattern.

The liquidated damages are **One Thousand Dollars (\$ 1,000.00)** per hour.

PERMANENT VEGETATION ESTABLISHMENT:

(2-16-12) (Rev. 10-15-13)

104

SP1 G16

Establish a permanent stand of the vegetation mixture shown in the contract. During the period between initial vegetation planting and final project acceptance, perform all work necessary to establish permanent vegetation on all erodible areas within the project limits, as well as, in borrow and waste pits. This work shall include erosion control device maintenance and installation, repair seeding and mulching, supplemental seeding and mulching, mowing, and fertilizer topdressing, as directed. All work shall be performed in accordance with the applicable section of the *2018 Standard Specifications*. All work required for initial vegetation planting shall be performed as a part of the work necessary for the completion and acceptance of the Intermediate Contract Time (ICT). Between the time of ICT and Final Project acceptance, or otherwise referred to as the vegetation establishment period, the Department will be responsible for preparing the required National Pollutant Discharge Elimination System (NPDES) inspection records.

Once the Engineer has determined that the permanent vegetation establishment requirement has been achieved at an 80% vegetation density (the amount of established vegetation per given area to stabilize the soil) and no erodible areas exist within the project limits, the Contractor will be notified to remove the remaining erosion control devices that are no longer needed. The Contractor will be responsible for, and shall correct any areas disturbed by operations performed in permanent vegetation establishment and the removal of temporary erosion control measures, whether occurring prior to or after placing traffic on the project.

Payment for *Response for Erosion Control, Seeding and Mulching, Repair Seeding, Supplemental Seeding, Mowing, Fertilizer Topdressing, Silt Excavation, and Stone for Erosion Control* will be made at contract unit prices for the affected items. Work required that is not represented by contract line items will be paid in accordance with Articles 104-7 or 104-3 of the *2018 Standard Specifications*. No additional compensation will be made for maintenance and removal of temporary erosion control items.

NO MAJOR CONTRACT ITEMS:

(2-19-02) (Rev. 8-21-07)

104

SP1 G31

None of the items included in this contract will be major items.

SPECIALTY ITEMS:

(7-1-95)(Rev. 1-17-12)

108-6

SP1 G37

Items listed below will be the specialty items for this contract (see Article 108-6 of the *2018 Standard Specifications*).

Line #	Description
57 - 61	Fencing
65 - 71	Signing
84 - 88, 99 - 100	Long-Life Pavement Markings
101	Permanent Pavement Markers
102 - 131	Erosion Control
132 - 170	Signals/ITS System

FUEL PRICE ADJUSTMENT:

(11-15-05) (Rev. 2-18-14)

109-8

SP1 G43

Revise the *2018 Standard Specifications* as follows:

Page 1-87, Article 109-8, Fuel Price Adjustments, add the following:

The base index price for DIESEL #2 FUEL is **\$ 1.9854** per gallon. Where any of the following are included as pay items in the contract, they will be eligible for fuel price adjustment.

The pay items and the fuel factor used in calculating adjustments to be made will be as follows:

Description	Units	Fuel Usage Factor Diesel
Unclassified Excavation	Gal/CY	0.29
Borrow Excavation	Gal/CY	0.29
Class IV Subgrade Stabilization	Gal/Ton	0.55
Aggregate Base Course	Gal/Ton	0.55
Sub-Ballast	Gal/Ton	0.55
Asphalt Concrete Base Course, Type _____	Gal/Ton	2.90
Asphalt Concrete Intermediate Course, Type _____	Gal/Ton	2.90
Asphalt Concrete Surface Course, Type _____	Gal/Ton	2.90
Open-Graded Asphalt Friction Course	Gal/Ton	2.90
Permeable Asphalt Drainage Course, Type _____	Gal/Ton	2.90
Sand Asphalt Surface Course, Type _____	Gal/Ton	2.90
Aggregate for Cement Treated Base Course	Gal/Ton	0.55
Portland Cement for Cement Treated Base Course	Gal/Ton	0.55
____ " Portland Cement Concrete Pavement	Gal/SY	0.245
Concrete Shoulders Adjacent to ____ " Pavement	Gal/SY	0.245

SCHEDULE OF ESTIMATED COMPLETION PROGRESS:

(7-15-08) (Rev. 5-13-19)

108-2

SP1 G58

The Contractor's attention is directed to the Standard Special Provision entitled *Availability of Funds Termination of Contracts* included elsewhere in this proposal. The Department of Transportation's schedule of estimated completion progress for this project as required by that Standard Special Provision is as follows:

	<u>Fiscal Year</u>	<u>Progress (% of Dollar Value)</u>
2020	(7/01/19 - 6/30/20)	27% of Total Amount Bid
2021	(7/01/20 - 6/30/21)	73% of Total Amount Bid
2022	(7/01/21 - 6/30/22)	0% of Total Amount Bid
2023	(7/01/22 - 6/30/23)	0% of Total Amount Bid
2024	(7/01/23 - 6/30/24)	0% of Total Amount Bid

The Contractor shall also furnish his own progress schedule in accordance with Article 108-2 of the *2018 Standard Specifications*. Any acceleration of the progress as shown by the Contractor's progress schedule over the progress as shown above shall be subject to the approval of the Engineer.

DISADVANTAGED BUSINESS ENTERPRISE (DIVISIONS):

(10-16-07)(Rev.2-19-19)

102-15(J)

SP1 G62

Description

The purpose of this Special Provision is to carry out the U.S. Department of Transportation's policy of ensuring nondiscrimination in the award and administration of contracts financed in whole or in part with Federal funds. This provision is guided by 49 CFR Part 26.

Definitions

Additional DBE Subcontractors - Any DBE submitted at the time of bid that will not be used to meet the DBE goal. No submittal of a Letter of Intent is required.

Committed DBE Subcontractor - Any DBE submitted at the time of bid that is being used to meet the DBE goal by submission of a Letter of Intent. Or any DBE used as a replacement for a previously committed DBE firm.

Contract Goal Requirement - The approved DBE participation at time of award, but not greater than the advertised contract goal.

DBE Goal - A portion of the total contract, expressed as a percentage, that is to be performed by committed DBE subcontractor(s).

Disadvantaged Business Enterprise (DBE) - A firm certified as a Disadvantaged Business Enterprise through the North Carolina Unified Certification Program.

Goal Confirmation Letter - Written documentation from the Department to the bidder confirming the Contractor's approved, committed DBE participation along with a listing of the committed DBE firms.

Manufacturer - A firm that operates or maintains a factory or establishment that produces on the premises, the materials or supplies obtained by the Contractor.

Regular Dealer - A firm that owns, operates, or maintains a store, warehouse, or other establishment in which the materials or supplies required for the performance of the contract are bought, kept in stock, and regularly sold to the public in the usual course of business. A regular dealer engages in, as its principal business and in its own name, the purchase and sale or lease of the products in question. A regular dealer in such bulk items as steel, cement, gravel, stone, and petroleum products need not keep such products in stock, if it owns and operates distribution equipment for the products. Brokers and packagers are not regarded as manufacturers or regular dealers within the meaning of this section.

Replacement / Substitution – A full or partial reduction in the amount of work subcontracted to a committed (or an approved substitute) DBE firm.

North Carolina Unified Certification Program (NCUCP) - A program that provides comprehensive services and information to applicants for DBE certification, such that an applicant is required to apply only once for a DBE certification that will be honored by all recipients of USDOT funds in the state and not limited to the Department of Transportation only. The Certification Program is in accordance with 49 CFR Part 26.

United States Department of Transportation (USDOT) - Federal agency responsible for issuing regulations (49 CFR Part 26) and official guidance for the DBE program.

Forms and Websites Referenced in this Provision

DBE Payment Tracking System - On-line system in which the Contractor enters the payments made to DBE subcontractors who have performed work on the project.
<https://apps.dot.state.nc.us/Vendor/PaymentTracking/>

DBE-IS Subcontractor Payment Information - Form for reporting the payments made to all DBE firms working on the project. This form is for paper bid projects only.
<https://connect.ncdot.gov/business/Turnpike/Documents/Form%20DBE-IS%20Subcontractor%20Payment%20Information.pdf>

RF-1 DBE Replacement Request Form - Form for replacing a committed DBE.
<http://connect.ncdot.gov/projects/construction/Construction%20Forms/DBE%20MBE%20WBE%20Replacement%20Request%20Form.pdf>

SAF Subcontract Approval Form - Form required for approval to sublet the contract.
<http://connect.ncdot.gov/projects/construction/Construction%20Forms/Subcontract%20Approval%20Form%20Rev.%202012.zip>

JC-1 Joint Check Notification Form - Form and procedures for joint check notification. The form acts as a written joint check agreement among the parties providing full and prompt disclosure of the expected use of joint checks.
<http://connect.ncdot.gov/projects/construction/Construction%20Forms/Joint%20Check%20Notification%20Form.pdf>

Letter of Intent - Form signed by the Contractor and the DBE subcontractor, manufacturer or regular dealer that affirms that a portion of said contract is going to be performed by the signed DBE for the estimated amount (based on quantities and unit prices) listed at the time of bid.

<http://connect.ncdot.gov/letting/LetCentral/Letter%20of%20Intent%20to%20Perform%20as%20a%20Subcontractor.pdf>

Listing of DBE Subcontractors Form - Form for entering DBE subcontractors on a project that will meet this DBE goal. This form is for paper bids only.

[http://connect.ncdot.gov/municipalities/Bid%20Proposals%20for%20LGA%20Content/08%20DBE%20Subcontractors%20\(Federal\).docx](http://connect.ncdot.gov/municipalities/Bid%20Proposals%20for%20LGA%20Content/08%20DBE%20Subcontractors%20(Federal).docx)

Subcontractor Quote Comparison Sheet - Spreadsheet for showing all subcontractor quotes in the work areas where DBEs quoted on the project. This sheet is submitted with good faith effort packages.

<http://connect.ncdot.gov/business/SmallBusiness/Documents/DBE%20Subcontractor%20Quote%20Comparison%20Example.xls>

DBE Goal

The following DBE goal for participation by Disadvantaged Business Enterprises is established for this contract:

Disadvantaged Business Enterprises **5.0 %**

- (A) *If the DBE goal is more than zero*, the Contractor shall exercise all necessary and reasonable steps to ensure that DBEs participate in at least the percent of the contract as set forth above as the DBE goal.
- (B) *If the DBE goal is zero*, the Contractor shall make an effort to recruit and use DBEs during the performance of the contract. Any DBE participation obtained shall be reported to the Department.

Directory of Transportation Firms (Directory)

Real-time information is available about firms doing business with the Department and firms that are certified through NCUCP in the Directory of Transportation Firms. Only firms identified in the Directory as DBE certified shall be used to meet the DBE goal. The Directory can be found at the following link. [https:// www.ebs.nc.gov/VendorDirectory/default.html](https://www.ebs.nc.gov/VendorDirectory/default.html)

The listing of an individual firm in the directory shall not be construed as an endorsement of the firm's capability to perform certain work.

Listing of DBE Subcontractors

At the time of bid, bidders shall submit all DBE participation that they anticipate to use during the life of the contract. Only those identified to meet the DBE goal will be considered committed, even though the listing shall include both committed DBE subcontractors and additional DBE subcontractors. Additional DBE subcontractor participation submitted at the time of bid will be used toward the Department's overall race-neutral goal. Only those firms with current DBE certification at the time of bid opening will be acceptable for listing in the bidder's submittal of DBE participation. The Contractor shall indicate the following required information:

- (A) Electronic Bids

Bidders shall submit a listing of DBE participation in the appropriate section of the electronic submittal file.

- (1) Submit the names and addresses of DBE firms identified to participate in the contract. If the bidder uses the updated listing of DBE firms shown in the electronic submittal file, the bidder may use the dropdown menu to access the name and address of the DBE firm.
- (2) Submit the contract line numbers of work to be performed by each DBE firm. When no figures or firms are entered, the bidder will be considered to have no DBE participation.
- (3) The bidder shall be responsible for ensuring that the DBE is certified at the time of bid by checking the Directory of Transportation Firms. If the firm is not certified at the time of the bid-letting, that DBE's participation will not count towards achieving the DBE goal.

(B) Paper Bids

- (1) *If the DBE goal is more than zero,*
 - (a) Bidders, at the time the bid proposal is submitted, shall submit a listing of DBE participation, including the names and addresses on *Listing of DBE Subcontractors* contained elsewhere in the contract documents in order for the bid to be considered responsive. Bidders shall indicate the total dollar value of the DBE participation for the contract.
 - (b) If bidders have no DBE participation, they shall indicate this on the *Listing of DBE Subcontractors* by entering the word "None" or the number "0." This form shall be completed in its entirety. **Blank forms will not be deemed to represent zero participation.** Bids submitted that do not have DBE participation indicated on the appropriate form will not be read publicly during the opening of bids. The Department will not consider these bids for award and the proposal will be rejected.
 - (c) The bidder shall be responsible for ensuring that the DBE is certified at the time of bid by checking the Directory of Transportation Firms. If the firm is not certified at the time of the bid-letting, that DBE's participation will not count towards achieving the DBE goal.
- (2) *If the DBE goal is zero,* entries on the *Listing of DBE Subcontractors* are not required, however any DBE participation that is achieved during the project shall be reported in accordance with requirements contained elsewhere in the special provision.

DBE Prime Contractor

When a certified DBE firm bids on a contract that contains a DBE goal, the DBE firm is responsible for meeting the goal or making good faith efforts to meet the goal, just like any other bidder. In most cases, a DBE bidder on a contract will meet the DBE goal by virtue of the work it performs on the contract with its own forces. However, all the work that is performed by the DBE bidder and any other DBE subcontractors will count toward the DBE goal. The DBE bidder shall list itself along with any DBE subcontractors, if any, in order to receive credit toward the DBE goal.

For example, if the DBE goal is 45% and the DBE bidder will only perform 40% of the contract work, the prime will list itself at 40%, and the additional 5% shall be obtained through additional DBE participation with DBE subcontractors or documented through a good faith effort.

DBE prime contractors shall also follow Sections A or B listed under *Listing of DBE Subcontractor* just as a non-DBE bidder would.

Written Documentation – Letter of Intent

The bidder shall submit written documentation for each DBE that will be used to meet the DBE goal of the contract, indicating the bidder's commitment to use the DBE in the contract. This documentation shall be submitted on the Department's form titled *Letter of Intent*.

The documentation shall be received in the office of the Engineer no later than 2:00 p.m. of the fifth calendar day following opening of bids, unless the fifth day falls on Saturday, Sunday or an official state holiday. In that situation, it is due in the office of the Engineer no later than 10:00 a.m. on the next official state business day.

If the bidder fails to submit the Letter of Intent from each committed DBE to be used toward the DBE goal, or if the form is incomplete (i.e. both signatures are not present), the DBE participation will not count toward meeting the DBE goal. If the lack of this participation drops the commitment below the DBE goal, the Contractor shall submit evidence of good faith efforts, completed in its entirety, to the Engineer no later than 2:00 p.m. on the eighth calendar day following opening of bids, unless the eighth day falls on Saturday, Sunday or an official state holiday. In that situation, it is due in the office of the Engineer no later than 10:00 a.m. on the next official state business day.

Submission of Good Faith Effort

If the bidder fails to meet or exceed the DBE goal the apparent lowest responsive bidder shall submit to the Department documentation of adequate good faith efforts made to reach the DBE goal.

One complete set and **5** copies of this information shall be received in the office of the Engineer no later than 2:00 p.m. of the fifth calendar day following opening of bids, unless the fifth day falls on Saturday, Sunday or an official state holiday. In that situation, it is due in the office of the Engineer no later than 10:00 a.m. on the next official state business day.

Note: Where the information submitted includes repetitious solicitation letters, it will be acceptable to submit a representative letter along with a distribution list of the firms that were solicited. Documentation of DBE quotations shall be a part of the good faith effort submittal. This documentation may include written subcontractor quotations, telephone log notations of verbal quotations, or other types of quotation documentation.

Consideration of Good Faith Effort for Projects with DBE Goals More Than Zero

Adequate good faith efforts mean that the bidder took all necessary and reasonable steps to achieve the goal which, by their scope, intensity, and appropriateness, could reasonably be expected to obtain sufficient DBE participation. Adequate good faith efforts also mean that the bidder actively and aggressively sought DBE participation. Mere *pro forma* efforts are not considered good faith efforts.

The Department will consider the quality, quantity, and intensity of the different kinds of efforts a bidder has made. Listed below are examples of the types of actions a bidder will take in making a good faith effort to meet the goal and are not intended to be exclusive or exhaustive, nor is it intended to be a mandatory checklist.

- (A) Soliciting through all reasonable and available means (e.g. attendance at pre-bid meetings, advertising, written notices, use of verifiable electronic means through the use of the NCDOT Directory of Transportation Firms) the interest of all certified DBEs who have the capability to perform the work of the contract. The bidder must solicit this interest within at least 10 days prior to bid opening to allow the DBEs to respond to the solicitation. Solicitation shall provide the opportunity to DBEs within the Division and surrounding Divisions where the project is located. The bidder must determine with certainty if the DBEs are interested by taking appropriate steps to follow up initial solicitations.
- (B) Selecting portions of the work to be performed by DBEs in order to increase the likelihood that the DBE goals will be achieved.
 - (1) Where appropriate, break out contract work items into economically feasible units to facilitate DBE participation, even when the prime contractor might otherwise prefer to perform these work items with its own forces.
 - (2) Negotiate with subcontractors to assume part of the responsibility to meet the contract DBE goal when the work to be sublet includes potential for DBE participation (2nd and 3rd tier subcontractors).
- (C) Providing interested DBEs with adequate information about the plans, specifications, and requirements of the contract in a timely manner to assist them in responding to a solicitation.
- (D)
 - (1) Negotiating in good faith with interested DBEs. It is the bidder's responsibility to make a portion of the work available to DBE subcontractors and suppliers and to select those portions of the work or material needs consistent with the available DBE subcontractors and suppliers, so as to facilitate DBE participation. Evidence of such negotiation includes the names, addresses, and telephone numbers of DBEs that were considered; a description of the information provided regarding the plans and specifications for the work selected for subcontracting; and evidence as to why additional agreements could not be reached for DBEs to perform the work.
 - (2) A bidder using good business judgment would consider a number of factors in negotiating with subcontractors, including DBE subcontractors, and would take a firm's price and capabilities as well as contract goals into consideration. However, the fact that there may be some additional costs involved in finding and using DBEs is not in itself sufficient reason for a bidder's failure to meet the contract DBE goal, as long as such costs are reasonable. Also, the ability or desire of a prime contractor to perform the work of a contract with its own organization does not relieve the bidder of the responsibility to make good faith efforts. Bidding contractors are not, however, required to accept higher quotes from DBEs if the price difference is excessive or unreasonable.
- (E) Not rejecting DBEs as being unqualified without sound reasons based on a thorough investigation of their capabilities. The bidder's standing within its industry, membership in specific groups, organizations, or associates and political or social affiliations (for example, union vs. non-union employee status) are not legitimate causes for the rejection or non-solicitation of bids in the bidder's efforts to meet the project goal.

- (F) Making efforts to assist interested DBEs in obtaining bonding, lines of credit, or insurance as required by the recipient or bidder.
- (G) Making efforts to assist interested DBEs in obtaining necessary equipment, supplies, materials, or related assistance or services.
- (H) Effectively using the services of available minority/women community organizations; minority/women contractors' groups; Federal, State, and local minority/women business assistance offices; and other organizations as allowed on a case-by-case basis to provide assistance in the recruitment and placement of DBEs. Contact within 7 days from the bid opening the Business Opportunity and Work Force Development Unit at BOWD@ncdot.gov to give notification of the bidder's inability to get DBE quotes.
- (I) Any other evidence that the bidder submits which shows that the bidder has made reasonable good faith efforts to meet the DBE goal.

In addition, the Department may take into account the following:

- (1) Whether the bidder's documentation reflects a clear and realistic plan for achieving the DBE goal.
- (2) The bidders' past performance in meeting the DBE goals.
- (3) The performance of other bidders in meeting the DBE goal. For example, when the apparent successful bidder fails to meet the DBE goal, but others meet it, you may reasonably raise the question of whether, with additional reasonable efforts the apparent successful bidder could have met the goal. If the apparent successful bidder fails to meet the DBE goal, but meets or exceeds the average DBE participation obtained by other bidders, the Department may view this, in conjunction with other factors, as evidence of the apparent successful bidder having made a good faith effort.

If the Department does not award the contract to the apparent lowest responsive bidder, the Department reserves the right to award the contract to the next lowest responsive bidder that can satisfy to the Department that the DBE goal can be met or that an adequate good faith effort has been made to meet the DBE goal.

Non-Good Faith Appeal

The Engineer will notify the contractor verbally and in writing of non-good faith. A contractor may appeal a determination of non-good faith made by the Goal Compliance Committee. If a contractor wishes to appeal the determination made by the Committee, they shall provide written notification to the Engineer. The appeal shall be made within 2 business days of notification of the determination of non-good faith.

Counting DBE Participation Toward Meeting DBE Goal

- (A) Participation

The total dollar value of the participation by a committed DBE will be counted toward the contract goal requirement. The total dollar value of participation by a committed DBE will be based upon

the value of work actually performed by the DBE and the actual payments to DBE firms by the Contractor.

(B) Joint Checks

Prior notification of joint check use shall be required when counting DBE participation for services or purchases that involves the use of a joint check. Notification shall be through submission of Form JC-1 (*Joint Check Notification Form*) and the use of joint checks shall be in accordance with the Department's Joint Check Procedures.

(C) Subcontracts (Non-Trucking)

A DBE may enter into subcontracts. Work that a DBE subcontracts to another DBE firm may be counted toward the contract goal requirement. Work that a DBE subcontracts to a non-DBE firm does not count toward the contract goal requirement. If a DBE contractor or subcontractor subcontracts a significantly greater portion of the work of the contract than would be expected on the basis of standard industry practices, it shall be presumed that the DBE is not performing a commercially useful function. The DBE may present evidence to rebut this presumption to the Department. The Department's decision on the rebuttal of this presumption is subject to review by the Federal Highway Administration but is not administratively appealable to USDOT.

(D) Joint Venture

When a DBE performs as a participant in a joint venture, the Contractor may count toward its contract goal requirement a portion of the total value of participation with the DBE in the joint venture, that portion of the total dollar value being a distinct clearly defined portion of work that the DBE performs with its forces.

(E) Suppliers

A contractor may count toward its DBE requirement 60 percent of its expenditures for materials and supplies required to complete the contract and obtained from a DBE regular dealer and 100 percent of such expenditures from a DBE manufacturer.

(F) Manufacturers and Regular Dealers

A contractor may count toward its DBE requirement the following expenditures to DBE firms that are not manufacturers or regular dealers:

- (1) The fees or commissions charged by a DBE firm for providing a *bona fide* service, such as professional, technical, consultant, or managerial services, or for providing bonds or insurance specifically required for the performance of a DOT-assisted contract, provided the fees or commissions are determined to be reasonable and not excessive as compared with fees and commissions customarily allowed for similar services.
- (2) With respect to materials or supplies purchased from a DBE, which is neither a manufacturer nor a regular dealer, count the entire amount of fees or commissions charged for assistance in the procurement of the materials and supplies, or fees or transportation charges for the delivery of materials or supplies required on a job site (but not the cost of the materials and supplies themselves), provided the fees are determined to

be reasonable and not excessive as compared with fees customarily allowed for similar services.

Commercially Useful Function

(A) DBE Utilization

The Contractor may count toward its contract goal requirement only expenditures to DBEs that perform a commercially useful function in the work of a contract. A DBE performs a commercially useful function when it is responsible for execution of the work of the contract and is carrying out its responsibilities by actually performing, managing, and supervising the work involved. To perform a commercially useful function, the DBE shall also be responsible with respect to materials and supplies used on the contract, for negotiating price, determining quality and quantity, ordering the material and installing (where applicable) and paying for the material itself. To determine whether a DBE is performing a commercially useful function, the Department will evaluate the amount of work subcontracted, industry practices, whether the amount the firm is to be paid under the contract is commensurate with the work it is actually performing and the DBE credit claimed for its performance of the work, and any other relevant factors.

(B) DBE Utilization in Trucking

The following factors will be used to determine if a DBE trucking firm is performing a commercially useful function:

- (1) The DBE shall be responsible for the management and supervision of the entire trucking operation for which it is responsible on a particular contract, and there shall not be a contrived arrangement for the purpose of meeting DBE goals.
- (2) The DBE shall itself own and operate at least one fully licensed, insured, and operational truck used on the contract.
- (3) The DBE receives credit for the total value of the transportation services it provides on the contract using trucks it owns, insures, and operates using drivers it employs.
- (4) The DBE may subcontract the work to another DBE firm, including an owner-operator who is certified as a DBE. The DBE who subcontracts work to another DBE receives credit for the total value of the transportation services the subcontracted DBE provides on the contract.
- (5) The DBE may also subcontract the work to a non-DBE firm, including from an owner-operator. The DBE who subcontracts the work to a non-DBE is entitled to credit for the total value of transportation services provided by the non-DBE subcontractor not to exceed the value of transportation services provided by DBE-owned trucks on the contract. Additional participation by non-DBE subcontractors receives credit only for the fee or commission it receives as a result of the subcontract arrangement. The value of services performed under subcontract agreements between the DBE and the Contractor will not count towards the DBE contract requirement.
- (6) A DBE may lease truck(s) from an established equipment leasing business open to the general public. The lease must indicate that the DBE has exclusive use of and control over

the truck. This requirement does not preclude the leased truck from working for others during the term of the lease with the consent of the DBE, so long as the lease gives the DBE absolute priority for use of the leased truck. This type of lease may count toward the DBE's credit as long as the driver is under the DBE's payroll.

- (7) Subcontracted/leased trucks shall display clearly on the dashboard the name of the DBE that they are subcontracted/leased to and their own company name if it is not identified on the truck itself. Magnetic door signs are not permitted.

DBE Replacement

When a Contractor has relied on a commitment to a DBE subcontractor (or an approved substitute DBE subcontractor) to meet all or part of a contract goal requirement, the contractor shall not terminate the DBE subcontractor for convenience. This includes, but is not limited to, instances in which the Contractor seeks to perform the work of the terminated subcontractor with another DBE subcontractor, a non-DBE subcontractor, or with the Contractor's own forces or those of an affiliate.

The Contractor must give notice in writing both by certified mail and email to the DBE subcontractor, with a copy to the Engineer of its intent to request to terminate and/or substitute, and the reason for the request. The Contractor must give the DBE subcontractor five (5) business days to respond to the Contractor's Notice of Intent to Request Termination and/or Substitution. If the DBE subcontractor objects to the intended termination/substitution, the DBE, within five (5) business days must advise the Contractor and the Department of the reasons why the action should not be approved. The five-day notice period shall begin on the next business day after written notice is provided to the DBE subcontractor.

A committed DBE subcontractor may only be terminated after receiving the Department's written approval based upon a finding of good cause for the proposed termination and/or substitution. For purposes of this section, good cause shall include the following circumstances:

- (a) The listed DBE subcontractor fails or refuses to execute a written contract;
- (b) The listed DBE subcontractor fails or refuses to perform the work of its subcontract in a way consistent with normal industry standards. Provided, however, that good cause does not exist if the failure or refusal of the DBE subcontractor to perform its work on the subcontract results from the bad faith or discriminatory action of the prime contractor;
- (c) The listed DBE subcontractor fails or refuses to meet the prime contractor's reasonable, nondiscriminatory bond requirements;
- (d) The listed DBE subcontractor becomes bankrupt, insolvent, or exhibits credit unworthiness;
- (e) The listed DBE subcontractor is ineligible to work on public works projects because of suspension and debarment proceedings pursuant to 2 CFR Parts 180, 215 and 1,200 or applicable state law;
- (f) The listed DBE subcontractor is not a responsible contractor;
- (g) The listed DBE voluntarily withdraws from the project and provides written notice of withdrawal;
- (h) The listed DBE is ineligible to receive DBE credit for the type of work required;
- (i) A DBE owner dies or becomes disabled with the result that the listed DBE contractor is unable to complete its work on the contract;
- (j) Other documented good cause that compels the termination of the DBE subcontractor. Provided, that good cause does not exist if the prime contractor seeks to terminate a DBE

it relied upon to obtain the contract so that the prime contractor can self-perform the work for which the DBE contractor was engaged or so that the prime contractor can substitute another DBE or non-DBE contractor after contract award.

The Contractor shall comply with the following for replacement of a committed DBE:

(A) Performance Related Replacement

When a committed DBE is terminated for good cause as stated above, an additional DBE that was submitted at the time of bid may be used to fulfill the DBE commitment. A good faith effort will only be required for removing a committed DBE if there were no additional DBEs submitted at the time of bid to cover the same amount of work as the DBE that was terminated.

If a replacement DBE is not found that can perform at least the same amount of work as the terminated DBE, the Contractor shall submit a good faith effort documenting the steps taken. Such documentation shall include, but not be limited to, the following:

- (1) Copies of written notification to DBEs that their interest is solicited in contracting the work defaulted by the previous DBE or in subcontracting other items of work in the contract.
- (2) Efforts to negotiate with DBEs for specific subbids including, at a minimum:
 - (a) The names, addresses, and telephone numbers of DBEs who were contacted.
 - (b) A description of the information provided to DBEs regarding the plans and specifications for portions of the work to be performed.
- (3) A list of reasons why DBE quotes were not accepted.
- (4) Efforts made to assist the DBEs contacted, if needed, in obtaining bonding or insurance required by the Contractor.

(B) Decertification Replacement

- (1) When a committed DBE is decertified by the Department after the SAF (*Subcontract Approval Form*) has been received by the Department, the Department will not require the Contractor to solicit replacement DBE participation equal to the remaining work to be performed by the decertified firm. The participation equal to the remaining work performed by the decertified firm will count toward the contract goal requirement.
- (2) When a committed DBE is decertified prior to the Department receiving the SAF (*Subcontract Approval Form*) for the named DBE firm, the Contractor shall take all necessary and reasonable steps to replace the DBE subcontractor with another DBE subcontractor to perform at least the same amount of work to meet the DBE goal requirement. If a DBE firm is not found to do the same amount of work, a good faith effort must be submitted to NCDOT (see A herein for required documentation).

All requests for replacement of a committed DBE firm shall be submitted to the Engineer for approval on Form RF-1 (*DBE Replacement Request*). If the Contractor fails to follow this procedure, the Contractor may be disqualified from further bidding for a period of up to 6 months

Changes in the Work

When the Engineer makes changes that result in the reduction or elimination of work to be performed by a committed DBE, the Contractor will not be required to seek additional participation. When the Engineer makes changes that result in additional work to be performed by a DBE based upon the Contractor's commitment, the DBE shall participate in additional work to the same extent as the DBE participated in the original contract work.

When the Engineer makes changes that result in extra work, which has more than a minimal impact on the contract amount, the Contractor shall seek additional participation by DBEs unless otherwise approved by the Engineer.

When the Engineer makes changes that result in an alteration of plans or details of construction, and a portion or all of the work had been expected to be performed by a committed DBE, the Contractor shall seek participation by DBEs unless otherwise approved by the Engineer.

When the Contractor requests changes in the work that result in the reduction or elimination of work that the Contractor committed to be performed by a DBE, the Contractor shall seek additional participation by DBEs equal to the reduced DBE participation caused by the changes.

Reports and Documentation

A SAF (*Subcontract Approval Form*) shall be submitted for all work which is to be performed by a DBE subcontractor. The Department reserves the right to require copies of actual subcontract agreements involving DBE subcontractors.

When using transportation services to meet the contract commitment, the Contractor shall submit a proposed trucking plan in addition to the SAF. The plan shall be submitted prior to beginning construction on the project. The plan shall include the names of all trucking firms proposed for use, their certification type(s), the number of trucks owned by the firm, as well as the individual truck identification numbers, and the line item(s) being performed.

Within 30 calendar days of entering into an agreement with a DBE for materials, supplies or services, not otherwise documented by the SAF as specified above, the Contractor shall furnish the Engineer a copy of the agreement. The documentation shall also indicate the percentage (60% or 100%) of expenditures claimed for DBE credit.

Reporting Disadvantaged Business Enterprise Participation

The Contractor shall provide the Engineer with an accounting of payments made to all DBE firms, including material suppliers and contractors at all levels (prime, subcontractor, or second tier subcontractor). This accounting shall be furnished to the Engineer for any given month by the end of the following month. Failure to submit this information accordingly may result in the following action:

- (A) Withholding of money due in the next partial pay estimate; or
- (B) Removal of an approved contractor from the prequalified bidders' list or the removal of other entities from the approved subcontractors list.

While each contractor (prime, subcontractor, 2nd tier subcontractor) is responsible for accurate accounting of payments to DBEs, it shall be the prime contractor's responsibility to report all monthly and final payment information in the correct reporting manner.

Failure on the part of the Contractor to submit the required information in the time frame specified may result in the disqualification of that contractor and any affiliate companies from further bidding until the required information is submitted.

Failure on the part of any subcontractor to submit the required information in the time frame specified may result in the disqualification of that contractor and any affiliate companies from being approved for work on future projects until the required information is submitted.

Contractors reporting transportation services provided by non-DBE lessees shall evaluate the value of services provided during the month of the reporting period only.

At any time, the Engineer can request written verification of subcontractor payments.

The Contractor shall report the accounting of payments through the Department's DBE Payment Tracking System.

Failure to Meet Contract Requirements

Failure to meet contract requirements in accordance with Subarticle 102-15(J) of the *2018 Standard Specifications* may be cause to disqualify the Contractor.

CERTIFICATION FOR FEDERAL-AID CONTRACTS:

(3-21-90)

SP1 G85

The prospective participant certifies, by signing and submitting this bid or proposal, to the best of his or her knowledge and belief, that:

- (A) No Federal appropriated funds have been paid or will be paid, by or on behalf of the undersigned, to any person for influencing or attempting to influence an officer or employee of any Federal agency, a Member of Congress, an officer or employee of Congress, or an employee of a Member of Congress in connection with the awarding of any Federal contract, the making of any Federal grant, the making of any Federal loan, the entering into of any cooperative agreement, and the extension, continuation, renewal, amendment, or modification of any Federal contract, grant, loan, or cooperative agreement.
- (B) If any funds other than Federal appropriated funds have been paid or will be paid to any person for influencing or attempting to influence an officer or employee of any Federal agency, a Member of Congress, an officer or employee of Congress, or an employee of a Member of Congress in connection with this Federal contract, grant, loan, or cooperative agreement, the undersigned shall complete and submit Standard Form-LLL, *Disclosure Form to Report Lobbying*, in accordance with its instructions.

This certification is a material representation of fact upon which reliance was placed when this transaction was made or entered into. Submission of this certification is a prerequisite for making or entering into this transaction imposed by *Section 1352, Title 31, U.S. Code*. Any person who fails to file the required certification shall be subject to a civil penalty of not less than \$10,000 and not more than \$100,000 for each such failure.

The prospective participant also agrees by submitting his or her bid or proposal that he or she shall require that the language of this certification be included in all lower tier subcontracts, which exceed \$100,000 and that all such subrecipients shall certify and disclose accordingly.

CONTRACTOR'S LICENSE REQUIREMENTS:

(7-1-95)

102-14

SP1 G88

If the successful bidder does not hold the proper license to perform any plumbing, heating, air conditioning, or electrical work in this contract, he will be required to sublet such work to a contractor properly licensed in accordance with *Article 2 of Chapter 87 of the General Statutes* (licensing of heating, plumbing, and air conditioning contractors) and *Article 4 of Chapter 87 of the General Statutes* (licensing of electrical contractors).

USE OF UNMANNED AIRCRAFT SYSTEM (UAS):

(8-20-19)

SP1 G092

The Contractor shall adhere to all Federal, State and Local regulations and guidelines for the use of Unmanned Aircraft Systems (UAS). This includes but is not limited to US 14 CFR Part 107 *Small UAS Rule*, NC GS 15A-300.2 *Regulation of launch and recovery sites*, NC GS 63-95 *Training required for the operation of unmanned aircraft systems*, NC GS 63-96 *Permit required for commercial operation of unmanned aircraft system*, and NCDOT UAS Policy. The required operator certifications include possessing a current Federal Aviation Administration (FAA) Remote Pilot Certificate, a NC UAS Operator Permit as well as operating a UAS registered with the FAA.

Prior to beginning operations, the Contractor shall complete the NCDOT UAS – Flight Operation Approval Form and submit it to the Engineer for approval. All UAS operations shall be approved by the Engineer prior to beginning the operations.

All contractors or subcontractors operating UAS shall have UAS specific general liability insurance to cover all operations under this contract.

The use of UAS is at the Contractor's discretion. No measurement or payment will be made for the use of UAS. In the event that the Department directs the Contractor to utilize UAS, payment will be in accordance with Article 104-7 Extra Work.

U.S. DEPARTMENT OF TRANSPORTATION HOTLINE:

(11-22-94)

108-5

SP1 G100

To report bid rigging activities call: **1-800-424-9071**

The U.S. Department of Transportation (DOT) operates the above toll-free hotline Monday through Friday, 8:00 a.m. to 5:00 p.m. eastern time. Anyone with knowledge of possible bid rigging, bidder collusion, or other fraudulent activities should use the hotline to report such activities.

The hotline is part of the DOT's continuing effort to identify and investigate highway construction contract fraud and abuse is operated under the direction of the DOT Inspector General. All information will be treated confidentially and caller anonymity will be respected.

CARGO PREFERENCE ACT:

(2-16-16)

Privately owned United States-flag commercial vessels transporting cargoes are subject to the Cargo Preference Act (CPA) of 1954 requirements and regulations found in 46 CFR 381.7. Contractors are directed to clause (b) of 46 CFR 381.7 as follows:

(b) Contractor and Subcontractor Clauses. "Use of United States-flag vessels: The contractor agrees-

" (1) To utilize privately owned United States-flag commercial vessels to ship at least 50 percent of the gross tonnage (computed separately for dry bulk carriers, dry cargo liners, and tankers) involved, whenever shipping any equipment, material, or commodities pursuant to this contract, to the extent such vessels are available at fair and reasonable rates for United States-flag commercial vessels.

(2) To furnish within 20 days following the date of loading for shipments originating within the United States or within 30 working days following the date of loading for shipments originating outside the United States a legible copy of a rated, 'on-board' commercial ocean bill-of-lading in English for each shipment of cargo described in paragraph (b) (1) of this section to both the Contracting Officer (through the prime contractor in the case of subcontractor bills-of-lading) and to the Division of National Cargo, Office of Market Development, Maritime Administration, Washington, DC 20590.

(3) To insert the substance of the provisions of this clause in all subcontracts issued pursuant to this contract."

SUBSURFACE INFORMATION:

(7-1-95)

450

SP1 G112 B

Subsurface information is available on the roadway portion of this project only.

COOPERATION BETWEEN CONTRACTORS:

(7-1-95)

105-7

SP1 G133

The Contractor's attention is directed to Article 105-7 of the *2018 Standard Specifications*.

U-4751 – NCDOT Contract C203980 Project Limits in Relation to DC00277: SR 1409 (Military Cutoff Rd. Ext.) from SR 1409 to US 17 in Wilmington.

The Contractor on this project shall cooperate with the Contractor working within or adjacent to the limits of this project to the extent that the work can be carried out to the best advantage of all concerned.

ELECTRONIC BIDDING:

(2-19-19)

101, 102, 103

SP1 G140

Revise the *2018 Standard Specifications* as follows:

Page 1-4, Article 101-3, DEFINITIONS, BID (OR PROPOSAL) *Electronic Bid*, line 1, replace “Bid Express®” with “the approved electronic bidding provider”.

Page 1-15, Subarticle 102-8(B), *Electronic Bids*, lines 39-40, replace “to Bid Express®” with “via the approved electronic bidding provider”.

Page 1-15, Subarticle 102-8(B)(1), *Electronic Bids*, line 41, delete “from Bid Express®”

Page 1-17, Subarticle 102-9(C)(2), *Electronic Bids*, line 21, replace “Bid Express® miscellaneous folder within the .ebs” with “electronic submittal”.

Page 1-29, Subarticle 103-4(C)(2), *Electronic Bids*, line 32, replace “.ebs miscellaneous data file of Expedite” with “electronic submittal file”

TWELVE MONTH GUARANTEE:

(7-15-03)

108

SP1 G145

- (A) The Contractor shall guarantee materials and workmanship against latent and patent defects arising from faulty materials, faulty workmanship or negligence for a period of twelve months following the date of final acceptance of the work for maintenance and shall replace such defective materials and workmanship without cost to the Department. The Contractor will not be responsible for damage due to faulty design, normal wear and tear, for negligence on the part of the Department, and/or for use in excess of the design.
- (B) Where items of equipment or material carry a manufacturer’s guarantee for any period in excess of twelve months, then the manufacturer’s guarantee shall apply for that particular piece of equipment or material. The Department’s first remedy shall be through the manufacturer although the Contractor is responsible for invoking the warranted repair work with the manufacturer. The Contractor’s responsibility shall be limited to the term of the manufacturer’s guarantee. NCDOT would be afforded the same warranty as provided by the Manufacturer.

This guarantee provision shall be invoked only for major components of work in which the Contractor would be wholly responsible for under the terms of the contract. Examples would include pavement structures, bridge components, and sign structures. This provision will not be used as a mechanism to force the Contractor to return to the project to make repairs or perform additional work that the Department would normally compensate the Contractor for. In addition, routine maintenance activities (i.e. mowing grass, debris removal, ruts in earth shoulders,) are not parts of this guarantee.

Appropriate provisions of the payment and/or performance bonds shall cover this guarantee for the project.

To ensure uniform application statewide the Division Engineer will forward details regarding the circumstances surrounding any proposed guarantee repairs to the Chief Engineer for review and approval prior to the work being performed.

EROSION AND SEDIMENT CONTROL/STORMWATER CERTIFICATION:

(1-16-07) (Rev 04-01-19)

105-16, 225-2, 16

SP1 G180

General

Schedule and conduct construction activities in a manner that will minimize soil erosion and the resulting sedimentation and turbidity of surface waters. Comply with the requirements herein regardless of whether or not a National Pollution discharge Elimination System (NPDES) permit for the work is required.

Establish a chain of responsibility for operations and subcontractors' operations to ensure that the *Erosion and Sediment Control/Stormwater Pollution Prevention Plan* is implemented and maintained over the life of the contract.

- (A) *Certified Supervisor* - Provide a certified Erosion and Sediment Control/Stormwater Supervisor to manage the Contractor and subcontractor operations, insure compliance with Federal, State and Local ordinances and regulations, and manage the Quality Control Program.
- (B) *Certified Foreman* - Provide a certified, trained foreman for each construction operation that increases the potential for soil erosion or the possible sedimentation and turbidity of surface waters.
- (C) *Certified Installer* - Provide a certified installer to install or direct the installation for erosion or sediment/stormwater control practices.
- (D) *Certified Designer* - Provide a certified designer for the design of the erosion and sediment control/stormwater component of reclamation plans and, if applicable, for the design of the project erosion and sediment control/stormwater plan.

Roles and Responsibilities

- (A) *Certified Erosion and Sediment Control/Stormwater Supervisor* - The Certified Supervisor shall be Level II and responsible for ensuring the erosion and sediment control/stormwater plan is adequately implemented and maintained on the project and for conducting the quality control program. The Certified Supervisor shall be on the project within 24 hours notice from initial exposure of an erodible surface to the project's final acceptance. Perform the following duties:
 - (1) *Manage Operations* - Coordinate and schedule the work of subcontractors so that erosion and sediment control/stormwater measures are fully executed for each operation and in a timely manner over the duration of the contract.
 - (a) Oversee the work of subcontractors so that appropriate erosion and sediment control/stormwater preventive measures are conformed to at each stage of the work.
 - (b) Prepare the required National Pollutant Discharge Elimination System (NPDES) Inspection Record and submit to the Engineer.
 - (c) Attend all weekly or monthly construction meetings to discuss the findings of the NPDES inspection and other related issues.
 - (d) Implement the erosion and sediment control/stormwater site plans requested.
 - (e) Provide any needed erosion and sediment control/stormwater practices for the Contractor's temporary work not shown on the plans, such as, but not limited to work platforms, temporary construction, pumping operations, plant and storage yards, and cofferdams.

- (f) Acquire applicable permits and comply with requirements for borrow pits, dewatering, and any temporary work conducted by the Contractor in jurisdictional areas.
 - (g) Conduct all erosion and sediment control/stormwater work in a timely and workmanlike manner.
 - (h) Fully perform and install erosion and sediment control/stormwater work prior to any suspension of the work.
 - (i) Coordinate with Department, Federal, State and Local Regulatory agencies on resolution of erosion and sediment control/stormwater issues due to the Contractor's operations.
 - (j) Ensure that proper cleanup occurs from vehicle tracking on paved surfaces or any location where sediment leaves the Right-of-Way.
 - (k) Have available a set of erosion and sediment control/stormwater plans that are initialed and include the installation date of Best Management Practices. These practices shall include temporary and permanent groundcover and be properly updated to reflect necessary plan and field changes for use and review by Department personnel as well as regulatory agencies.
- (2) Requirements set forth under the NPDES Permit - The Department's NPDES Stormwater permit (NCS000250) outlines certain objectives and management measures pertaining to construction activities. The permit references *NCG010000, General Permit to Discharge Stormwater* under the NPDES, and states that the Department shall incorporate the applicable requirements into its delegated Erosion and Sediment Control Program for construction activities disturbing one or more acres of land. The Department further incorporates these requirements on all contracted bridge and culvert work at jurisdictional waters, regardless of size. Some of the requirements are, but are not limited to:
- (a) Control project site waste to prevent contamination of surface or ground waters of the state, i.e. from equipment operation/maintenance, construction materials, concrete washout, chemicals, litter, fuels, lubricants, coolants, hydraulic fluids, any other petroleum products, and sanitary waste.
 - (b) Inspect erosion and sediment control/stormwater devices and stormwater discharge outfalls at least once every 7 calendar days and within 24 hours after a rainfall event of greater than 1.0 inch that occurs within a 24 hour period. Additional monitoring may be required at the discretion of Division of Water Resources personnel if the receiving stream is 303(d) listed for turbidity and the project has had documented problems managing turbidity.
 - (c) Maintain an onsite rain gauge or use the Department's Multi-Sensor Precipitation Estimate website to maintain a daily record of rainfall amounts and dates.
 - (d) Maintain erosion and sediment control/stormwater inspection records for review by Department and Regulatory personnel upon request.
 - (e) Implement approved reclamation plans on all borrow pits, waste sites and staging areas.
 - (f) Maintain a log of turbidity test results as outlined in the Department's Procedure for Monitoring Borrow Pit Discharge.
 - (g) Provide secondary containment for bulk storage of liquid materials.
 - (h) Provide training for employees concerning general erosion and sediment control/stormwater awareness, the Department's NPDES Stormwater Permit NCS000250 requirements, and the applicable requirements of the *General Permit, NCG010000*.

- (i) Report violations of the NPDES permit to the Engineer immediately who will notify the Division of Water Quality Regional Office within 24 hours of becoming aware of the violation.
- (3) Quality Control Program - Maintain a quality control program to control erosion, prevent sedimentation and follow provisions/conditions of permits. The quality control program shall:
- (a) Follow permit requirements related to the Contractor and subcontractors' construction activities.
 - (b) Ensure that all operators and subcontractors on site have the proper erosion and sediment control/stormwater certification.
 - (c) Notify the Engineer when the required certified erosion and sediment control/stormwater personnel are not available on the job site when needed.
 - (d) Conduct the inspections required by the NPDES permit.
 - (e) Take corrective actions in the proper timeframe as required by the NPDES permit for problem areas identified during the NPDES inspections.
 - (f) Incorporate erosion control into the work in a timely manner and stabilize disturbed areas with mulch/seed or vegetative cover on a section-by-section basis.
 - (g) Use flocculants approved by state regulatory authorities where appropriate and where required for turbidity and sedimentation reduction.
 - (h) Ensure proper installation and maintenance of temporary erosion and sediment control devices.
 - (i) Remove temporary erosion or sediment control devices when they are no longer necessary as agreed upon by the Engineer.
 - (j) The Contractor's quality control and inspection procedures shall be subject to review by the Engineer. Maintain NPDES inspection records and make records available at all times for verification by the Engineer.
- (B) *Certified Foreman* - At least one Certified Foreman shall be onsite for each type of work listed herein during the respective construction activities to control erosion, prevent sedimentation and follow permit provisions:
- (1) Foreman in charge of grading activities
 - (2) Foreman in charge of bridge or culvert construction over jurisdictional areas
 - (3) Foreman in charge of utility activities
- The Contractor may request to use the same person as the Level II Supervisor and Level II Foreman. This person shall be onsite whenever construction activities as described above are taking place. This request shall be approved by the Engineer prior to work beginning.
- The Contractor may request to name a single Level II Foreman to oversee multiple construction activities on small bridge or culvert replacement projects. This request shall be approved by the Engineer prior to work beginning.
- (C) *Certified Installers* - Provide at least one onsite, Level I Certified Installer for each of the following erosion and sediment control/stormwater crew:
- (1) Seeding and Mulching
 - (2) Temporary Seeding
 - (3) Temporary Mulching
 - (4) Sodding

- (5) Silt fence or other perimeter erosion/sediment control device installations
- (6) Erosion control blanket installation
- (7) Hydraulic tackifier installation
- (8) Turbidity curtain installation
- (9) Rock ditch check/sediment dam installation
- (10) Ditch liner/matting installation
- (11) Inlet protection
- (12) Riprap placement
- (13) Stormwater BMP installations (such as but not limited to level spreaders, retention/detention devices)
- (14) Pipe installations within jurisdictional areas

If a Level I *Certified Installer* is not onsite, the Contractor may substitute a Level II Foreman for a Level I Installer, provided the Level II Foreman is not tasked to another crew requiring Level II Foreman oversight.

- (D) *Certified Designer* - Include the certification number of the Level III-B Certified Designer on the erosion and sediment control/stormwater component of all reclamation plans and if applicable, the certification number of the Level III-A Certified Designer on the design of the project erosion and sediment control/stormwater plan.

Preconstruction Meeting

Furnish the names of the *Certified Erosion and Sediment Control/Stormwater Supervisor*, *Certified Foremen*, *Certified Installers* and *Certified Designer* and notify the Engineer of changes in certified personnel over the life of the contract within 2 days of change.

Ethical Responsibility

Any company performing work for the North Carolina Department of Transportation has the ethical responsibility to fully disclose any reprimand or dismissal of an employee resulting from improper testing or falsification of records.

Revocation or Suspension of Certification

Upon recommendation of the Chief Engineer to the certification entity, certification for *Supervisor*, *Certified Foremen*, *Certified Installers* and *Certified Designer* may be revoked or suspended with the issuance of an *Immediate Corrective Action (ICA)*, *Notice of Violation (NOV)*, or *Cease and Desist Order* for erosion and sediment control/stormwater related issues.

The Chief Engineer may recommend suspension or permanent revocation of certification due to the following:

- (A) Failure to adequately perform the duties as defined within this certification provision.
- (B) Issuance of an ICA, NOV, or Cease and Desist Order.
- (C) Failure to fully perform environmental commitments as detailed within the permit conditions and specifications.
- (D) Demonstration of erroneous documentation or reporting techniques.
- (E) Cheating or copying another candidate's work on an examination.
- (F) Intentional falsification of records.
- (G) Directing a subordinate under direct or indirect supervision to perform any of the above actions.

- (H) Dismissal from a company for any of the above reasons.
- (I) Suspension or revocation of one's certification by another entity.

Suspension or revocation of a certification will be sent by certified mail to the certificant and the Corporate Head of the company that employs the certificant.

A certificant has the right to appeal any adverse action which results in suspension or permanent revocation of certification by responding, in writing, to the Chief Engineer within 10 calendar days after receiving notice of the proposed adverse action.

Chief Engineer
1536 Mail Service Center
Raleigh, NC 27699-1536

Failure to appeal within 10 calendar days will result in the proposed adverse action becoming effective on the date specified on the certified notice. Failure to appeal within the time specified will result in a waiver of all future appeal rights regarding the adverse action taken. The certificant will not be allowed to perform duties associated with the certification during the appeal process.

The Chief Engineer will hear the appeal and make a decision within 7 days of hearing the appeal. Decision of the Chief Engineer will be final and will be made in writing to the certificant.

If a certification is temporarily suspended, the certificant shall pass any applicable written examination and any proficiency examination, at the conclusion of the specified suspension period, prior to having the certification reinstated.

Measurement and Payment

Certified Erosion and Sediment Control/Stormwater Supervisor, Certified Foremen, Certified Installers and Certified Designer will be incidental to the project for which no direct compensation will be made.

PROCEDURE FOR MONITORING BORROW PIT DISCHARGE:

(2-20-07) (Rev. 4-5-19)

105-16, 230, 801

SP1 G181

Water discharge from borrow pit sites shall not cause surface waters to exceed 50 NTUs (nephelometric turbidity unit) in streams not designated as trout waters and 10 NTUs in streams, lakes or reservoirs designated as trout waters. For lakes and reservoirs not designated as trout waters, the turbidity shall not exceed 25 NTUs. If the turbidity exceeds these levels due to natural background conditions, the existing turbidity level shall not be increased.

If during any operating day, the downstream water quality exceeds the standard, the Contractor shall do all of the following:

- (A) Either cease discharge or modify the discharge volume or turbidity levels to bring the downstream turbidity levels into compliance, or
- (B) Evaluate the upstream conditions to determine if the exceedance of the standard is due to natural background conditions. If the background turbidity measurements exceed the standard, operation of the pit and discharge can continue as long as the stream turbidity levels are not increased due to the discharge.

- (C) Measure and record the turbidity test results (time, date and sampler) at all defined sampling locations 30 minutes after startup and at a minimum, one additional sampling of all sampling locations during that 24-hour period in which the borrow pit is discharging.
- (D) Notify DWQ within 24 hours of any stream turbidity standard exceedances that are not brought into compliance.

During the Environmental Assessment required by Article 230-4 of the *2018 Standard Specifications*, the Contractor shall define the point at which the discharge enters into the State's surface waters and the appropriate sampling locations. Sampling locations shall include points upstream and downstream from the point at which the discharge enters these waters. Upstream sampling location shall be located so that it is not influenced by backwater conditions and represents natural background conditions. Downstream sampling location shall be located at the point where complete mixing of the discharge and receiving water has occurred.

The discharge shall be closely monitored when water from the dewatering activities is introduced into jurisdictional wetlands. Any time visible sedimentation (deposition of sediment) on the wetland surface is observed, the dewatering activity will be suspended until turbidity levels in the stilling basin can be reduced to a level where sediment deposition does not occur. Staining of wetland surfaces from suspended clay particles, occurring after evaporation or infiltration, does not constitute sedimentation. No activities shall occur in wetlands that adversely affect the functioning of a wetland. Visible sedimentation will be considered an indication of possible adverse impacts on wetland use.

The Engineer will perform independent turbidity tests on a random basis. These results will be maintained in a log within the project records. Records will include, at a minimum, turbidity test results, time, date and name of sampler. Should the Department's test results exceed those of the Contractor's test results, an immediate test shall be performed jointly with the results superseding the previous test results of both the Department and the Contractor.

The Contractor shall use the *NCDOT Turbidity Reduction Options for Borrow Pits Matrix*, available at <https://connect.ncdot.gov/resources/roadside/FieldOperationsDocuments/TurbidityReductionOptionSheet.pdf> to plan, design, construct, and maintain BMPs to address water quality standards. Tier I Methods include stilling basins which are standard compensatory BMPs. Other Tier I methods are noncompensatory and shall be used when needed to meet the stream turbidity standards. Tier II Methods are also noncompensatory and are options that may be needed for protection of rare or unique resources or where special environmental conditions exist at the site which have led to additional requirements being placed in the DWQ's 401 Certifications and approval letters, Isolated Wetland Permits, Riparian Buffer Authorization or a DOT Reclamation Plan's Environmental Assessment for the specific site. Should the Contractor exhaust all Tier I Methods on a site exclusive of rare or unique resources or special environmental conditions, Tier II Methods may be required by regulators on a case by case basis per supplemental agreement.

The Contractor may use cation exchange capacity (CEC) values from proposed site borings to plan and develop the bid for the project. CEC values exceeding 15 milliequivalents per 100 grams of soil may indicate a high potential for turbidity and should be avoided when dewatering into surface water is proposed.

No additional compensation for monitoring borrow pit discharge will be paid.

PROJECT SPECIAL PROVISIONS

ROADWAY

NOTES TO CONTRACTOR:

- All metal traffic signal utility poles and related hardware removed from the project limits shall be delivered by the contractor to the NCDOT Division 3 Traffic Services Maintenance Yard located at 5504 Barbados Blvd. Castle Hayne, NC 28429. Please notify Mr. Ross Kimbro with NCDOT Division 3 Traffic Services at 910-341-2200 a minimum of 48 hours prior to transporting the metal poles. No compensation will be made for the delivery of the metal poles and shall be considered incidental to other contract line items.
- All construction lighting for nighttime work on -Y1- (US 17 Military Cutoff Rd.) and -Y4- (US 74 Eastwood Rd.) will be incidental to other contract items.

CONSTRUCTION SEQUENCE:

(7-1-95) (Rev. 8-21-12)

560

SP1 R34R

Pave each section of roadway begun in a continuous operation. Do not begin work on another section of roadway unless satisfactory progress is being made toward completion of intersections and all other required incidental work by satisfactorily furnishing additional paving equipment and personnel, except for milling and patching operations.

BURNING RESTRICTIONS:

(7-1-95)

200, 210, 215

SP2 R05

Open burning is not permitted on any portion of the right-of-way limits established for this project. Do not burn the clearing, grubbing or demolition debris designated for disposal and generated from the project at locations within the project limits, off the project limits or at any waste or borrow sites in this county. Dispose of the clearing, grubbing and demolition debris by means other than burning, according to state or local rules and regulations.

BORROW EXCAVATION (In Place or Truck Measurement):

(7-1-95)

230

SP2 R58

The borrow material used on this project will be measured for payment by in place measurement as provided in Article 230-5 of the *2018 Standard Specifications*, or by truck measurement as provided in Article 230-5 of the *2018 Standard Specifications*, as directed by the Engineer.

MANUFACTURED QUARRY FINES IN EMBANKMENTS:

(01-17-17)

235

SP02 R72

Description

This specification addresses the use of manufactured quarry fines that are not classified as select materials. The specification allows the Contractor an option, with the approval of the Engineer, to use manufactured quarry fines (MQFs) in embankments as a substitute for conventional borrow material. Furnish and place geotextile for pavement stabilization in accordance with the Geotextile for Pavement Stabilization special provision and detail. Geotextile for pavement stabilization is required to prevent pavement cracking and provide separation between the subgrade and pavement section at embankment locations where

manufactured quarry fines are utilized and as directed by the Engineer.

Materials

Manufactured Quarry Fines.

Site specific approval of MQFs material will be required prior to beginning construction as detailed in the preconstruction requirements of this provision.

The following MQFs are unacceptable:

- (A) Frozen material,
- (B) Material with a maximum dry unit weight of less than 90 pounds per cubic foot when tested in accordance with AASHTO T-99 Method A or C.
- (C) Material with greater than 80% by weight Passing the #200 sieve

Collect and transport MQFs in a manner that will prevent nuisances and hazards to public health and safety. Moisture condition the MQFs as needed and transport in covered trucks to prevent dusting. If MQFs are blended with natural earth material, follow Borrow Criteria in Section 1018 of the *Standard Specifications*.

Geotextiles

Areas of embankment where MQFs are incorporated, Geotextile for Pavement Stabilization shall be used. If the Geotextile for Pavement Stabilization special provision is not included elsewhere in this contract, then it along with a detail will be incorporated as part of the contractors request to use. Notification of subgrade elevation, sampling and waiting period as required in the Construction Methods section of the Geotextile for Pavement Stabilization special provision are not required.

Preconstruction Requirements

When MQFs are to be used as a substitute for earth borrow material, request written approval from the Engineer at least ninety (90) days in advance of the intent to use MQFs and include the following details:

- (A) Description, purpose and location of project.
- (B) Estimated start and completion dates of project.
- (C) Estimated volume of MQFs to be used on project with specific locations and construction details of the placement.
- (D) The names, address, and contact information for the generator of the MQFs.
- (E) Physical location of the site at which the MQFs were generated.

The Engineer will forward this information to the State Materials Engineer for review and material approval.

Construction Methods

Place MQFs in the core of the embankment section with at least 4 feet of earth cover to the outside limits of the embankments or subgrade.

Construct embankments by placing MQFs in level uniform lifts with no more than a lift of 10 inches and compacted to at least a density of 95 percent as determined by test methods in AASHTO T-99, Determination of Maximum Dry Density and Optimum Moisture Content, Method A or C depending upon particle size of the product. Provide a moisture content at the time of compaction of within 4 percent of optimum but not greater than one percent above optimum as determined by AASHTO T-99, Method A or C.

Areas of embankment where MQFs are incorporated, Geotextile for Pavement Stabilization shall be used.

See Geotextile for Pavement Stabilization special provision for geotextile type and construction method.

Measurement and Payment

Borrow Excavation will be measured by truck volume and paid in cubic yards in accordance with Article 230-5 of the *2018 Standard Specifications*. As an alternate weigh tickets can be provided and payment made by converting weight to cubic yards based on the verifiable unit weight.

Where the pay item of *Geotextile for Pavement Stabilization* is included in the original contract the material will be measured and paid in square yards (see Geotextile for Pavement Stabilization special provision). Where the pay item of *Geotextile for Pavement Stabilization* is not included in the original contract then no payment will be made for this item and will be considered incidental to the use of MQFs in embankment.

SHOULDER CLEANUP:

Description

Shoulder cleanup is the removal of earth material and vegetative growth along the existing roadway pavement edge. Remove earth material and vegetation to provide a uniform pavement edge and shoulder slope in accordance with Standard Drawing No. 560.01 and 560.02 of the *2018 Roadway Standard Drawings*.

Measurement and Payment

Shoulder Cleanup will be measured and paid as the actual number of linear feet that have been cleaned up. Measurement will be made along the surface of each shoulder and to the nearest foot. Such price and payment will be full compensation for removal of earth material, hauling and grading of the shoulder slope.

Seeding and Mulching will be measured and paid as provided elsewhere in this contract.

Payment will be made under:

Pay Item
Shoulder Cleanup

Pay Unit
Linear Foot



12/5/2019

STORMWATER POND GRADING:

Description

Excavate and satisfactorily dispose of all materials excavated for the construction of the proposed stormwater pond. Complete all final grading required to complete installation and begin operation of the proposed stormwater pond. The work covered in this special provision consists of elements of work covered by Sections 225, 226, 240 and 500.

General

Excavate and complete final grading to the lines, grades, and details as shown in the plans. Coordinate all work covered by this section with the grading, construction of drainage structures, walls, drawdown structure, excavation of borrow and material sources. Maintain in a satisfactory condition so that adequate drainage is provided at all times.

In accordance with the plans, fill embankment material shall consist of A-4, A-5, or A-6 soils and be compacted to 95% of AASHTO T-99 (Standard Proctor). All disturbed basin slopes draining into the filtration basin shall be sodded with Bermuda sod.

Maintain the pond grading until the final acceptance of the project. Trim flush with the slopes any roots that protrude into the pond area. Maintain operation of existing stormwater pond throughout the project as directed by the Engineer.

Disposal of Materials

Use excavated materials in the construction of proposed roadway or pond embankment only as approved by the Engineer. Deposit materials that are in excess to the needs of the project alongside the pond and spread to form an inconspicuous soil bank of sufficient regular contour to permit seeding and mowing, provided no drainage is blocked.

At the direction of the Engineer, abandon existing pond operation only after the proposed pond is completed and approved to begin functioning.

Measurement and Payment

Stormwater Pond Grading will be measured and paid as the actual number of cubic yards excavated for the construction of the proposed stormwater pond, or as directed. Work includes, but is not limited to, excavation, shaping of the proposed pond, material disposal, construction of earth berms, maintenance of the work in an acceptable condition until final acceptance, and abandonment of the existing stormwater pond.

No measurement and payment will be made where excavation has been performed beyond the above limits; made solely for the convenience of the Contractor; for temporary drainage of the project; or for any excavation to provide drainage of borrow or material sources furnished by the Contractor.

Installation of other pond components, including the MSE wall and drawdown structure will be paid for separately. All other necessary construction will be incidental to this pay item.

Payment will be made under:

Pay Item

Generic Grading – Stormwater Pond Grading

Pay Unit

Cubic Yard



12/5/2019

DRAWDOWN STRUCTURE:

Description

Installation of drawdown structure components required for stormwater pond construction. The work covered in this special provision consists of elements of work covered by Section 300, 305, 310 and 840.

General

Install drawdown structure components to the elevations, dimensions, and details as shown in the plans. Coordinate all work covered by this section with the grading, walls, drainage system, and excavation and maintain in a satisfactory condition so that adequate drainage is provided at all times. Maintain all drainage structures until the final acceptance of the project.

Measurement and Payment

Drawdown Structure installation will be measured and paid for as lump sum. Work includes, but is not limited to the following items:

- Riser Trash Rack and associated hardware
- Tee Pipe
- 6” Drawdown Pipe and Shutoff Valve
- Masonry, Precast or Cast in Place Drainage Structure

Installation of other drainage elements, including reinforced concrete drainage pipes, will be paid for separately. All other necessary construction will be incidental to this pay item.

Payment will be made under:

Pay Item
Drawdown Structure

Pay Unit
Lump Sum



12/5/2019

BLACK VINYL COATED CHAIN LINK FENCE FABRIC:

Description

Provide black vinyl coated chain link fence in accordance with the plans and Article 1050-6 of the *Standard Specifications*.

Materials

Provide materials that meet the requirements of Article 866-2 of the *Standard Specifications*.

Construction Methods

Construct the black vinyl coated chain link fence in accordance with Article 866-3 of the *Standard Specifications*.

Measurement and Payment

Black Vinyl Coated Chain Link Fence, _” Fabric, Black Vinyl Coated Metal Terminal Post for _” Chain Link Fence, Black Vinyl Coated Metal Line Post for _” Chain Link Fence, Black Vinyl Coated Metal Gate Posts for _” Chain Link Fence, Single Gate and Black Vinyl Coated Single Gates, _” High, _’ Wide, _’ Opening will be measured and paid for in accordance with Article 866-4 of the Standard Specifications.

Payment will be made under:

Pay Item	Pay Unit
Black Vinyl Coated Chain Link Fence, 48” Fabric	Linear Foot
Black Vinyl Coated Metal Terminal Post for 48” Chain Link Fence	Each
Black Vinyl Coated Metal Line Post for 48” Chain Link Fence	Each
Black Vinyl Coated Metal Gate Posts for 48” Chain Link Fence, Single Gate	Each
Black Vinyl Coated Single Gates, 48” High, 10’ Wide, 10’ Opening	Each



12/5/2019

OYSTER SHELL SPECIAL VALLEY GUTTER:

Description

Construct Oyster Shell Special Valley Gutter in accordance with the plans

Materials

Provide materials that match the existing curbing within the Eastport Subdivision limits, and that meet the requirements of Article 846-2 of the *Standard Specifications*.

Construction Methods

Construct the Oyster Shell Special Valley Gutter in accordance with Article 846-3 of the *Standard Specifications*.

Measurement and Payment

Oyster Shell Special Valley Gutter will be measured and paid for in linear feet, accepted in place. Measurement will be made along the surface of the top of the curb.

Payment will be made under:

Pay Item

Oyster Shell Special Valley Gutter

Pay Unit

Linear Foot



12/5/2019

OYSTER SHELL 6” CONCRETE DRIVEWAY:

Description

Construct Oyster Shell 6” Concrete Driveway in accordance with the plans

Materials

Provide materials that match the existing concrete driveways within the Eastport Subdivision limits, and that meet the requirements of Article 848-2 of the *Standard Specifications*.

Construction Methods

Construct the Oyster Shell 6” Concrete Driveway in accordance with Article 848-3 of the *Standard Specifications*.

Measurement and Payment

Oyster Shell 6” Concrete Driveway will be measured and paid in square yards, measured along the surface of the completed and accepted work. Such price includes, but is not limited to, excavating and backfilling, sawing the existing driveway, furnishing and placing concrete, and constructing and sealing joints.

Payment will be made under:

Pay Item

Oyster Shell 6” Concrete Driveway

Pay Unit

Square Yard



12/5/2019

POLYPROPYLENE CULVERT PIPE:

(8-20-19)

305,310

SP3 R35

Revise the *2018 Standard Specifications* as follows:

Page 3-5, Article 305-1 DESCRIPTION, lines 12-14, replace with the following:

Where shown in the plans, the Contractor may use reinforced concrete pipe, aluminum alloy pipe, aluminized corrugated steel pipe, HDPE pipe, Polypropylene Pipe, or PVC pipe in accordance with the following requirements.

Page 3-5, Article 305-2 MATERIALS, add the following after line 16:

Item	Section
Polypropylene Pipe	1032-9

Page 3-6, Article 310-2 MATERIALS, add the following after line 9:

Item	Section
Polypropylene Pipe	1032-9

Page 3-6, Article 310-4 SIDE DRAIN PIPE, lines 24-25, replace the first sentence of the second paragraph with the following:

Where shown in the plans, side drain pipe may be Class II reinforced concrete pipe, aluminized corrugated steel pipe, corrugated aluminum alloy pipe, polypropylene pipe, HDPE pipe or PVC pipe.

Page 3-7, Article 310-5 PIPE END SECTIONS, lines 2-4, replace the second sentence with the following:

Both corrugated steel and concrete pipe end sections will work on concrete pipe, corrugated steel pipe, polypropylene pipe, and HDPE smooth lined corrugated plastic pipe.

Page 3-7, Article 310-6 MEASUREMENT AND PAYMENT, add the following after line 14:

Pay Item	Pay Unit
___" Polypropylene Pipe	Linear Foot

Page 10-60, add Article 1032-9:

(A) General

Use polypropylene pipe from sources participating in the Department's Polypropylene Pipe QA/QC Program. A list of participating sources is available from the Materials and Tests Unit. The Department will remove a manufacturer of polypropylene pipe from this program if the monitoring efforts indicated that non-specification material is being provided or test procedures are not being followed.

Use polypropylene culvert pipe that meets AASHTO M 330 for Type S or Type D, or ASTM F2881 or ASTM F2764 Double or Triple wall; and has been evaluated by NTPEP.

(B) End Treatments, Pipe Tees and Elbows

End treatments, pipe tees and elbows shall meet AASHTO M 330, Section 7.7, or ASTM F2764,

Section 6.6.

(C) Marking

Clearly mark each section of pipe, end section, tee and elbow and other accessories according to the Department's Polypropylene Pipe QC/QA Program:

- (1) AASHTO or ASTM Designation
- (2) The date of manufacture
- (3) Name or trademark of the manufacturer

When polypropylene pipe, end sections, tees and elbows have been inspected and accepted a sticker will be applied to the inside of the pipe. Do not use pipe sections, flared end sections, tees or elbows which do not have this seal of approval.

AUTOMATED FINE GRADING:

(1-16-96)

610

SP5 R05

On mainline portions and ramps of this project, prepare the subgrade and base beneath the pavement structure in accordance with the applicable sections of the *2018 Standard Specifications* except use an automatically controlled fine grading machine using string lines, laser controls or other approved methods to produce final subgrade and base surfaces meeting the lines, grades and cross sections required by the plans or established by the Engineer.

No direct payment will be made for the work required by this provision as it will be considered incidental to other work being paid for by the various items in the contract.

AGGREGATE SUBGRADE:

(5-15-18)

505

SP5 R8

Revise the *2018 Standard Specifications* as follows:

Page 5-8, Article 505-1 DESCRIPTION, lines 4-6, replace the paragraph with the following:

Construct aggregate subgrades in accordance with the contract. Install geotextile for soil stabilization and place Class IV subgrade stabilization at locations shown in the plans and as directed.

Undercut natural soil materials if necessary to construct aggregate subgrades. Define "subbase" as the portion of the roadbed below the Class IV subgrade stabilization. For Type 2 aggregate subgrades, undercut subbases as needed. The types of aggregate subgrade with thickness and compaction requirements for each are as shown below.

Type 1 – A 6 to 24 inch thick aggregate subgrade with Class IV subgrade stabilization compacted to 92% of AASHTO T 180 as modified by the Department or to the highest density that can be reasonably obtained.

Type 2 – An 8 inch thick aggregate subgrade on a proof rolled subbase with Class IV subgrade stabilization compacted to 97% of AASHTO T 180 as modified by the Department.

Page 5-8, Article 505-3 CONSTRUCTION METHODS, line 12, insert the following after the first sentence of the first paragraph:

For Type 2 aggregate subgrades, proof roll subbases in accordance with Section 260 before installing geotextile for soil stabilization.

Page 5-8, Article 505-3 CONSTRUCTION METHODS, lines 16-17, replace the last sentence of the first paragraph with the following:

Compact ABC as required for the type of aggregate subgrade constructed.

Page 5-8, Article 505-4 MEASUREMENT AND PAYMENT, line 26, insert the following after the last sentence of the first paragraph:

Undercut Excavation of natural soil materials from subbases for Type 2 aggregate subgrades will be measured and paid in accordance with Article 225-7 or 226-3. No measurement will be made for any undercut excavation of fill materials from subbases.

STABILIZATION OF COASTAL PLAIN SANDS:

(11-18-14)

510

SP5 R12

Description

As directed by the Engineer, stabilize sandy subgrade material with Class IV aggregate to prevent rutting of the subgrade prior to paving directly on the subgrade. Remove material as needed in cut areas prior to placing the Class IV aggregate.

Materials

Refer to Division 10.

Item	Section
Select Material, Class IV	1016

Use Class IV Select Material for Class IV Aggregate Stabilization.

Construction Methods

Class IV Aggregate Stabilization

As directed by the Engineer, place aggregate by end dumping aggregate on approved subgrade soils to provide a working platform and reduce wheel rutting of subgrade material. Place the Class IV aggregate stabilization to a thickness of 2 to 3 inches.

Maintenance

Maintain aggregate stabilization in an acceptable condition and minimize the use of heavy equipment on aggregate in order to avoid damaging the subgrade. Provide and maintain drainage ditches and drains as required to prevent entrapping water in aggregate stabilization.

Measurement and Payment

Class IV Aggregate Stabilization will be measured and paid in tons. Aggregate will be measured by weighing in trucks in accordance with Article 106-7. The contract unit price for *Class IV Aggregate*

Stabilization will be full compensation for furnishing, hauling, handling, placing, mixing, compacting and maintaining aggregate.

The work to excavate material to place Class IV Aggregate Stabilization below subgrade is considered incidental to the work of placing the aggregate and no separate payment will be made.

Payment will be made under:

Pay Item	Pay Unit
Class IV Aggregate Stabilization	Ton

INCIDENTAL STONE BASE:

(7-1-95) (Rev. 8-21-12)

545

SP5 R28R

Description

Place incidental stone base on driveways, mailboxes, etc. immediately after paving and do not have the paving operations exceed stone base placement by more than one week without written permission of the Engineer.

Materials and Construction

Provide and place incidental stone base in accordance with Section 545 of the *2018 Standard Specifications*.

Measurement and Payment

Incidental Stone Base will be measured and paid in accordance with Article 545-6 of the *2018 Standard Specifications*.

PRICE ADJUSTMENT - ASPHALT BINDER FOR PLANT MIX:

(11-21-00)

620

SP6 R25

Price adjustments for asphalt binder for plant mix will be made in accordance with Section 620 of the *2018 Standard Specifications*.

The base price index for asphalt binder for plant mix is \$ **487.14** per ton.

This base price index represents an average of F.O.B. selling prices of asphalt binder at supplier's terminals on **December 1, 2019**.

FINAL SURFACE TESTING NOT REQUIRED:

(5-18-04) (Rev. 2-16-16)

610

SP6 R45

Final surface testing is not required on this project in accordance with Section 610-13, *Final Surface Testing and Acceptance*.

ASPHALT CONCRETE PLANT MIX PAVEMENTS:

(2-20-18) (Rev. 1-15-19)

610, 1012

SP6 R65

Revise the *2018 Standard Specifications* as follows:

Page 6-14, Table 609-3, LIMITS OF PRECISION FOR TEST RESULTS, replace with the following:

Mix Property	Limits of Precision
25.0 mm sieve (Base Mix)	± 10.0%
19.0 mm sieve (Base Mix)	± 10.0%
12.5 mm sieve (Intermediate & Type P-57)	± 6.0%
9.5 mm sieve (Surface Mix)	± 5.0%
4.75 mm sieve (Surface Mix)	± 5.0%
2.36 mm sieve (All Mixes, except S4.75A)	± 5.0%
1.18 mm sieve (S4.75A)	± 5.0%
0.075 mm sieve (All Mixes)	± 2.0%
Asphalt Binder Content	± 0.5%
Maximum Specific Gravity (G_{mm})	± 0.020
Bulk Specific Gravity (G_{mb})	± 0.030
TSR	± 15.0%
QA retest of prepared QC Gyratory Compacted Volumetric Specimens	± 0.015
Retest of QC Core Sample	± 1.2% (% Compaction)
Comparison QA Core Sample	± 2.0% (% Compaction)
QA Verification Core Sample	± 2.0% (% Compaction)
Density Gauge Comparison of QC Test	± 2.0% (% Compaction)
QA Density Gauge Verification Test	± 2.0% (% Compaction)

Page 6-17, Table 610-1, MIXING TEMPERATURE AT THE ASPHALT PLANT, replace with the following:

Binder Grade	JMF Temperature
PG 58-28; PG 64-22	250 - 290°F
PG 76-22	300 - 325°F

Page 6-17, Subarticle 610-3(C), Job Mix Formula (JMF), lines 38-39, delete the fourth paragraph.

Page 6-18, Subarticle 610-3(C), Job Mix Formula (JMF), line 12, replace “SF9.5A” with “S9.5B”.

Page 6-18, Table 610-3, MIX DESIGN CRITERIA, replace with the following:

Mix Type	Design ESALS millions ^A	Binder PG Grade	Compaction Levels		Max. Rut Depth (mm)	Volumetric Properties ^B			
			G_{mm} @			VMA % Min.	VTM %	VFA Min.-Max.	% G_{mm} @ N_{ini}
			N_{ini}	N_{des}					
S4.75A	< 1	64 - 22	6	50	11.5	16.0	4.0 - 6.0	65 - 80	≤ 91.5
S9.5B	0 - 3	64 - 22	6	50	9.5	16.0	3.0 - 5.0	70 - 80	≤ 91.5
S9.5C	3 - 30	64 - 22	7	65	6.5	15.5	3.0 - 5.0	65 - 78	≤ 90.5
S9.5D	> 30	76 - 22	8	100	4.5	15.5	3.0 - 5.0	65 - 78	≤ 90.0
I19.0C	ALL	64 - 22	7	65	-	13.5	3.0 - 5.0	65 - 78	≤ 90.5
B25.0C	ALL	64 - 22	7	65	-	12.5	3.0 - 5.0	65 - 78	≤ 90.5
Design Parameter						Design Criteria			

All Mix Types	Dust to Binder Ratio ($P_{0.075} / P_{be}$)		0.6 - 1.4 ^C
	Tensile Strength Ratio (TSR) ^D		85% Min. ^E

- A. Based on 20 year design traffic.
- B. Volumetric Properties based on specimens compacted to N_{des} as modified by the Department.
- C. Dust to Binder Ratio ($P_{0.075} / P_{be}$) for Type S4.75A is 1.0 - 2.0.
- D. NCDOT-T-283 (No Freeze-Thaw cycle required).
- E. TSR for Type S4.75A & B25.0C mixes is 80% minimum.

Page 6-19, Table 610-5, BINDER GRADE REQUIREMENTS (BASED ON RBR%), replace with the following:

**TABLE 610-5
BINDER GRADE REQUIREMENTS (BASED ON RBR%)**

Mix Type	%RBR \leq 20%	21% \leq %RBR \leq 30%	%RBR \geq 30%
S4.75A, S9.5B, S9.5C, I19.0C, B25.0C	PG 64-22	PG 64-22 ^A	PG-58-28
S9.5D, OGFC	PG 76-22 ^B	n/a	n/a

- A. If the mix contains any amount of RAS, the virgin binder shall be PG 58-28.
- B. Maximum Recycled Binder Replacement (%RBR) is 18% for mixes using PG 76-22 binder.

Page 6-20, Table 610-6, PLACEMENT TEMPERATURES FOR ASPHALT, replace with the following:

TABLE 610-6 PLACEMENT TEMPERATURES FOR ASPHALT	
Asphalt Concrete Mix Type	Minimum Surface and Air Temperature
B25.0C	35°F
I19.0C	35°F
S4.75A, S9.5B, S9.5C	40°F ^A
S9.5D	50°F

- A. For the final layer of surface mixes containing recycled asphalt shingles (RAS), the minimum surface and air temperature shall be 50°F.

Page 6-21, Article 610-8, SPREADING AND FINISHING, lines 34-35, delete the second sentence and replace with the following:

Use an MTV for all surface mix regardless of binder grade on Interstate, US Routes, and NC Routes (primary routes) that have 4 or more lanes and median divided.

Page 6-21, Article 610-8, SPREADING AND FINISHING, lines 36-38, delete the fourth sentence and replace with the following:

Use MTV for all ramps, loops, Y-line that have 4 or more lanes and are median divided, full width acceleration lanes, full width deceleration lanes, and full width turn lanes that are greater than 1000 feet in length.

Page 6-23, Table 610-7, DENSITY REQUIREMENTS, replace with the following:

TABLE 610-7 DENSITY REQUIREMENTS	
Mix Type	Minimum % G_{mm} (Maximum Specific Gravity)

S4.75A	85.0 ^A
S9.5B	90.0
S9.5C, S9.5D, I19.0C, B25.0C	92.0

- A. Compaction to the above specified density will be required when the S4.75A mix is applied at a rate of 100 lbs/sy or higher.

Page 6-24, Article 610-13, FINAL SURFACE TESTING, lines 35-36, delete the second sentence and replace with the following:

Final surface testing is not required on ramps, loops and turn lanes.

Page 6-26, Subarticle 610-13(A)(1), Acceptance for New Construction, lines 29-30, delete the second sentence and replace with the following:

Areas excluded from testing by the profiler may be tested using a 10-foot straightedge in accordance with Article 610-12.

Page 6-27, Subarticle 610-13(B), Option 2- North Carolina Hearne Straightedge, lines 41-46, delete the eighth and ninth sentence of this paragraph and replace with the following:

Take profiles over the entire length of the final surface travel lane pavement exclusive of structures, approach slabs, paved shoulders, tapers, or other irregular shaped areas of pavement, unless otherwise approved by the Engineer. Test in accordance with this provision all mainline travel lanes, full width acceleration or deceleration lanes and collector lanes.

Page 6-28, Subarticle 610-13(B), Option 2- North Carolina Hearne Straightedge, lines 1-2, delete these two lines.

Page 6-32, Article 610-16 MEASUREMENT AND PAYMENT, replace with the following:

Pay Item	Pay Unit
Asphalt Concrete Base Course, Type B25.0C	Ton
Asphalt Concrete Intermediate Course, Type I19.0C	Ton
Asphalt Concrete Surface Course, Type S4.75A	Ton
Asphalt Concrete Surface Course, Type S9.5B	Ton
Asphalt Concrete Surface Course, Type S9.5C	Ton
Asphalt Concrete Surface Course, Type S9.5D	Ton

Page 10-30, Table 1012-1, AGGREGATE CONSENSUS PROPERTIES, replace with the following:

**TABLE 1012-1
AGGREGATE CONSENSUS PROPERTIES^A**

Mix Type	Coarse Aggregate Angularity^B	Fine Aggregate Angularity % Minimum	Sand Equivalent % Minimum	Flat and Elongated 5 : 1 Ratio % Maximum
<i>Test Method</i>	<i>ASTM D5821</i>	<i>AASHTO T 304</i>	<i>AASHTO T 176</i>	<i>ASTM D4791</i>
S4.75A; S9.5B	75 / -	40	40	-
S9.5C; I19.0C; B25.0C	95 / 90	45	45	10

S9.5D	100 / 100	45	50	10
OGFC	100 / 100	45	45	10
UBWC	100 / 85	45	45	10

A. Requirements apply to the design aggregate blend.

B. 95 / 90 denotes that 95% of the coarse aggregate has one fractured face and 90% has 2 or more fractured faces.

AUTOMATED MACHINE GUIDANCE

(1-2-11)

801

SP8 R01

General

This Special Provision contains requirements to be followed if the Contractor elects to use Global Positioning System (GPS) machine control grading and shall be used in conjunction with Section 801 of the *Standard Specifications*. The use of this technology is referenced as Automated Machine Guidance (AMG).

All equipment using AMG shall be able to generate end results that meet the *Standard Specifications*. Perform test sections for each type of work to be completed with AMG to demonstrate that the system has the capability to achieve acceptable results. If acceptable results cannot be achieved, conform to the requirements for conventional stakeout.

The Contractor shall be responsible for all errors resulting from the use of AMG and shall correct deficiencies to the satisfaction of the Engineer at no cost to the Department.

Submittals

If the Contractor elects to use AMG, a Digital Terrain Model (DTM) of the design surface and all intermediate surfaces shall be developed and submitted to the Engineer for review.

At least 90 days prior to beginning grading operations, the Contractor shall submit to the Engineer an AMG work plan to include, but not limited to, proposed equipment, control software manufacturer and version, types of work to be completed using AMG, project site calibration report, repetitive calibration methods for construction equipment and rover units to be used for the duration of the project, and local GPS base station to be used for broadcasting differential correction data to rover units (this may include the NC Network RTK). All surveys must be tied to existing project control as established by NCDOT.

Inspection

The Engineer will perform quality assurance checks of all work associated with AMG. If it is determined that work is not being performed in a manner that will assure accurate results, the Engineer may require corrective action at no cost to the Department.

The Contractor shall provide the Engineer with one GPS rover unit for use during the duration of the contract. The rover will be loaded with the same model that is used with the AMG and have the same capability as rover units used by the Contractor. The rover will be kept in the possession of the Engineer and will be returned to the Contractor upon completion of the contract. Any maintenance or repairs required

for the rover will be the responsibility of the Contractor. Formal training of at least 8 hours shall be provided to the Engineer by the Contractor on the use of the proposed AMG system.

Subgrade and Base Controls

If the Contractor elects to use AMG for fine grading and placement of base or other roadway materials, the GPS shall be supplemented with a laser or robotic total station. Include details of the proposed system in the AMG work plan. In addition, the following requirements apply for the use of AMG for subgrade and base construction.

Provide control points at intervals along the project not to exceed 1,000 feet. The horizontal position of these points shall be determined by static GPS sessions or by traverse connection from the original base line control points. The elevation of these control points shall be established using differential leveling from project benchmarks, forming closed loops where practical. A copy of all new control point information shall be provided to the Engineer prior to construction activities.

Provide control points and conventional survey grade stakes at 500 foot intervals and at critical points such as, but not limited to, PCs, PTs, superelevation transition points, and other critical points as requested by the Engineer.

Provide hubs at the top of the finished subgrade at all hinge points on the cross section at 500 foot intervals. These hubs shall be established using conventional survey methods for use by the Engineer to check the accuracy of construction.

Measurement and Payment

No direct payment will be made for work required to utilize this provision. All work will be considered incidental to various grading operations.

FOUNDATIONS AND ANCHOR ROD ASSEMBLIES FOR METAL POLES:

(1-17-12) (Rev. 1-16-18)

9, 14, 17

SP9 R05

Description

Foundations for metal poles include foundations for signals, cameras, overhead and dynamic message signs (DMS) and high mount and light standards supported by metal poles or upright trusses. Foundations consist of footings with pedestals and drilled piers with or without grade beams or wings. Anchor rod assemblies consist of anchor rods (also called anchor bolts) with nuts and washers on the exposed ends of rods and nuts and a plate or washers on the other ends of rods embedded in the foundation.

Construct concrete foundations with the required resistances and dimensions and install anchor rod assemblies in accordance with the contract and accepted submittals. Construct drilled piers consisting of cast-in-place reinforced concrete cylindrical sections in excavated holes. Provide temporary casings or polymer slurry as needed to stabilize drilled pier excavations. Use a prequalified Drilled Pier Contractor to construct drilled piers for metal poles. Define "excavation" and "hole" as a drilled pier excavation and "pier" as a drilled pier.

This provision does not apply to foundations for signal pedestals; see Section 1743 of the *2018 Standard Specifications* and 2018 Roadway Standard Drawing No. 1743.01.

Materials

Refer to the *2018 Standard Specifications*.

Item	Section
Conduit	1091-3
Grout, Type 2	1003
Polymer Slurry	411-2(B)(2)
Portland Cement Concrete	1000
Reinforcing Steel	1070
Rollers and Chairs	411-2(C)
Temporary Casings	411-2(A)

Provide Type 3 material certifications in accordance with Article 106-3 of the *2018 Standard Specifications* for conduit, rollers, chairs and anchor rod assemblies. Store steel materials on blocking at least 12" above the ground and protect it at all times from damage; and when placing in the work make sure it is free from dirt, dust, loose mill scale, loose rust, paint, oil or other foreign materials. Load, transport, unload and store foundation and anchor rod assembly materials so materials are kept clean and free of damage. Bent, damaged or defective materials will be rejected.

Use conduit type in accordance with the contract. Use Class A concrete for footings and pedestals, Class Drilled Pier concrete for drilled piers and Class AA concrete for grade beams and wings including portions of drilled piers above bottom of wings elevations. Corrugated temporary casings may be accepted at the discretion of the Engineer. A list of approved polymer slurry products is available from:

connect.ncdot.gov/resources/Geological/Pages/Products.aspx

Provide anchor rod assemblies in accordance with the contract consisting of the following:

- (A) Straight anchor rods,
- (B) Heavy hex top and leveling nuts and flat washers on exposed ends of rods, and
- (C) Nuts and either flat plates or washers on the other ends of anchor rods embedded in foundations.

Do not use lock washers. Use steel anchor rods, nuts and washers that meet ASTM F1554 for Grade 55 rods and Grade A nuts. Use steel plates and washers embedded in concrete with a thickness of at least 1/4". Galvanize anchor rods and exposed nuts and washers in accordance with Article 1076-4 of the *2018 Standard Specifications*. It is not necessary to galvanize nuts, plates and washers embedded in concrete.

Construction Methods

Install the required size and number of conduits in foundations in accordance with the plans and accepted submittals. Construct top of piers, footings, pedestals, grade beams and wings flat, level and within 1" of elevations shown in the plans or approved by the Engineer. Provide an Ordinary Surface finish in accordance with Subarticle 825-6(B) of the *2018 Standard Specifications* for portions of foundations exposed above finished grade. Do not remove anchor bolt templates or pedestal or grade beam forms or erect metal poles or upright trusses onto foundations until concrete attains a compressive strength of at least 3,000 psi.

- (A) Drilled Piers

Before starting drilled pier construction, hold a predrill meeting to discuss the installation, monitoring and inspection of the drilled piers. Schedule this meeting after the Drilled Pier Contractor has mobilized to the site. The Resident or Division Traffic Engineer, Contractor and Drilled Pier Contractor Superintendent will attend this predrill meeting.

Do not excavate holes, install piles or allow equipment wheel loads or vibrations within 20 ft of completed piers until 16 hours after Drilled Pier concrete reaches initial set.

Check for correct drilled pier alignment and location before beginning drilling. Check plumbness of holes frequently during drilling.

Construct drilled piers with the minimum required diameters shown in the plans. Install piers with tip elevations no higher than shown in the plans or approved by the Engineer.

Excavate holes with equipment of the sizes required to construct drilled piers. Depending on the subsurface conditions encountered, drilling through rock and boulders may be required. Do not use blasting for drilled pier excavations.

Contain and dispose of drilling spoils and waste concrete as directed and in accordance with Section 802 of the *2018 Standard Specifications*. Drilling spoils consist of all materials and fluids removed from excavations.

If unstable, caving or sloughing materials are anticipated or encountered, stabilize holes with temporary casings and/or polymer slurry. Do not use telescoping temporary casings. If it becomes necessary to replace a temporary casing during drilling, backfill the excavation, insert a larger casing around the casing to be replaced or stabilize the excavation with polymer slurry before removing the temporary casing.

If temporary casings become stuck or the Contractor proposes leaving casings in place, temporary casings should be installed against undisturbed material. Unless otherwise approved, do not leave temporary casings in place for mast arm poles and cantilever signs. The Engineer will determine if casings may remain in place. If the Contractor proposes leaving temporary casings in place, do not begin drilling until a casing installation method is approved.

Use polymer slurry and additives to stabilize holes in accordance with the slurry manufacturer's recommendations. Provide mixing water and equipment suitable for polymer slurry. Maintain the required slurry properties at all times except for sand content.

Define a "sample set" as slurry samples collected from mid-height and within 2 ft of the bottom of holes. Take sample sets from excavations to test polymer slurry immediately after filling holes with slurry, at least every 4 hours thereafter and immediately before placing concrete. Do not place Drilled Pier concrete until both slurry samples from an excavation meet the required polymer slurry properties. If any slurry test results do not meet the requirements, the Engineer may suspend drilling until both samples from a sample set meet the required polymer slurry properties.

Remove soft and loose material from bottom of holes using augers to the satisfaction of the Engineer. Assemble rebar cages and place cages and Drilled Pier concrete in accordance with Subarticle 411-4(E) of the *2018 Standard Specifications* except for the following:

- (1) Inspections for tip resistance and bottom cleanliness are not required,
- (2) Temporary casings may remain in place if approved, and
- (3) Concrete placement may be paused near the top of pier elevations for anchor rod assembly installation and conduit placement or
- (4) If applicable, concrete placement may be stopped at bottom of grade beam or wings elevations for grade beam or wing construction.

If wet placement of concrete is anticipated or encountered, do not place Drilled Pier concrete until a concrete placement procedure is approved. If applicable, temporary casings and fluids may be removed when concrete placement is paused or stopped in accordance with the exceptions above provided holes are stable. Remove contaminated concrete from exposed Drilled Pier concrete after removing casings and fluids. If holes are unstable, do not remove temporary casings until a procedure for placing anchor rod assemblies and conduit or constructing grade beams or wings is approved.

Use collars to extend drilled piers above finished grade. Remove collars after Drilled Pier concrete sets and round top edges of piers.

If drilled piers are questionable, pile integrity testing (PIT) and further investigation may be required in accordance with Article 411-5 of the *2018 Standard Specifications*. A drilled pier will be considered defective in accordance with Subarticle 411-5(D) of the *2018 Standard Specifications* and drilled pier acceptance is based in part on the criteria in Article 411-6 of the *2018 Standard Specifications* except for the top of pier tolerances in Subarticle 411-6(C) of the *2018 Standard Specifications*.

If a drilled pier is under further investigation, do not grout core holes, backfill around the pier or perform any work on the drilled pier until the Engineer accepts the pier. If the drilled pier is accepted, dewater and grout core holes and backfill around the pier with approved material to finished grade. If the Engineer determines a pier is unacceptable, remediation is required in accordance with Article 411-6 of the *2018 Standard Specifications*. No extension of completion date or time will be allowed for remediation of unacceptable drilled piers or post repair testing.

Permanently embed a plate in or mark top of piers with the pier diameter and depth, size and number of vertical reinforcing bars and the minimum compressive strength of the concrete mix at 28 days.

(B) Footings, Pedestals, Grade Beams and Wings

Excavate as necessary for footings, grade beams and wings in accordance with the plans, accepted submittals and Section 410 of the *2018 Standard Specifications*. If unstable, caving or sloughing materials are anticipated or encountered, shore foundation excavations as needed with an approved method. Notify the Engineer when foundation excavation is complete. Do not place concrete or reinforcing steel until excavation dimensions and foundation material are approved.

Construct cast-in-place reinforced concrete footings, pedestals, grade beams and wings with the dimensions shown in the plans and in accordance with Section 825 of the *2018 Standard Specifications*. Use forms to construct portions of pedestals and grade beams protruding above finished grade. Provide a chamfer with a 3/4" horizontal width for pedestal and grade beam edges exposed above finished grade. Place concrete against undisturbed soil or backfill and fill in accordance with Article 410-8 of the *2018 Standard Specifications*. Proper compaction around footings and wings is critical for foundations to resist uplift and torsion forces.

(C) Anchor Rod Assemblies

Size anchor rods for design and the required projection above top of foundations. Determine required anchor rod projections from nut, washer and base plate thicknesses, the protrusion of 3 to 5 anchor rod threads above top nuts after tightening and the distance of one nut thickness between top of foundations and bottom of leveling nuts.

Protect anchor rod threads from damage during storage and installation of anchor rod assemblies. Before placing anchor rods in foundations, turn nuts onto and off rods past leveling nut locations. Turn nuts with the effort of one workman using an ordinary wrench without a cheater bar. Report any thread damage to the Engineer that requires extra effort to turn nuts.

Arrange anchor rods symmetrically about center of base plate locations as shown in the plans. Set anchor rod elevations based on required projections above top of foundations. Securely brace and hold rods in the correct position, orientation and alignment with a steel template. Do not weld to reinforcing steel, temporary casings or anchor rods.

Install top and leveling (bottom) nuts, washers and the base plate for each anchor rod assembly in accordance with the following procedure:

- (1) Turn leveling nuts onto anchor rods to a distance of one nut thickness between the top of foundation and bottom of leveling nuts. Place washers over anchor rods on top of leveling nuts.
- (2) Determine if nuts are level using a flat rigid template on top of washers. If necessary, lower leveling nuts to level the template in all directions or if applicable, lower nuts to tilt the template so the metal pole or upright truss will lean as shown in the plans. If leveling nuts and washers are not in full contact with the template, replace washers with galvanized beveled washers.
- (3) Verify the distance between the foundation and leveling nuts is no more than one nut thickness.
- (4) Place base plate with metal pole or upright truss over anchor rods on top of washers. High mount luminaires may be attached before erecting metal poles but do not attach cables, mast arms or trusses to metal poles or upright trusses at this time.
- (5) Place washers over anchor rods on top of base plate. Lubricate top nut bearing surfaces and exposed anchor rod threads above washers with beeswax, paraffin or other approved lubricant.
- (6) Turn top nuts onto anchor rods. If nuts are not in full contact with washers or washers are not in full contact with the base plate, replace washers with galvanized beveled washers.
- (7) Tighten top nuts to snug-tight with the full effort of one workman using a 12" wrench. Do not tighten any nut all at once. Turn top nuts in increments. Follow a star pattern cycling through each nut at least twice.
- (8) Repeat (7) for leveling nuts.
- (9) Replace washers above and below the base plate with galvanized beveled washers if the slope of any base plate face exceeds 1:20 (5%), any washer is not in firm contact with the base plate or any nut is not in firm contact with a washer. If any washers are replaced, repeat (7) and (8).

- (10) With top and leveling nuts snug-tight, mark each top nut on a corner at the intersection of 2 flats and a corresponding reference mark on the base plate. Mark top nuts and base plate with ink or paint that is not water-soluble. Use the turn-of-nut method for pretensioning. Do not pretension any nut all at once. Turn top nuts in increments for a total turn that meets the following nut rotation requirements:

NUT ROTATION REQUIREMENTS (Turn-of-Nut Pretensioning Method)	
Anchor Rod Diameter, inch	Requirement
$\leq 1 \frac{1}{2}$	1/3 turn (2 flats)
$> 1 \frac{1}{2}$	1/6 turn (1 flat)

Follow a star pattern cycling through each top nut at least twice.

- (11) Ensure nuts, washers and base plate are in firm contact with each other for each anchor rod. Cables, mast arms and trusses may now be attached to metal poles and upright trusses.
- (12) Between 4 and 14 days after pretensioning top nuts, use a torque wrench calibrated within the last 12 months to check nuts in the presence of the Engineer. Completely erect mast arm poles and cantilever signs and attach any hardware before checking top nuts for these structures. Check that top nuts meet the following torque requirements:

TORQUE REQUIREMENTS	
Anchor Rod Diameter, inch	Requirement, ft-lb
7/8	180
1	270
1 1/8	380
1 1/4	420
$\geq 1 \frac{1}{2}$	600

If necessary, retighten top nuts in the presence of the Engineer with a calibrated torque wrench to within ± 10 ft-lb of the required torque. Do not overtighten top nuts.

- (13) Do not grout under base plate.

Measurement and Payment

Foundations and anchor rod assemblies for metal poles and upright trusses will be measured and paid for elsewhere in the contract.

No payment will be made for temporary casings that remain in drilled pier excavations. No payment will be made for PIT. No payment will be made for further investigation of defective piers. Further investigation of piers that are not defective will be paid as extra work in accordance with Article 104-7 of the *2018 Standard Specifications*. No payment will be made for remediation of unacceptable drilled piers or post repair testing.

TC-1

WORK ZONE TRAFFIC CONTROL Project Special Provisions

Law Enforcement:

(05/14/2013)

Description

Furnish Law Enforcement Officers and marked Law Enforcement vehicles to direct traffic in accordance with the contract.

Construction Methods

Use uniformed Law Enforcement Officers and marked Law Enforcement vehicles equipped with blue lights mounted on top of the vehicle, and Law Enforcement vehicle emblems to direct or control traffic as required by the plans or by the Engineer.

Measurement and Payment

Law Enforcement will be measured and paid for in the actual number of hours that each Law Enforcement Officer is provided during the life of the project as approved by the Engineer. There will be no direct payment for marked Law Enforcement vehicles as they are considered incidental to the pay item.

Payment will be made under:

Pay Item

Law Enforcement

Pay Unit

Hour



DocuSigned by:
Steve Kite
E27CE30E1DFC442...
10/12/2016

Longitudinal Channelizing Curb System

(A) General

This provision specifies requirements for a longitudinal channelizing curb system. The longitudinal channelizing curb system shall consist of three main components: an interlocking series of raised separator units, curb system vertical markers and profile reflectors. The system shall be NCHRP 350 crash tested and shall be listed on the Agency's "Approved Products List".

(1) **Raised Separator:** The raised separator shall consist of two basic units: a separator unit and a tapered end unit. The raised separator shall be composed of recycled plastic with a sufficient durable mass to achieve a weight of at least 10 pounds per linear foot to resist the crushing effects of traffic impacts. The raised separator shall be a 10" – 12" in width, and a 3 1/2" - 4" in height. The raised separator cross section shall be curved so as to provide minimal resistance to vehicle tires. The entire surface of the raised separator shall be colored to conform to the traffic pavement markings that they supplement.

The raised separator units shall be in portable sections 3' – 4' in length. The units must fasten together by bolting each unit to a connecting metal device molded securely into the adjoining unit and be capable of holding the individual separator units together and in position on the roadway without the need for fasteners. Each individual separator unit will have a receptacle for the installation of a vertical marker and a receptacle capable of installing a reflecting element.

Tapered end units shall be bolted at the beginning and end of each run of separator units. The tapered end units shall be 1' – 2' in length and be capable of receiving a reflecting element.

The raised separator shall be installed following the manufacturer's installation procedures for anchoring the system into different types of road surfaces. The raised separator shall be installed using only the anchoring and fastening hardware provided by the manufacturer.

(2) **Vertical Markers:** The vertical markers shall be composed of UV-stabilized high impact plastic. Each vertical marker shall be affixed to a detachable flexible rubber boot or similar device that supports the marker in a vertical position, and is capable of restoring the marker to the vertical position if struck by a vehicle. The vertical marker shall be capable of sustaining a minimum of twenty (20) direct wheel-over impacts at 55 MPH without damage to the vertical marker or reflective sheeting applied to the vertical marker. The vertical marker shall accommodate Grade C high intensity retro-reflective sheeting or better that meets the requirements of Section 1092. The color of the retro-reflective sheeting shall match that of the raised separator units.

Round vertical markers shall have a mounting height of 35" – 37" above the roadway and be between 4" and 6" in diameter at the thinnest point on the marker. The round vertical markers shall have an overall round appearance so that reflective sheeting is visible from any direction around the marker. Round vertical markers shall accommodate at least two 4" bands of Grade C high intensity sheeting providing a retro-reflective area of 50 to 90 square inches facing traffic.

Elliptical markers shall be 8” – 10” wide and have a mounting height of 42” – 44” above the roadway. Elliptical markers shall accommodate Grade C high intensity sheeting 8” – 9” in width and 29” – 30” in height providing a retro-reflective area of 230 to 270 square inches facing the traffic. Elliptical markers can only be used as alternative to the round vertical markers to channelize the approach to railroad crossings.

(3) Profile Reflectors: The profile reflector is a snap-in arc with seven reflecting elements on each side and should be designed to depict the raised profile of the raised separator. Reflecting element should be installed on all raised separator units and on all male end units. The individual reflective “cat’s eyes” shall be between 8 – 10 mm in diameter and have the following photometric performance data in millicandela per lux (mcd/lux) for the inclination angle of 0°:

Angle of Observation α	Entrance Angle β	Amber (mcd/lux)	White (mcd/lux)
0.3°	5°	68	136
0.5°	10°	42	85
1.0°	10°	16	35
2.0°	15°	2.2	4.5

(B) Material Certification

Furnish Type 3 Material Certification in accordance with Article 106-3 for vertical markers.

(C) Approval

All materials are subject to the approval of the Engineer.

(D) Measurement and Payment

Payment will be made under:

Pay Item

Longitudinal Channelizing Curb System

Linear Foot



DocuSigned by:
Matthew V. Springer
BC60F6E8B584403...
1/3/2019

EXTRUDED THERMOPLASTIC PAVEMENT MARKING THICKNESS:

(03-19-19)

Revise the *2018 Standard Specifications* as follows:

Page 12-6, Subarticle 1205-4(A)(1) General, lines 5-8, delete the second sentence and replace with the following:

Use application equipment that provides multiple width settings ranging from 4 inches to 12 inches and multiple thickness settings to achieve a minimum pavement marking thickness of 0.090 inch above the surface of the pavement.

Page 12-7, Table 1205-3, THICKNESS REQUIREMENTS FOR THERMOPLASTIC, replace with the following:

TABLE 1205-3 MINIMUM THICKNESS REQUIREMENTS FOR THERMOPLASTIC	
Thickness	Location
240 mils	In-lane and shoulder-transverse pavement markings (rumble strips). May be placed in 2 passes.
90 mils	Center lines, skip lines, transverse bands, mini-skip lines, characters, bike lane symbols, crosswalk lines, edge lines, gore lines, diagonals, and arrow symbols

THERMOPLASTIC PAVEMENT MARKING MATERIAL – COLOR TESTING:

3-19-19

1087

SP10 R05

Revise the *2018 Standard Specifications* as follows:

Pages 10-183 and 10-184, Subarticle 1087-7(D)(1)(b) Yellow, lines 9-11, delete and replace with the following:

Obtain Color Values Y,x,y per ASTM E1349 using C/2° illuminant/observer.
Results shall be $Y \geq 45\%$, and x,y shall fall within PR#1 chart chromaticity limits.

PERMANENT SEEDING AND MULCHING:

(7-1-95)

1660

SP16 R02

The Department desires that permanent seeding and mulching be established on this project as soon as practical after slopes or portions of slopes have been graded. As an incentive to obtain an early stand of vegetation on this project, the Contractor's attention is called to the following:

For all permanent seeding and mulching that is satisfactorily completed in accordance with the requirements of Section 1660 in the *2018 Standard Specifications* and within the following percentages of elapsed contract times, an additional payment will be made to the Contractor as an incentive additive. The incentive additive will be determined by multiplying the number of acres of seeding and mulching satisfactorily completed times the contract unit bid price per acre for Seeding and Mulching times the appropriate percentage additive.

Percentage of Elapsed Contract Time	Percentage Additive
0% - 30%	30%
30.01% - 50%	15%

Percentage of elapsed contract time is defined as the number of calendar days from the date of availability of the contract to the date the permanent seeding and mulching is acceptably completed divided by the total original contract time.

STANDARD SPECIAL PROVISION
AVAILABILITY OF FUNDS – TERMINATION OF CONTRACTS

(5-20-08)

Z-2

General Statute 143C-6-11. (h) Highway Appropriation is hereby incorporated verbatim in this contract as follows:

(h) Amounts Encumbered. – Transportation project appropriations may be encumbered in the amount of allotments made to the Department of Transportation by the Director for the estimated payments for transportation project contract work to be performed in the appropriation fiscal year. The allotments shall be multiyear allotments and shall be based on estimated revenues and shall be subject to the maximum contract authority contained in *General Statute 143C-6-11(c)*. Payment for transportation project work performed pursuant to contract in any fiscal year other than the current fiscal year is subject to appropriations by the General Assembly. Transportation project contracts shall contain a schedule of estimated completion progress, and any acceleration of this progress shall be subject to the approval of the Department of Transportation provided funds are available. The State reserves the right to terminate or suspend any transportation project contract, and any transportation project contract shall be so terminated or suspended if funds will not be available for payment of the work to be performed during that fiscal year pursuant to the contract. In the event of termination of any contract, the contractor shall be given a written notice of termination at least 60 days before completion of scheduled work for which funds are available. In the event of termination, the contractor shall be paid for the work already performed in accordance with the contract specifications.

Payment will be made on any contract terminated pursuant to the special provision in accordance with Subarticle 108-13(D) of the *2018 Standard Specifications*.

STANDARD SPECIAL PROVISION
NCDOT GENERAL SEED SPECIFICATION FOR SEED QUALITY

(5-17-11)

Z-3

Seed shall be sampled and tested by the North Carolina Department of Agriculture and Consumer Services, Seed Testing Laboratory. When said samples are collected, the vendor shall supply an independent laboratory report for each lot to be tested. Results from seed so sampled shall be final. Seed not meeting the specifications shall be rejected by the Department of Transportation and shall not be delivered to North Carolina Department of Transportation warehouses. If seed has been delivered it shall be available for pickup and replacement at the supplier’s expense.

Any re-labeling required by the North Carolina Department of Agriculture and Consumer Services, Seed Testing Laboratory, that would cause the label to reflect as otherwise specified herein shall be rejected by the North Carolina Department of Transportation.

Seed shall be free from seeds of the noxious weeds Johnsongrass, Balloonvine, Jimsonweed, Witchweed, Itchgrass, Serrated Tussock, Showy Crotalaria, Smooth Crotalaria, Sicklepod, Sandbur, Wild Onion, and Wild Garlic. Seed shall not be labeled with the above weed species on the seed analysis label. Tolerances as applied by the Association of Official Seed Analysts will NOT be allowed for the above noxious weeds except for Wild Onion and Wild Garlic.

Tolerances established by the Association of Official Seed Analysts will generally be recognized. However, for the purpose of figuring pure live seed, the found pure seed and found germination percentages as reported by the North Carolina Department of Agriculture and Consumer Services, Seed Testing Laboratory will be used. Allowances, as established by the NCDOT, will be recognized for minimum pure live seed as listed on the following pages.

The specifications for restricted noxious weed seed refers to the number per pound as follows:

<u>Restricted Noxious Weed</u>	<u>Limitations per Lb. Of Seed</u>	<u>Restricted Noxious Weed</u>	<u>Limitations per Lb. of Seed</u>
Blessed Thistle	4 seeds	Cornflower (Ragged Robin)	27 seeds
Cocklebur	4 seeds	Texas Panicum	27 seeds
Spurred Anoda	4 seeds	Bracted Plantain	54 seeds
Velvetleaf	4 seeds	Buckhorn Plantain	54 seeds
Morning-glory	8 seeds	Broadleaf Dock	54 seeds
Corn Cockle	10 seeds	Curly Dock	54 seeds
Wild Radish	12 seeds	Dodder	54 seeds
Purple Nutsedge	27 seeds	Giant Foxtail	54 seeds
Yellow Nutsedge	27 seeds	Horsenettle	54 seeds
Canada Thistle	27 seeds	Quackgrass	54 seeds
Field Bindweed	27 seeds	Wild Mustard	54 seeds
Hedge Bindweed	27 seeds		

Seed of Pensacola Bahiagrass shall not contain more than 7% inert matter, Kentucky Bluegrass, Centipede and Fine or Hard Fescue shall not contain more than 5% inert matter whereas a maximum of 2% inert matter will be allowed on all other kinds of seed. In addition, all seed shall not contain more than 2% other crop seed nor more than 1% total weed seed. The germination rate as tested by the North Carolina Department of Agriculture shall not fall below 70%, which includes both dormant and hard seed. Seed shall be labeled

with not more than 7%, 5% or 2% inert matter (according to above specifications), 2% other crop seed and 1% total weed seed.

Exceptions may be made for minimum pure live seed allowances when cases of seed variety shortages are verified. Pure live seed percentages will be applied in a verified shortage situation. Those purchase orders of deficient seed lots will be credited with the percentage that the seed is deficient.

FURTHER SPECIFICATIONS FOR EACH SEED GROUP ARE GIVEN BELOW:

Minimum 85% pure live seed; maximum 1% total weed seed; maximum 2% total other crop seed; maximum 144 restricted noxious weed seed per pound. Seed less than 83% pure live seed will not be approved.

Sericea Lespedeza
Oats (seeds)

Minimum 80% pure live seed; maximum 1% total weed seed; maximum 2% total other crop; maximum 144 restricted noxious weed seed per pound. Seed less than 78% pure live seed will not be approved.

Tall Fescue (all approved varieties)	Bermudagrass
Kobe Lespedeza	Browntop Millet
Korean Lespedeza	German Millet – Strain R
Weeping Lovegrass	Clover – Red/White/Crimson
Carpetgrass	

Minimum 78% pure live seed; maximum 1% total weed seed; maximum 2% total other crop seed; maximum 144 restricted noxious weed seed per pound. Seed less than 76% pure live seed will not be approved.

Common or Sweet Sundangrass

Minimum 76% pure live seed; maximum 1% total weed seed; maximum 2% total other crop seed; maximum 144 restricted noxious weed seed per pound. Seed less than 74% pure live seed will not be approved.

Rye (grain; all varieties)
Kentucky Bluegrass (all approved varieties)
Hard Fescue (all approved varieties)
Shrub (bicolor) Lespedeza

Minimum 70% pure live seed; maximum 1% total weed seed; maximum 2% total other crop seed; maximum 144 noxious weed seed per pound. Seed less than 70% pure live seed will not be approved.

Centipedegrass	Japanese Millet
Crownvetch	Reed Canary Grass
Pensacola Bahiagrass	Zoysia
Creeping Red Fescue	

Minimum 70% pure live seed; maximum 1% total weed seed; maximum 2% total other crop seed; maximum 5% inert matter; maximum 144 restricted noxious weed seed per pound.

Barnyard Grass
Big Bluestem
Little Bluestem

Bristly Locust
Birdsfoot Trefoil
Indiangrass
Orchardgrass
Switchgrass
Yellow Blossom Sweet Clover

STANDARD SPECIAL PROVISION**ERRATA**

(10-16-18) (Rev.1-15-19)

Revise the *2018 Standard Specifications* as follows:

Division 6

Page 6-7, Article 609-1 DESCRIPTION, line 29, replace article number “609-10” with “609-9”.

Division 7

Page 7-27, Article 725-1 MEASUREMENT AND PAYMENT, line 4, replace article number “725-1” with “724-4”.

Page 7-28, Article 725-1 MEASUREMENT AND PAYMENT, line 10, replace article number “725-1” with “725-3”.

Division 10

Page 10-78, Article 1056-4 GEOTEXTILES, TABLE 1056-1, Permittivity, Type 2, replace “Table 6^D” with “Table 7^D” and **Permittivity, Type 3^B,** replace “Table 7^D” with “Table 8^D”.

Page 10-162, Article 1080-50 PAINT FOR VERTICAL MARKERS, line 1, replace article number “1080-50” with “1080-10”.

Page 10-162, Article 1080-61 EPOXY RESIN FOR REINFORCING STEEL, line 5, replace article number “1080-61” with “1080-11”.

Page 10-162, Article 1080-72 ABRASIVE MATERIALS FOR BLAST CLEANING STEEL, line 22, replace article number “1080-72” with “1080-12”.

Page 10-163, Article 1080-83 FIELD PERFORMANCE AND SERVICES, line 25, replace article number “1080-83” with “1080-13”.

Division 17

Page 17-15, Article 1715-4 MEASUREMENT AND PAYMENT, lines 42-44, replace the second sentence with the following:

An example is an installation of a single 1.25 inch HDPE conduit would be paid as:

Directional Drill (1)(1.25”) Linear Foot

STANDARD SPECIAL PROVISION**PLANT AND PEST QUARANTINES****(Imported Fire Ant, Gypsy Moth, Witchweed, Emerald Ash Borer, Guava Root Knot Nematode,
And Other Noxious Weeds)**

(3-18-03) (Rev. 5-21-19)

Z-04a

Within Quarantined Area

This project may be within a county regulated for plant and/or pests. If the project or any part of the Contractor's operations is located within a quarantined area, thoroughly clean all equipment prior to moving out of the quarantined area. Comply with federal/state regulations by obtaining a certificate or limited permit for any regulated article moving from the quarantined area.

Originating in a Quarantined County

Obtain a certificate or limited permit issued by the N.C. Department of Agriculture/United States Department of Agriculture. Have the certificate or limited permit accompany the article when it arrives at the project site.

Contact

Contact the N.C. Department of Agriculture/United States Department of Agriculture at 1-800-206-9333, 919-707-3730, or <https://www.ncagr.gov/plantindustry/Plant/quaran/table2.htm> to determine those specific project sites located in the quarantined area or for any regulated article used on this project originating in a quarantined county.

Regulated Articles Include

1. Soil, sand, gravel, compost, peat, humus, muck, and decomposed manure, separately or with other articles. This includes movement of articles listed above that may be associated with cut/waste, ditch pulling, and shoulder cutting.
2. Plants with roots including grass sod.
3. Plant crowns and roots.
4. Bulbs, corms, rhizomes, and tubers of ornamental plants.
5. Hay, straw, fodder, and plant litter of any kind.
6. Clearing and grubbing debris.
7. Used agricultural cultivating and harvesting equipment.
8. Used earth-moving equipment.
9. Any other products, articles, or means of conveyance, of any character, if determined by an inspector to present a hazard of spreading imported fire ant, gypsy moth, witchweed, emerald ash borer, guava root knot nematode, or other noxious weeds.

STANDARD SPECIAL PROVISION**TITLE VI AND NONDISCRIMINATION:**

(6-28-77)(Rev 6/19/2018)

Z-6

Revise the *2018 Standard Specifications* as follows:

Replace Article 103-4(B) with the following:

The North Carolina Department of Transportation is committed to carrying out the U.S. Department of Transportation's policy of ensuring nondiscrimination in the award and administration of contracts.

The provisions of this section related to United States Department of Transportation (US DOT) Order 1050.2A, Title 49 Code of Federal Regulations (CFR) part 21, 23 United States Code (U.S.C.) 140 and 23 CFR part 200 (or 49 CFR 303, 49 U.S.C. 5332 or 49 U.S.C. 47123) are applicable to all North Carolina Department of Transportation (NCDOT) contracts and to all related subcontracts, material supply, engineering, architectural and other service contracts, regardless of dollar amount. Any Federal provision that is specifically required not specifically set forth is hereby incorporated by reference.

(1) Title VI Assurances (USDOT Order 1050.2A, Appendix A)

During the performance of this contract, the contractor, for itself, its assignees, and successors in interest (hereinafter referred to as the "contractor") agrees as follows:

(a) Compliance with Regulations

The contractor (hereinafter includes consultants) shall comply with the Acts and the Regulations relative to Nondiscrimination in Federally-assisted programs of the U.S. Department of Transportation, Federal Highway Administration (FHWA), as they may be amended from time to time, which are herein incorporated by reference and made a part of this contract.

(b) Nondiscrimination

The contractor, with regard to the work performed by it during the contract, shall not discriminate on the grounds of race, color, or national origin in the selection and retention of subcontractors, including procurements of materials and leases of equipment. The contractor shall not participate directly or indirectly in the discrimination prohibited by the Acts and the Regulations, including employment practices when the contract covers any activity, project, or program set forth in Appendix B of 49 CFR Part 21.

(c) Solicitations for Subcontractors, Including Procurements of Materials and Equipment

In all solicitations, either by competitive bidding, or negotiation made by the contractor for work to be performed under a subcontract, including procurements of materials, or leases of equipment, each potential subcontractor or supplier shall be notified by the contractor of the contractor's obligations under this contract and the Acts and the Regulations relative to Nondiscrimination on the grounds of race, color, or national origin.

(d) Information and Reports

The contractor shall provide all information and reports required by the Acts, the Regulations, and directives issued pursuant thereto and shall permit access to its books, records, accounts, other sources of information, and its facilities as may be determined by the Recipient or the FHWA to be pertinent to ascertain compliance with such Acts, Regulations, and instructions. Where any information required of a contractor is in the exclusive possession of another who fails or refuses to furnish the information, the contractor shall so certify to the Recipient or the FHWA, as appropriate, and shall set forth what efforts it has made to obtain the information.

(e) Sanctions for Noncompliance:

In the event of a contractor's noncompliance with the Non-discrimination provisions of this contract, the Recipient will impose such contract sanctions as it and/or the FHWA may determine to be appropriate, including, but not limited to:

- (i) Withholding payments to the contractor under the contract until the contractor complies; and/or
 - (ii) Cancelling, terminating, or suspending a contract, in whole or in part.
- (f) Incorporation of Provisions

The contractor shall include the provisions of paragraphs (a) through (f) in every subcontract, including procurements of materials and leases of equipment, unless exempt by the Acts, the Regulations and directives issued pursuant thereto. The contractor shall take action with respect to any subcontract or procurement as the Recipient or the FHWA may direct as a means of enforcing such provisions including sanctions for noncompliance. Provided, that if the contractor becomes involved in, or is threatened with litigation by a subcontractor, or supplier because of such direction, the contractor may request the Recipient to enter into any litigation to protect the interests of the Recipient. In addition, the contractor may request the United States to enter into the litigation to protect the interests of the United States.

(2) Title VI Nondiscrimination Program (23 CFR 200.5(p))

The North Carolina Department of Transportation (NCDOT) has assured the USDOT that, as a condition to receiving federal financial assistance, NCDOT will comply with Title VI of the Civil Rights Act of 1964 and all requirements imposed by Title 49 CFR part 21 and related nondiscrimination authorities to ensure that no person shall, on the ground of race, color, national origin, limited English proficiency, sex, age, or disability (including religion/creed or income-level, where applicable), be excluded from participation in, be denied the benefits of, or be subjected to discrimination under any programs, activities, or services conducted or funded by NCDOT. Contractors and other organizations under contract or agreement with NCDOT must also comply with Title VI and related authorities, therefore:

- (a) During the performance of this contract or agreement, contractors (e.g., subcontractors, consultants, vendors, prime contractors) are responsible for complying with NCDOT's Title VI Program. Contractors are not required to prepare or submit Title VI Programs. To comply with this section, the prime contractor shall:
 1. Post NCDOT's Notice of Nondiscrimination and the Contractor's own Equal Employment Opportunity (EEO) Policy in conspicuous locations accessible to all employees, applicants and subcontractors on the jobsite.
 2. Physically incorporate the required Title VI clauses into all subcontracts on federally-assisted and state-funded NCDOT projects, and ensure inclusion by subcontractors into all lower-tier subcontracts.
 3. Required Solicitation Language. The Contractor shall include the following notification in all solicitations for bids and requests for work or material, regardless of funding source:

“The North Carolina Department of Transportation, in accordance with the provisions of Title VI of the Civil Rights Act of 1964 (78 Stat. 252, 42 U.S.C. §§ 2000d to 2000d-4) and the Regulations, hereby notifies all bidders that it will affirmatively ensure that any contract entered into pursuant to this advertisement, disadvantaged business enterprises will be afforded full and fair opportunity to submit bids in response to this invitation and will not be discriminated against on the grounds of race, color, or national origin in consideration for an award. In accordance with other related nondiscrimination authorities, bidders and contractors will also not be discriminated against on the grounds of sex, age, disability, low-income level, creed/religion, or limited English proficiency in consideration for an award.”

4. Physically incorporate the FHWA-1273, in its entirety, into all subcontracts and subsequent lower tier subcontracts on Federal-aid highway construction contracts only.
 5. Provide language assistance services (i.e., written translation and oral interpretation), free of charge, to LEP employees and applicants. Contact NCDOT OCR for further assistance, if needed.
 6. For assistance with these Title VI requirements, contact the NCDOT Title VI Nondiscrimination Program at 1-800-522-0453.
- (b) Subrecipients (e.g. cities, counties, LGAs, planning organizations) may be required to prepare and submit a Title VI Plan to NCDOT, including Title VI Assurances and/or agreements. Subrecipients must also ensure compliance by their contractors and subrecipients with Title VI. (23 CFR 200.9(b)(7))
- (c) If reviewed or investigated by NCDOT, the contractor or subrecipient agrees to take affirmative action to correct any deficiencies found within a reasonable time period, not to exceed 90 calendar days, unless additional time is granted by NCDOT. (23 CFR 200.9(b)(15))
- (d) The Contractor is responsible for notifying subcontractors of NCDOT's External Discrimination Complaints Process.
1. **Applicability**
Title VI and related laws protect participants and beneficiaries (e.g., members of the public and contractors) from discrimination by NCDOT employees, subrecipients and contractors, regardless of funding source.
 2. **Eligibility**
Any person—or class of persons—who believes he/she has been subjected to discrimination based on race, color, national origin, Limited English Proficiency (LEP), sex, age, or disability (and religion in the context of employment, aviation, or transit) may file a written complaint. The law also prohibits intimidation or retaliation of any sort.
 3. **Time Limits and Filing Options**
Complaints may be filed by the affected individual(s) or a representative and must be filed no later than 180 calendar days after the following:
 - (i) The date of the alleged act of discrimination; or
 - (ii) The date when the person(s) became aware of the alleged discrimination; or
 - (iii) Where there has been a continuing course of conduct, the date on which that conduct was discontinued or the latest instance of the conduct.Title VI and related discrimination complaints may be submitted to the following entities:
 - North Carolina Department of Transportation, Office of Civil Rights, Title VI Program, 1511 Mail Service Center, Raleigh, NC 27699-1511; toll free 1-800-522-0453
 - Federal Highway Administration, North Carolina Division Office, 310 New Bern Avenue, Suite 410, Raleigh, NC 27601, 919-747-7010
 - US Department of Transportation, Departmental Office of Civil Rights, External Civil Rights Programs Division, 1200 New Jersey Avenue, SE, Washington, DC 20590; 202-366-4070
 4. **Format for Complaints**
Complaints must be in writing and signed by the complainant(s) or a representative, and include the complainant's name, address, and telephone number. Complaints received by fax or e-mail will be acknowledged and processed. Allegations received by telephone will be reduced to writing and provided to the complainant for confirmation or revision before processing. Complaints will be accepted in other languages, including Braille.
 5. **Discrimination Complaint Form**
Contact NCDOT Civil Rights to receive a full copy of the Discrimination Complaint Form and procedures.

6. Complaint Basis

Allegations must be based on issues involving race, color, national origin (LEP), sex, age, disability, or religion (in the context of employment, aviation or transit). “Basis” refers to the complainant’s membership in a protected group category.

TABLE 103-1 COMPLAINT BASIS			
Protected Categories	Definition	Examples	Applicable Nondiscrimination Authorities
Race and Ethnicity	An individual belonging to one of the accepted racial groups; or the perception, based usually on physical characteristics that a person is a member of a racial group	Black/African American, Hispanic/Latino, Asian, American Indian/Alaska Native, Native Hawaiian/Pacific Islander, White	Title VI of the Civil Rights Act of 1964; 49 CFR Part 21; 23 CFR 200; 49 U.S.C. 5332(b); 49 U.S.C. 47123. <i>(Executive Order 13166)</i>
Color	Color of skin, including shade of skin within a racial group	Black, White, brown, yellow, etc.	
National Origin <i>(Limited English Proficiency)</i>	Place of birth. Citizenship is not a factor. <i>(Discrimination based on language or a person’s accent is also covered)</i>	Mexican, Cuban, Japanese, Vietnamese, Chinese	
Sex	Gender. The sex of an individual. <i>Note: Sex under this program does not include sexual orientation.</i>	Women and Men	1973 Federal-Aid Highway Act; 49 U.S.C. 5332(b); 49 U.S.C. 47123.
Age	Persons of any age	21-year-old person	Age Discrimination Act of 1975 49 U.S.C. 5332(b); 49 U.S.C. 47123.
Disability	Physical or mental impairment, permanent or temporary, or perceived.	Blind, alcoholic, para-amputee, epileptic, diabetic, arthritic	Section 504 of the Rehabilitation Act of 1973; Americans with Disabilities Act of 1990
Religion (in the context of employment) <i>(Religion/ Creed in all aspects of any aviation or transit-related construction)</i>	An individual belonging to a religious group; or the perception, based on distinguishable characteristics that a person is a member of a religious group. In practice, actions taken as a result of the moral and ethical beliefs as to what is right and wrong, which are sincerely held with the strength of traditional religious views. <i>Note: Does not have to be associated with a recognized religious group or church; if an individual sincerely holds to the belief, it is a protected religious practice.</i>	Muslim, Christian, Sikh, Hindu, etc.	Title VII of the Civil Rights Act of 1964; 23 CFR 230; FHWA-1273 Required Contract Provisions. <i>(49 U.S.C. 5332(b); 49 U.S.C. 47123)</i>

(3) Pertinent Nondiscrimination Authorities

During the performance of this contract, the contractor, for itself, its assignees, and successors in interest agrees to comply with the following non-discrimination statutes and authorities, including, but not limited to:

- (a) Title VI of the Civil Rights Act of 1964 (42 U.S.C. § 2000d et seq., 78 stat. 252), (prohibits discrimination on the basis of race, color, national origin); and 49 CFR Part 21.
- (b) The Uniform Relocation Assistance and Real Property Acquisition Policies Act of 1970, (42 U.S.C. § 4601), (prohibits unfair treatment of persons displaced or whose property has been acquired because of Federal or Federal-aid programs and projects);
- (c) Federal-Aid Highway Act of 1973, (23 U.S.C. § 324 et seq.), (prohibits discrimination on the basis of sex);
- (d) Section 504 of the Rehabilitation Act of 1973, (29 U.S.C. § 794 et seq.), as amended, (prohibits discrimination on the basis of disability) and 49 CFR Part 27;
- (e) The Age Discrimination Act of 1975, as amended, (42 U.S.C. § 6101 et seq.), (prohibits discrimination on the basis of age);
- (f) Airport and Airway Improvement Act of 1982, (49 USC § 471, Section 47123), as amended, (prohibits discrimination based on race, creed, color, national origin, or sex);
- (g) The Civil Rights Restoration Act of 1987, (PL 100-209), (Broadened the scope, coverage and applicability of Title VI of the Civil Rights Act of 1964, The Age Discrimination Act of 1975 and Section 504 of the Rehabilitation Act of 1973, by expanding the definition of the terms "programs or activities" to include all of the programs or activities of the Federal-aid recipients, sub-recipients and contractors, whether such programs or activities are Federally funded or not);
- (h) Titles II and III of the Americans with Disabilities Act, which prohibit discrimination on the basis of disability in the operation of public entities, public and private transportation systems, places of public accommodation, and certain testing entities (42 U.S.C. §§ 12131-12189) as implemented by Department of Transportation regulations at 49 C.F.R. parts 37 and 38;
- (i) The Federal Aviation Administration's Nondiscrimination statute (49 U.S.C. § 47123) (prohibits discrimination on the basis of race, color, national origin, and sex);
- (j) Executive Order 12898, Federal Actions to Address Environmental Justice in Minority Populations and Low-Income Populations, which ensures Nondiscrimination against minority populations by discouraging programs, policies, and activities with disproportionately high and adverse human health or environmental effects on minority and low-income populations;
- (k) Executive Order 13166, Improving Access to Services for Persons with Limited English Proficiency, and resulting agency guidance, national origin discrimination includes discrimination because of Limited English proficiency (LEP). To ensure compliance with Title VI, you must take reasonable steps to ensure that LEP persons have meaningful access to your programs (70 Fed. Reg. at 74087 to 74100);
- (l) Title IX of the Education Amendments of 1972, as amended, which prohibits you from discriminating because of sex in education programs or activities (20 U.S.C. 1681 et seq).
- (m) Title VII of the Civil Rights Act of 1964 (42 U.S.C. § 2000e et seq., Pub. L. 88-352), (prohibits employment discrimination on the basis of race, color, religion, sex, or national origin).

(4) **Additional Title VI Assurances**

***The following Title VI Assurances (Appendices B, C and D) shall apply, as applicable*

- (a) Clauses for Deeds Transferring United States Property (1050.2A, Appendix B)
The following clauses will be included in deeds effecting or recording the transfer of real property, structures, or improvements thereon, or granting interest therein from the United States pursuant to the provisions of Assurance 4.

NOW, THEREFORE, the U.S. Department of Transportation as authorized by law and upon the condition that the North Carolina Department of Transportation (NCDOT) will accept title to the lands and maintain the project constructed thereon in accordance with the North Carolina General Assembly, the Regulations for the Administration of the Federal-Aid Highway Program, and the policies and procedures prescribed by the Federal Highway Administration of the U.S. Department of Transportation in accordance and in compliance with all requirements imposed by Title 49, Code of Federal Regulations, U.S. Department of Transportation, Subtitle A, Office of the Secretary, Part 21, Nondiscrimination in Federally-assisted programs of the U.S. Department of Transportation pertaining to and effectuating the provisions of Title VI of the Civil Rights Act of 1964 (78 Stat. 252; 42 U.S.C. § 2000d to 2000d-4), does hereby remise, release, quitclaim and convey unto the NCDOT all the right, title and interest of the U.S. Department of Transportation in and to said lands described in Exhibit A attached hereto and made a part hereof.

(HABENDUM CLAUSE)

TO HAVE AND TO HOLD said lands and interests therein unto the North Carolina Department of Transportation (NCDOT) and its successors forever, subject, however, to the covenants, conditions, restrictions and reservations herein contained as follows, which will remain in effect for the period during which the real property or structures are used for a purpose for which Federal financial assistance is extended or for another purpose involving the provision of similar services or benefits and will be binding on the NCDOT, its successors and assigns.

The NCDOT, in consideration of the conveyance of said lands and interests in lands, does hereby covenant and agree as a covenant running with the land for itself, its successors and assigns, that (1) no person will on the grounds of race, color, or national origin, be excluded from participation in, be denied the benefits of, or be otherwise subjected to discrimination with regard to any facility located wholly or in part on, over, or under such lands hereby conveyed [,] [and]* (2) that the NCDOT will use the lands and interests in lands and interests in lands so conveyed, in compliance with all requirements imposed by or pursuant to Title 49, Code of Federal Regulations, U.S. Department of Transportation, Subtitle A, Office of the Secretary, Part 21, Non-discrimination in Federally-assisted programs of the U.S. Department of Transportation, Effectuation of Title VI of the Civil Rights Act of 1964, and as said Regulations and Acts may be amended [, and (3) that in the event of breach of any of the above-mentioned nondiscrimination conditions, the Department will have a right to enter or re-enter said lands and facilities on said land, and that above described land and facilities will thereon revert to and vest in and become the absolute property of the U.S. Department of Transportation and its assigns as such interest existed prior to this instruction].*

(*Reverter clause and related language to be used only when it is determined that such a clause is necessary in order to make clear the purpose of Title VI.)

(b) Clauses for Transfer of Real Property Acquired or Improved Under the Activity, Facility, or Program (1050.2A, Appendix C)

The following clauses will be included in deeds, licenses, leases, permits, or similar instruments entered into by the North Carolina Department of Transportation (NCDOT) pursuant to the provisions of Assurance 7(a):

1. The (grantee, lessee, permittee, etc. as appropriate) for himself/herself, his/her heirs, personal representatives, successors in interest, and assigns, as a part of the consideration hereof, does hereby covenant and agree [in the case of deeds and leases add "as a covenant running with the land"] that:

- (i.) In the event facilities are constructed, maintained, or otherwise operated on the property described in this (deed, license, lease, permit, etc.) for a purpose for which a U.S. Department of Transportation activity, facility, or program is extended or for another purpose involving the provision of similar services or benefits, the (grantee, licensee, lessee, permittee, etc.) will maintain and operate such facilities and services in compliance with all requirements imposed by the Acts and Regulations (as may be amended) such that no person on the grounds of race, color, or national origin, will be excluded from participation in, denied the benefits of, or be otherwise subjected to discrimination in the use of said facilities.
- 2. With respect to licenses, leases, permits, etc., in the event of breach of any of the above Nondiscrimination covenants, the NCDOT will have the right to terminate the (lease, license, permit, etc.) and to enter, re-enter, and repossess said lands and facilities thereon, and hold the same as if the (lease, license, permit, etc.) had never been made or issued. *
- 3. With respect to a deed, in the event of breach of any of the above Nondiscrimination covenants, the NCDOT will have the right to enter or re-enter the lands and facilities thereon, and the above described lands and facilities will there upon revert to and vest in and become the absolute property of the NCDOT and its assigns. *

(*Reverter clause and related language to be used only when it is determined that such a clause is necessary to make clear the purpose of Title VI.)

(c) Clauses for Construction/Use/Access to Real Property Acquired Under the Activity, Facility or Program (1050.2A, Appendix D)

The following clauses will be included in deeds, licenses, permits, or similar instruments/agreements entered into by the North Carolina Department of Transportation (NCDOT) pursuant to the provisions of Assurance 7(b):

- 1. The (grantee, licensee, permittee, etc., as appropriate) for himself/herself, his/her heirs, personal representatives, successors in interest, and assigns, as a part of the consideration hereof, does hereby covenant and agree (in the case of deeds and leases add, "as a covenant running with the land") that (1) no person on the ground of race, color, or national origin, will be excluded from participation in, denied the benefits of, or be otherwise subjected to discrimination in the use of said facilities, (2) that in the construction of any improvements on, over, or under such land, and the furnishing of services thereon, no person on the ground of race, color, or national origin, will be excluded from participation in, denied the benefits of, or otherwise be subjected to discrimination, (3) that the (grantee, licensee, lessee, permittee, etc.) will use the premises in compliance with all other requirements imposed by or pursuant to the Acts and Regulations, as amended, set forth in this Assurance.
- 2. With respect to (licenses, leases, permits, etc.), in the event of breach of any of the above Non-discrimination covenants, the NCDOT will have the right to terminate the (license, permit, etc., as appropriate) and to enter or re-enter and repossess said land and the facilities thereon, and hold the same as if said (license, permit, etc., as appropriate) had never been made or issued. *
- 3. With respect to deeds, in the event of breach of any of the above Nondiscrimination covenants, the NCDOT will there upon revert to and vest in and become the absolute property of the NCDOT and its assigns. *

(*Reverter clause and related language to be used only when it is determined that such a clause is necessary to make clear the purpose of Title VI.)

STANDARD SPECIAL PROVISION**MINORITY AND FEMALE EMPLOYMENT REQUIREMENTS**

Z-7

NOTICE OF REQUIREMENTS FOR AFFIRMATIVE ACTION TO ENSURE EQUAL EMPLOYMENT OPPORTUNITY (*EXECUTIVE NUMBER 11246*)

1. The goals and timetables for minority and female participation, expressed in percentage terms for the Contractor's aggregate workforce in each trade on all construction work in the covered area, see as shown on the attached sheet entitled "Employment Goals for Minority and Female participation".

These goals are applicable to all the Contractor's construction work (whether or not it is Federal or federally assisted) performed in the covered area. If the Contractor performs construction work in a geographical area located outside of the covered area, it shall apply the goals established for such geographical area where the work is actually performed. With regard to this second area, the Contractor also is subject to the goals for both its federally involved and nonfederally involved construction.

The Contractor's compliance with the Executive Order and the regulations in *41 CFR Part 60-4* shall be based on its implementation of the Equal Opportunity Clause, specific affirmative action obligations required by the specifications set forth in *41 CFR 60-4.3(a)*, and its effort to meet the goals. The hours of minority and female employment and training must be substantially uniform throughout the length of the contract, and in each trade and the Contractor shall make a good faith effort to employ minorities and women evenly on each of its projects. The transfer of minority or female employees or trainees from Contractor to Contractor or from project to project for the sole purpose of meeting the Contractor's goals shall be a violation of the contract, the executive Order and the regulations in *41 CFR Part 60-4*. Compliance with the goals will be measured against the total work hours performed.

2. As used in this Notice and in the contract resulting from this solicitation, the "covered area" is the county or counties shown on the cover sheet of the proposal form and contract.

**EMPLOYMENT GOALS FOR MINORITY
AND FEMALE PARTICIPATION**

Economic Areas

Area 023 29.7%

Bertie County
Camden County
Chowan County
Gates County
Hertford County
Pasquotank County
Perquimans County

Area 024 31.7%

Beaufort County
Carteret County
Craven County
Dare County
Edgecombe County
Green County
Halifax County
Hyde County
Jones County
Lenoir County
Martin County
Nash County
Northampton County
Pamlico County
Pitt County
Tyrrell County
Washington County
Wayne County
Wilson County

Area 025 23.5%

Columbus County
Duplin County
Onslow County
Pender County

Area 026 33.5%

Bladen County
Hoke County
Richmond County
Robeson County
Sampson County
Scotland County

Area 027 24.7%

Chatham County
Franklin County
Granville County
Harnett County
Johnston County
Lee County
Person County
Vance County
Warren County

Area 028 15.5%

Alleghany County
Ashe County
Caswell County
Davie County
Montgomery County
Moore County
Rockingham County
Surry County
Watauga County
Wilkes County

Area 029 15.7%

Alexander County
Anson County
Burke County
Cabarrus County
Caldwell County
Catawba County
Cleveland County
Iredell County
Lincoln County
Polk County
Rowan County
Rutherford County
Stanly County

Area 0480 8.5%

Buncombe County
Madison County

Area 030 6.3%

Avery County
Cherokee County
Clay County
Graham County
Haywood County
Henderson County
Jackson County
McDowell County
Macon County
Mitchell County
Swain County
Transylvania County
Yancey County

SMSA AreasArea 5720 26.6%

Currituck County

Area 9200 20.7%

Brunswick County

New Hanover County

Area 2560 24.2%

Cumberland County

Area 6640 22.8%

Durham County

Orange County

Wake County

Area 1300 16.2%

Alamance County

Area 3120 16.4%

Davidson County

Forsyth County

Guilford County

Randolph County

Stokes County

Yadkin County

Area 1520 18.3%

Gaston County

Mecklenburg County

Union County

Goals for FemaleParticipation in Each Trade

(Statewide) 6.9%

STANDARD SPECIAL PROVISION

REQUIRED CONTRACT PROVISIONS FEDERAL - AID CONSTRUCTION CONTRACTS

FHWA - 1273 Electronic Version - May 1, 2012

Z-8

- I. General
- II. Nondiscrimination
- III. Nonsegregated Facilities
- IV. Davis-Bacon and Related Act Provisions
- V. Contract Work Hours and Safety Standards Act Provisions
- VI. Subletting or Assigning the Contract
- VII. Safety: Accident Prevention
- VIII. False Statements Concerning Highway Projects
- IX. Implementation of Clean Air Act and Federal Water Pollution Control Act
- X. Compliance with Governmentwide Suspension and Debarment Requirements
- XI. Certification Regarding Use of Contract Funds for Lobbying

ATTACHMENTS

- A. Employment and Materials Preference for Appalachian Development Highway System or Appalachian Local Access Road Contracts (included in Appalachian contracts only)

I. GENERAL

1. Form FHWA-1273 must be physically incorporated in each construction contract funded under Title 23 (excluding emergency contracts solely intended for debris removal). The contractor (or subcontractor) must insert this form in each subcontract and further require its inclusion in all lower tier subcontracts (excluding purchase orders, rental agreements and other agreements for supplies or services).
The applicable requirements of Form FHWA-1273 are incorporated by reference for work done under any purchase order, rental agreement or agreement for other services. The prime contractor shall be responsible for compliance by any subcontractor, lower-tier subcontractor or service provider.
Form FHWA-1273 must be included in all Federal-aid design-build contracts, in all subcontracts and in lower tier subcontracts (excluding subcontracts for design services, purchase orders, rental agreements and other agreements for supplies or services). The design-builder shall be responsible for compliance by any subcontractor, lower-tier subcontractor or service provider.
Contracting agencies may reference Form FHWA-1273 in bid proposal or request for proposal documents, however, the Form FHWA-1273 must be physically incorporated (not referenced) in all contracts, subcontracts and lower-tier subcontracts (excluding purchase orders, rental agreements and other agreements for supplies or services related to a construction contract).
2. Subject to the applicability criteria noted in the following sections, these contract provisions shall apply to all work performed on the contract by the contractor's own organization and with the assistance of workers under the contractor's immediate superintendence and to all work performed on the contract by piecework, station work, or by subcontract.
3. A breach of any of the stipulations contained in these Required Contract Provisions may be sufficient grounds for withholding of progress payments, withholding of final payment, termination of the contract, suspension / debarment or any other action determined to be appropriate by the contracting agency and FHWA.
4. Selection of Labor: During the performance of this contract, the contractor shall not use convict labor for any purpose within the limits of a construction project on a Federal-aid highway unless it is labor performed by convicts who are on parole, supervised release, or probation. The term Federal-aid highway does not include roadways functionally classified as local roads or rural minor collectors.

II. NONDISCRIMINATION

The provisions of this section related to 23 CFR Part 230 are applicable to all Federal-aid construction contracts and to all related construction subcontracts of \$10,000 or more. The provisions of 23 CFR Part 230 are not applicable to material supply, engineering, or architectural service contracts.

In addition, the contractor and all subcontractors must comply with the following policies: Executive Order 11246, 41 CFR 60, 29 CFR 1625-1627, Title 23 USC Section 140, the Rehabilitation Act of 1973, as amended (29 USC 794), Title VI of the Civil Rights Act of 1964, as amended, and related regulations including 49 CFR Parts 21, 26 and 27; and 23 CFR Parts 200, 230, and 633.

The contractor and all subcontractors must comply with: the requirements of the Equal Opportunity Clause in 41 CFR 60-1.4(b) and, for all construction contracts exceeding \$10,000, the Standard Federal Equal Employment Opportunity Construction Contract Specifications in 41 CFR 60-4.3.

Note: The U.S. Department of Labor has exclusive authority to determine compliance with Executive Order 11246 and the policies of the Secretary of Labor including 41 CFR 60, and 29 CFR 1625-1627. The contracting agency and the FHWA have the authority and the responsibility to ensure compliance with Title 23 USC Section 140, the Rehabilitation Act of 1973, as amended (29 USC 794), and Title VI of the Civil Rights Act of 1964, as amended, and related regulations including 49 CFR Parts 21, 26 and 27; and 23 CFR Parts 200, 230, and 633.

The following provision is adopted from 23 CFR 230, Appendix A, with appropriate revisions to conform to the U.S. Department of Labor (US DOL) and FHWA requirements.

1. **Equal Employment Opportunity:** Equal employment opportunity (EEO) requirements not to discriminate and to take affirmative action to assure equal opportunity as set forth under laws, executive orders, rules, regulations (28 CFR 35, 29 CFR 1630, 29 CFR 1625-1627, 41 CFR 60 and 49 CFR 27) and orders of the Secretary of Labor as modified by the provisions prescribed herein, and imposed pursuant to 23 U.S.C. 140 shall constitute the EEO and specific affirmative action standards for the contractor's project activities under this contract. The provisions of the Americans with Disabilities Act of 1990 (42 U.S.C. 12101 et seq.) set forth under 28 CFR 35 and 29 CFR 1630 are incorporated by reference in this contract. In the execution of this contract, the contractor agrees to comply with the following minimum specific requirement activities of EEO:

- a. The contractor will work with the contracting agency and the Federal Government to ensure that it has made every good faith effort to provide equal opportunity with respect to all of its terms and conditions of employment and in their review of activities under the contract.
- b. The contractor will accept as its operating policy the following statement:
"It is the policy of this Company to assure that applicants are employed, and that employees are treated during employment, without regard to their race, religion, sex, color, national origin, age or disability. Such action shall include: employment, upgrading, demotion, or transfer; recruitment or recruitment advertising; layoff or termination; rates of pay or other forms of compensation; and selection for training, including apprenticeship, pre-apprenticeship, and/or on-the-job training."
2. **EEO Officer:** The contractor will designate and make known to the contracting officers an EEO Officer who will have the responsibility for and must be capable of effectively administering and promoting an active EEO program and who must be assigned adequate authority and responsibility to do so.
3. **Dissemination of Policy:** All members of the contractor's staff who are authorized to hire, supervise, promote, and discharge employees, or who recommend such action, or who are substantially involved in such action, will be made fully cognizant of, and will implement, the contractor's EEO policy and contractual responsibilities to provide EEO in each grade and classification of employment. To ensure that the above agreement will be met, the following actions will be taken as a minimum:
 - a. Periodic meetings of supervisory and personnel office employees will be conducted before the start of work and then not less often than once every six months, at which time the contractor's EEO policy and its implementation will be reviewed and explained. The meetings will be conducted by the EEO Officer.
 - b. All new supervisory or personnel office employees will be given a thorough indoctrination by the EEO Officer, covering all major aspects of the contractor's EEO obligations within thirty days following their reporting for duty with the contractor.
 - c. All personnel who are engaged in direct recruitment for the project will be instructed by the EEO Officer in the contractor's procedures for locating and hiring minorities and women.
 - d. Notices and posters setting forth the contractor's EEO policy will be placed in areas readily accessible to employees, applicants for employment and potential employees.
 - e. The contractor's EEO policy and the procedures to implement such policy will be brought to the attention of employees by means of meetings, employee handbooks, or other appropriate means.
4. **Recruitment:** When advertising for employees, the contractor will include in all advertisements for employees the notation: "An Equal Opportunity Employer." All such advertisements will be placed in publications having a large circulation among minorities and women in the area from which the project work force would normally be derived.
 - a. The contractor will, unless precluded by a valid bargaining agreement, conduct systematic and direct recruitment through public and private employee referral sources likely to yield qualified minorities and women. To meet this requirement, the contractor will identify sources of potential minority group employees, and establish with such identified sources procedures whereby minority and women applicants may be referred to the contractor for employment consideration.
 - b. In the event the contractor has a valid bargaining agreement providing for exclusive hiring hall referrals, the contractor is expected to observe the provisions of that agreement to the extent that the system meets the contractor's compliance with EEO contract provisions. Where implementation of such an agreement has the effect of discriminating against minorities or women, or obligates the contractor to do the same, such implementation violates Federal nondiscrimination provisions.
 - c. The contractor will encourage its present employees to refer minorities and women as applicants for employment. Information and procedures with regard to referring such applicants will be discussed with employees.
5. **Personnel Actions:** Wages, working conditions, and employee benefits shall be established and administered, and personnel actions of every type, including hiring, upgrading, promotion, transfer, demotion, layoff, and termination, shall be taken without regard to race, color, religion, sex, national origin, age or disability. The following procedures shall be followed:
 - a. The contractor will conduct periodic inspections of project sites to insure that working conditions and employee facilities do not indicate discriminatory treatment of project site personnel.
 - b. The contractor will periodically evaluate the spread of wages paid within each classification to determine any evidence of discriminatory wage practices.
 - c. The contractor will periodically review selected personnel actions in depth to determine whether there is evidence of discrimination. Where evidence is found, the contractor will promptly take corrective action. If the review indicates that the discrimination may extend beyond the actions reviewed, such corrective action shall include all affected persons.
 - d. The contractor will promptly investigate all complaints of alleged discrimination made to the contractor in connection with its obligations under this contract, will attempt to resolve such complaints, and will take appropriate corrective action within a reasonable time. If the investigation indicates that the discrimination may affect persons other than the complainant, such corrective action shall include such other persons. Upon completion of each investigation, the contractor will inform every complainant of all of their avenues of appeal.
6. **Training and Promotion:**
 - a. The contractor will assist in locating, qualifying, and increasing the skills of minorities and women who are applicants for employment or current employees. Such efforts should be aimed at developing full journey level status employees in the type of trade or job classification involved.
 - b. Consistent with the contractor's work force requirements and as permissible under Federal and State regulations, the contractor shall make full use of training programs, i.e., apprenticeship, and on-the-job training programs for the geographical area of contract performance. In the event a special provision for training is provided under this contract, this subparagraph will be superseded as indicated in the special provision. The contracting agency may reserve training positions for persons who receive welfare assistance in accordance with 23 U.S.C. 140(a).
 - c. The contractor will advise employees and applicants for employment of available training programs and entrance requirements for each.
 - d. The contractor will periodically review the training and promotion potential of employees who are minorities and women and will encourage eligible employees to apply for such training and promotion.

7. **Unions:** If the contractor relies in whole or in part upon unions as a source of employees, the contractor will use good faith efforts to obtain the cooperation of such unions to increase opportunities for minorities and women. Actions by the contractor, either directly or through a contractor's association acting as agent, will include the procedures set forth below:
- a. The contractor will use good faith efforts to develop, in cooperation with the unions, joint training programs aimed toward qualifying more minorities and women for membership in the unions and increasing the skills of minorities and women so that they may qualify for higher paying employment.
 - b. The contractor will use good faith efforts to incorporate an EEO clause into each union agreement to the end that such union will be contractually bound to refer applicants without regard to their race, color, religion, sex, national origin, age or disability.
 - c. The contractor is to obtain information as to the referral practices and policies of the labor union except that to the extent such information is within the exclusive possession of the labor union and such labor union refuses to furnish such information to the contractor, the contractor shall so certify to the contracting agency and shall set forth what efforts have been made to obtain such information.
 - d. In the event the union is unable to provide the contractor with a reasonable flow of referrals within the time limit set forth in the collective bargaining agreement, the contractor will, through independent recruitment efforts, fill the employment vacancies without regard to race, color, religion, sex, national origin, age or disability; making full efforts to obtain qualified and/or qualifiable minorities and women. The failure of a union to provide sufficient referrals (even though it is obligated to provide exclusive referrals under the terms of a collective bargaining agreement) does not relieve the contractor from the requirements of this paragraph. In the event the union referral practice prevents the contractor from meeting the obligations pursuant to Executive Order 11246, as amended, and these special provisions, such contractor shall immediately notify the contracting agency.
8. **Reasonable Accommodation for Applicants / Employees with Disabilities:** The contractor must be familiar with the requirements for and comply with the Americans with Disabilities Act and all rules and regulations established there under. Employers must provide reasonable accommodation in all employment activities unless to do so would cause an undue hardship.
9. **Selection of Subcontractors, Procurement of Materials and Leasing of Equipment:** The contractor shall not discriminate on the grounds of race, color, religion, sex, national origin, age or disability in the selection and retention of subcontractors, including procurement of materials and leases of equipment. The contractor shall take all necessary and reasonable steps to ensure nondiscrimination in the administration of this contract.
- a. The contractor shall notify all potential subcontractors and suppliers and lessors of their EEO obligations under this contract.
 - b. The contractor will use good faith efforts to ensure subcontractor compliance with their EEO obligations.
10. **Assurance Required by 49 CFR 26.13(b):**
- a. The requirements of 49 CFR Part 26 and the State DOT's U.S. DOT-approved DBE program are incorporated by reference.
 - b. The contractor or subcontractor shall not discriminate on the basis of race, color, national origin, or sex in the performance of this contract. The contractor shall carry out applicable requirements of 49 CFR Part 26 in the award and administration of DOT-assisted contracts. Failure by the contractor to carry out these requirements is a material breach of this contract, which may result in the termination of this contract or such other remedy as the contracting agency deems appropriate.
11. **Records and Reports:** The contractor shall keep such records as necessary to document compliance with the EEO requirements. Such records shall be retained for a period of three years following the date of the final payment to the contractor for all contract work and shall be available at reasonable times and places for inspection by authorized representatives of the contracting agency and the FHWA.
- a. The records kept by the contractor shall document the following:
 - (1) The number and work hours of minority and non-minority group members and women employed in each work classification on the project;
 - (2) The progress and efforts being made in cooperation with unions, when applicable, to increase employment opportunities for minorities and women; and
 - (3) The progress and efforts being made in locating, hiring, training, qualifying, and upgrading minorities and women;
 - b. The contractors and subcontractors will submit an annual report to the contracting agency each July for the duration of the project, indicating the number of minority, women, and non-minority group employees currently engaged in each work classification required by the contract work. This information is to be reported on Form FHWA-1391. The staffing data should represent the project work force on board in all or any part of the last payroll period preceding the end of July. If on-the-job training is being required by special provision, the contractor will be required to collect and report training data. The employment data should reflect the work force on board during all or any part of the last payroll period preceding the end of July.

III. NONSEGREGATED FACILITIES

This provision is applicable to all Federal-aid construction contracts and to all related construction subcontracts of \$10,000 or more.

The contractor must ensure that facilities provided for employees are provided in such a manner that segregation on the basis of race, color, religion, sex, or national origin cannot result. The contractor may neither require such segregated use by written or oral policies nor tolerate such use by employee custom. The contractor's obligation extends further to ensure that its employees are not assigned to perform their services at any location, under the contractor's control, where the facilities are segregated. The term "facilities" includes waiting rooms, work areas, restaurants and other eating areas, time clocks, restrooms, washrooms, locker rooms, and other storage or dressing areas, parking lots, drinking fountains, recreation or entertainment areas, transportation, and housing provided for employees. The contractor shall provide separate or single-user restrooms and necessary dressing or sleeping areas to assure privacy between sexes.

IV. DAVIS-BACON AND RELATED ACT PROVISIONS

This section is applicable to all Federal-aid construction projects exceeding \$2,000 and to all related subcontracts and lower-tier subcontracts (regardless of subcontract size). The requirements apply to all projects located within the right-of-way of a roadway that is functionally classified as Federal-aid highway. This excludes roadways functionally classified as local roads or rural minor collectors, which are exempt. Contracting agencies may elect to apply these requirements to other projects.

The following provisions are from the U.S. Department of Labor regulations in 29 CFR 5.5 "Contract provisions and related matters" with minor revisions to conform to the FHWA-1273 format and FHWA program requirements.

1. Minimum wages

- a. All laborers and mechanics employed or working upon the site of the work, will be paid unconditionally and not less often than once a week, and without subsequent deduction or rebate on any account (except such payroll deductions as are permitted by regulations issued by the Secretary of Labor under the Copeland Act (29 CFR part 3)), the full amount of wages and bona fide fringe benefits (or cash equivalents thereof) due at time of payment computed at rates not less than those contained in the wage determination of the Secretary of Labor which is attached hereto and made a part hereof, regardless of any contractual relationship which may be alleged to exist between the contractor and such laborers and mechanics.

Contributions made or costs reasonably anticipated for bona fide fringe benefits under section 1(b)(2) of the Davis-Bacon Act on behalf of laborers or mechanics are considered wages paid to such laborers or mechanics, subject to the provisions of paragraph 1.d. of this section; also, regular contributions made or costs incurred for more than a weekly period (but not less often than quarterly) under plans, funds, or programs which cover the particular weekly period, are deemed to be constructively made or incurred during such weekly period. Such laborers and mechanics shall be paid the appropriate wage rate and fringe benefits on the wage determination for the classification of work actually performed, without regard to skill, except as provided in 29 CFR 5.5(a)(4). Laborers or mechanics performing work in more than one classification may be compensated at the rate specified for each classification for the time actually worked therein: Provided, That the employer's payroll records accurately set forth the time spent in each classification in which work is performed. The wage determination (including any additional classification and wage rates conformed under paragraph 1.b. of this section) and the Davis-Bacon poster (WH-1321) shall be posted at all times by the contractor and its subcontractors at the site of the work in a prominent and accessible place where it can be easily seen by the workers.

- b. (1) The contracting officer shall require that any class of laborers or mechanics, including helpers, which is not listed in the wage determination and which is to be employed under the contract shall be classified in conformance with the wage determination. The contracting officer shall approve an additional classification and wage rate and fringe benefits therefore only when the following criteria have been met:
- (i) The work to be performed by the classification requested is not performed by a classification in the wage determination; and
 - (ii) The classification is utilized in the area by the construction industry; and
 - (iii) The proposed wage rate, including any bona fide fringe benefits, bears a reasonable relationship to the wage rates contained in the wage determination.
- (2) If the contractor and the laborers and mechanics to be employed in the classification (if known), or their representatives, and the contracting officer agree on the classification and wage rate (including the amount designated for fringe benefits where appropriate), a report of the action taken shall be sent by the contracting officer to the Administrator of the Wage and Hour Division, Employment Standards Administration, U.S. Department of Labor, Washington, DC 20210. The Administrator, or an authorized representative, will approve, modify, or disapprove every additional classification action within 30 days of receipt and so advise the contracting officer or will notify the contracting officer within the 30-day period that additional time is necessary.
- (3) In the event the contractor, the laborers or mechanics to be employed in the classification or their representatives, and the contracting officer do not agree on the proposed classification and wage rate (including the amount designated for fringe benefits, where appropriate), the contracting officer shall refer the questions, including the views of all interested parties and the recommendation of the contracting officer, to the Wage and Hour Administrator for determination. The Wage and Hour Administrator, or an authorized representative, will issue a determination within 30 days of receipt and so advise the contracting officer or will notify the contracting officer within the 30-day period that additional time is necessary.
- (4) The wage rate (including fringe benefits where appropriate) determined pursuant to paragraphs 1.b.(2) or 1.b.(3) of this section, shall be paid to all workers performing work in the classification under this contract from the first day on which work is performed in the classification.
- c. Whenever the minimum wage rate prescribed in the contract for a class of laborers or mechanics includes a fringe benefit which is not expressed as an hourly rate, the contractor shall either pay the benefit as stated in the wage determination or shall pay another bona fide fringe benefit or an hourly cash equivalent thereof.
- d. If the contractor does not make payments to a trustee or other third person, the contractor may consider as part of the wages of any laborer or mechanic the amount of any costs reasonably anticipated in providing bona fide fringe benefits under a plan or program, Provided, That the Secretary of Labor has found, upon the written request of the contractor, that the applicable standards of the Davis-Bacon Act have been met. The Secretary of Labor may require the contractor to set aside in a separate account assets for the meeting of obligations under the plan or program.
2. **Withholding.** The contracting agency shall upon its own action or upon written request of an authorized representative of the Department of Labor, withhold or cause to be withheld from the contractor under this contract, or any other Federal contract with the same prime contractor, or any other federally-assisted contract subject to Davis-Bacon prevailing wage requirements, which is held by the same prime contractor, so much of the accrued payments or advances as may be considered necessary to pay laborers and mechanics, including apprentices, trainees, and helpers, employed by the contractor or any subcontractor the full amount of wages required by the contract. In the event of failure to pay any laborer or mechanic, including any apprentice, trainee, or helper, employed or working on the site of the work, all or part of the wages required by the contract, the contracting agency may, after written notice to the contractor, take such action as may be necessary to cause the suspension of any further payment, advance, or guarantee of funds until such violations have ceased.
3. **Payrolls and basic records**
- a. Payrolls and basic records relating thereto shall be maintained by the contractor during the course of the work and preserved for a period of three years thereafter for all laborers and mechanics working at the site of the work. Such records shall contain the name, address, and social security number of each such worker, his or her correct classification, hourly rates of wages paid (including rates of contributions or costs anticipated for bona fide fringe benefits or cash equivalents thereof of the types described in section 1(b)(2)(B) of the Davis-Bacon Act), daily and weekly number of hours worked, deductions made and actual wages paid. Whenever the Secretary of Labor has found under 29 CFR 5.5(a)(1)(iv) that the wages of any laborer or mechanic include the amount of any costs reasonably anticipated in providing benefits under a plan or program described in section 1(b)(2)(B) of the Davis-Bacon Act, the contractor shall maintain records which show that the commitment to provide such benefits is enforceable, that the plan or program is financially responsible, and that the plan or program has been communicated in writing to the laborers or mechanics affected, and records which show the costs anticipated or the actual cost incurred in providing such benefits. Contractors employing apprentices or trainees under approved programs shall maintain written evidence of the registration of apprenticeship programs and certification of trainee programs, the registration of the apprentices and trainees, and the ratios and wage rates prescribed in the applicable programs.
- b. (1) The contractor shall submit weekly for each week in which any contract work is performed a copy of all payrolls to the contracting agency. The payrolls submitted shall set out accurately and completely all of the information required to be maintained under

29 CFR 5.5(a)(3)(i), except that full social security numbers and home addresses shall not be included on weekly transmittals. Instead the payrolls shall only need to include an individually identifying number for each employee (e.g., the last four digits of the employee's social security number). The required weekly payroll information may be submitted in any form desired. Optional Form WH-347 is available for this purpose from the Wage and Hour Division Web site at <http://www.dol.gov/esa/whd/forms/wh347instr.htm> or its successor site. The prime contractor is responsible for the submission of copies of payrolls by all subcontractors. Contractors and subcontractors shall maintain the full social security number and current address of each covered worker, and shall provide them upon request to the contracting agency for transmission to the State DOT, the FHWA or the Wage and Hour Division of the Department of Labor for purposes of an investigation or audit of compliance with prevailing wage requirements. It is not a violation of this section for a prime contractor to require a subcontractor to provide addresses and social security numbers to the prime contractor for its own records, without weekly submission to the contracting agency.

- (2) Each payroll submitted shall be accompanied by a "Statement of Compliance," signed by the contractor or subcontractor or his or her agent who pays or supervises the payment of the persons employed under the contract and shall certify the following:
 - (i) That the payroll for the payroll period contains the information required to be provided under §5.5 (a)(3)(ii) of Regulations, 29 CFR part 5, the appropriate information is being maintained under §5.5 (a)(3)(i) of Regulations, 29 CFR part 5, and that such information is correct and complete;
 - (ii) That each laborer or mechanic (including each helper, apprentice, and trainee) employed on the contract during the payroll period has been paid the full weekly wages earned, without rebate, either directly or indirectly, and that no deductions have been made either directly or indirectly from the full wages earned, other than permissible deductions as set forth in Regulations, 29 CFR part 3;
 - (iii) That each laborer or mechanic has been paid not less than the applicable wage rates and fringe benefits or cash equivalents for the classification of work performed, as specified in the applicable wage determination incorporated into the contract.
 - (3) The weekly submission of a properly executed certification set forth on the reverse side of Optional Form WH-347 shall satisfy the requirement for submission of the "Statement of Compliance" required by paragraph 3.b.(2) of this section.
 - (4) The falsification of any of the above certifications may subject the contractor or subcontractor to civil or criminal prosecution under section 1001 of title 18 and section 231 of title 31 of the United States Code.
- c. The contractor or subcontractor shall make the records required under paragraph 3.a. of this section available for inspection, copying, or transcription by authorized representatives of the contracting agency, the State DOT, the FHWA, or the Department of Labor, and shall permit such representatives to interview employees during working hours on the job. If the contractor or subcontractor fails to submit the required records or to make them available, the FHWA may, after written notice to the contractor, the contracting agency or the State DOT, take such action as may be necessary to cause the suspension of any further payment, advance, or guarantee of funds. Furthermore, failure to submit the required records upon request or to make such records available may be grounds for debarment action pursuant to 29 CFR 5.12.

4. Apprentices and trainees

- a. Apprentices (programs of the USDOL). Apprentices will be permitted to work at less than the predetermined rate for the work they performed when they are employed pursuant to and individually registered in a bona fide apprenticeship program registered with the U.S. Department of Labor, Employment and Training Administration, Office of Apprenticeship Training, Employer and Labor Services, or with a State Apprenticeship Agency recognized by the Office, or if a person is employed in his or her first 90 days of probationary employment as an apprentice in such an apprenticeship program, who is not individually registered in the program, but who has been certified by the Office of Apprenticeship Training, Employer and Labor Services or a State Apprenticeship Agency (where appropriate) to be eligible for probationary employment as an apprentice.

The allowable ratio of apprentices to journeymen on the job site in any craft classification shall not be greater than the ratio permitted to the contractor as to the entire work force under the registered program. Any worker listed on a payroll at an apprentice wage rate, who is not registered or otherwise employed as stated above, shall be paid not less than the applicable wage rate on the wage determination for the classification of work actually performed. In addition, any apprentice performing work on the job site in excess of the ratio permitted under the registered program shall be paid not less than the applicable wage rate on the wage determination for the work actually performed. Where a contractor is performing construction on a project in a locality other than that in which its program is registered, the ratios and wage rates (expressed in percentages of the journeyman's hourly rate) specified in the contractor's or subcontractor's registered program shall be observed.

Every apprentice must be paid at not less than the rate specified in the registered program for the apprentice's level of progress, expressed as a percentage of the journeymen hourly rate specified in the applicable wage determination. Apprentices shall be paid fringe benefits in accordance with the provisions of the apprenticeship program. If the apprenticeship program does not specify fringe benefits, apprentices must be paid the full amount of fringe benefits listed on the wage determination for the applicable classification. If the Administrator determines that a different practice prevails for the applicable apprentice classification, fringes shall be paid in accordance with that determination.

In the event the Office of Apprenticeship Training, Employer and Labor Services, or a State Apprenticeship Agency recognized by the Office, withdraws approval of an apprenticeship program, the contractor will no longer be permitted to utilize apprentices at less than the applicable predetermined rate for the work performed until an acceptable program is approved.

- b. Trainees (programs of the USDOL). Except as provided in 29 CFR 5.16, trainees will not be permitted to work at less than the predetermined rate for the work performed unless they are employed pursuant to and individually registered in a program which has received prior approval, evidenced by formal certification by the U.S. Department of Labor, Employment and Training Administration.

The ratio of trainees to journeymen on the job site shall not be greater than permitted under the plan approved by the Employment and Training Administration.

Every trainee must be paid at not less than the rate specified in the approved program for the trainee's level of progress, expressed as a percentage of the journeyman hourly rate specified in the applicable wage determination. Trainees shall be paid fringe benefits in accordance with the provisions of the trainee program. If the trainee program does not mention fringe benefits, trainees shall be paid the full amount of fringe benefits listed on the wage determination unless the Administrator of the Wage and Hour Division determines that there is an apprenticeship program associated with the corresponding journeyman wage rate on the wage determination which provides for less than full fringe benefits for apprentices. Any employee listed on the payroll at a trainee rate who is not registered and participating in a training plan approved by the Employment and Training Administration shall be paid not less than the applicable wage rate on the wage determination for the classification of work actually performed. In addition, any trainee performing work on the job site in excess of the ratio permitted under the registered program shall be paid not less than the applicable wage rate on the wage determination for the work actually performed.

In the event the Employment and Training Administration withdraws approval of a training program, the contractor will no longer be permitted to utilize trainees at less than the applicable predetermined rate for the work performed until an acceptable program is approved.

- c. Equal employment opportunity. The utilization of apprentices, trainees and journeymen under this part shall be in conformity with the equal employment opportunity requirements of Executive Order 11246, as amended, and 29 CFR part 30.
 - d. Apprentices and Trainees (programs of the U.S. DOT). Apprentices and trainees working under apprenticeship and skill training programs which have been certified by the Secretary of Transportation as promoting EEO in connection with Federal-aid highway construction programs are not subject to the requirements of paragraph 4 of this Section IV. The straight time hourly wage rates for apprentices and trainees under such programs will be established by the particular programs. The ratio of apprentices and trainees to journeymen shall not be greater than permitted by the terms of the particular program.
5. **Compliance with Copeland Act requirements.** The contractor shall comply with the requirements of 29 CFR part 3, which are incorporated by reference in this contract.
 6. **Subcontracts.** The contractor or subcontractor shall insert Form FHWA-1273 in any subcontracts and also require the subcontractors to include Form FHWA-1273 in any lower tier subcontracts. The prime contractor shall be responsible for the compliance by any subcontractor or lower tier subcontractor with all the contract clauses in 29 CFR 5.5.
 7. **Contract termination:** debarment. A breach of the contract clauses in 29 CFR 5.5 may be grounds for termination of the contract, and for debarment as a contractor and a subcontractor as provided in 29 CFR 5.12.
 8. **Compliance with Davis-Bacon and Related Act requirements.** All rulings and interpretations of the Davis-Bacon and Related Acts contained in 29 CFR parts 1, 3, and 5 are herein incorporated by reference in this contract.
 9. **Disputes concerning labor standards.** Disputes arising out of the labor standards provisions of this contract shall not be subject to the general disputes clause of this contract. Such disputes shall be resolved in accordance with the procedures of the Department of Labor set forth in 29 CFR parts 5, 6, and 7. Disputes within the meaning of this clause include disputes between the contractor (or any of its subcontractors) and the contracting agency, the U.S. Department of Labor, or the employees or their representatives.
 10. **Certification of eligibility.**
 - a. By entering into this contract, the contractor certifies that neither it (nor he or she) nor any person or firm who has an interest in the contractor's firm is a person or firm ineligible to be awarded Government contracts by virtue of section 3(a) of the Davis-Bacon Act or 29 CFR 5.12(a)(1).
 - b. No part of this contract shall be subcontracted to any person or firm ineligible for award of a Government contract by virtue of section 3(a) of the Davis-Bacon Act or 29 CFR 5.12(a)(1).
 - c. The penalty for making false statements is prescribed in the U.S. Criminal Code, 18 U.S.C. 1001.

V. CONTRACT WORK HOURS AND SAFETY STANDARDS ACT

The following clauses apply to any Federal-aid construction contract in an amount in excess of \$100,000 and subject to the overtime provisions of the Contract Work Hours and Safety Standards Act. These clauses shall be inserted in addition to the clauses required by 29 CFR 5.5(a) or 29 CFR 4.6. As used in this paragraph, the terms laborers and mechanics include watchmen and guards.

1. **Overtime requirements.** No contractor or subcontractor contracting for any part of the contract work which may require or involve the employment of laborers or mechanics shall require or permit any such laborer or mechanic in any workweek in which he or she is employed on such work to work in excess of forty hours in such workweek unless such laborer or mechanic receives compensation at a rate not less than one and one-half times the basic rate of pay for all hours worked in excess of forty hours in such workweek.
2. **Violation; liability for unpaid wages; liquidated damages.** In the event of any violation of the clause set forth in paragraph (1.) of this section, the contractor and any subcontractor responsible therefor shall be liable for the unpaid wages. In addition, such contractor and subcontractor shall be liable to the United States (in the case of work done under contract for the District of Columbia or a territory, to such District or to such territory), for liquidated damages. Such liquidated damages shall be computed with respect to each individual laborer or mechanic, including watchmen and guards, employed in violation of the clause set forth in paragraph (1.) of this section, in the sum of \$10 for each calendar day on which such individual was required or permitted to work in excess of the standard workweek of forty hours without payment of the overtime wages required by the clause set forth in paragraph (1.) of this section.
3. **Withholding for unpaid wages and liquidated damages.** The FHWA or the contacting agency shall upon its own action or upon written request of an authorized representative of the Department of Labor withhold or cause to be withheld, from any moneys payable on account of work performed by the contractor or subcontractor under any such contract or any other Federal contract with the same prime contractor, or any other federally-assisted contract subject to the Contract Work Hours and Safety Standards Act, which is held by the same prime contractor, such sums as may be determined to be necessary to satisfy any liabilities of such contractor or subcontractor for unpaid wages and liquidated damages as provided in the clause set forth in paragraph (2.) of this section.
4. **Subcontracts.** The contractor or subcontractor shall insert in any subcontracts the clauses set forth in paragraph (1.) through (4.) of this section and also a clause requiring the subcontractors to include these clauses in any lower tier subcontracts. The prime contractor shall be responsible for compliance by any subcontractor or lower tier subcontractor with the clauses set forth in paragraphs (1.) through (4.) of this section.

VI. SUBLETTING OR ASSIGNING THE CONTRACT

This provision is applicable to all Federal-aid construction contracts on the National Highway System.

1. The contractor shall perform with its own organization contract work amounting to not less than 30 percent (or a greater percentage if specified elsewhere in the contract) of the total original contract price, excluding any specialty items designated by the contracting agency. Specialty items may be performed by subcontract and the amount of any such specialty items performed may be deducted from the total original contract price before computing the amount of work required to be performed by the contractor's own organization (23 CFR 635.116).
 - a. The term "perform work with its own organization" refers to workers employed or leased by the prime contractor, and equipment owned or rented by the prime contractor, with or without operators. Such term does not include employees or equipment of a subcontractor or lower tier subcontractor, agents of the prime contractor, or any other assignees. The term may include payments for the costs of hiring leased employees from an employee leasing firm meeting all relevant Federal and State regulatory requirements. Leased employees may only be included in this term if the prime contractor meets all of the following conditions:
 - (1) the prime contractor maintains control over the supervision of the day-to-day activities of the leased employees;
 - (2) the prime contractor remains responsible for the quality of the work of the leased employees;
 - (3) the prime contractor retains all power to accept or exclude individual employees from work on the project; and

- (4) the prime contractor remains ultimately responsible for the payment of predetermined minimum wages, the submission of payrolls, statements of compliance and all other Federal regulatory requirements.
- b. "Specialty Items" shall be construed to be limited to work that requires highly specialized knowledge, abilities, or equipment not ordinarily available in the type of contracting organizations qualified and expected to bid or propose on the contract as a whole and in general are to be limited to minor components of the overall contract.
2. The contract amount upon which the requirements set forth in paragraph (1) of Section VI is computed includes the cost of material and manufactured products which are to be purchased or produced by the contractor under the contract provisions.
 3. The contractor shall furnish (a) a competent superintendent or supervisor who is employed by the firm, has full authority to direct performance of the work in accordance with the contract requirements, and is in charge of all construction operations (regardless of who performs the work) and (b) such other of its own organizational resources (supervision, management, and engineering services) as the contracting officer determines is necessary to assure the performance of the contract.
 4. No portion of the contract shall be sublet, assigned or otherwise disposed of except with the written consent of the contracting officer, or authorized representative, and such consent when given shall not be construed to relieve the contractor of any responsibility for the fulfillment of the contract. Written consent will be given only after the contracting agency has assured that each subcontract is evidenced in writing and that it contains all pertinent provisions and requirements of the prime contract.
 5. The 30% self-performance requirement of paragraph (1) is not applicable to design-build contracts; however, contracting agencies may establish their own self-performance requirements.

VII. SAFETY: ACCIDENT PREVENTION

This provision is applicable to all Federal-aid construction contracts and to all related subcontracts.

1. In the performance of this contract the contractor shall comply with all applicable Federal, State, and local laws governing safety, health, and sanitation (23 CFR 635). The contractor shall provide all safeguards, safety devices and protective equipment and take any other needed actions as it determines, or as the contracting officer may determine, to be reasonably necessary to protect the life and health of employees on the job and the safety of the public and to protect property in connection with the performance of the work covered by the contract.
2. It is a condition of this contract, and shall be made a condition of each subcontract, which the contractor enters into pursuant to this contract, that the contractor and any subcontractor shall not permit any employee, in performance of the contract, to work in surroundings or under conditions which are unsanitary, hazardous or dangerous to his/her health or safety, as determined under construction safety and health standards (29 CFR 1926) promulgated by the Secretary of Labor, in accordance with Section 107 of the Contract Work Hours and Safety Standards Act (40 U.S.C. 3704).
3. Pursuant to 29 CFR 1926.3, it is a condition of this contract that the Secretary of Labor or authorized representative thereof, shall have right of entry to any site of contract performance to inspect or investigate the matter of compliance with the construction safety and health standards and to carry out the duties of the Secretary under Section 107 of the Contract Work Hours and Safety Standards Act (40 U.S.C.3704).

VIII. FALSE STATEMENTS CONCERNING HIGHWAY PROJECTS

This provision is applicable to all Federal-aid construction contracts and to all related subcontracts.

In order to assure high quality and durable construction in conformity with approved plans and specifications and a high degree of reliability on statements and representations made by engineers, contractors, suppliers, and workers on Federal-aid highway projects, it is essential that all persons concerned with the project perform their functions as carefully, thoroughly, and honestly as possible. Willful falsification, distortion, or misrepresentation with respect to any facts related to the project is a violation of Federal law. To prevent any misunderstanding regarding the seriousness of these and similar acts, Form FHWA-1022 shall be posted on each Federal-aid highway project (23 CFR 635) in one or more places where it is readily available to all persons concerned with the project:

18 U.S.C. 1020 reads as follows:

"Whoever, being an officer, agent, or employee of the United States, or of any State or Territory, or whoever, whether a person, association, firm, or corporation, knowingly makes any false statement, false representation, or false report as to the character, quality, quantity, or cost of the material used or to be used, or the quantity or quality of the work performed or to be performed, or the cost thereof in connection with the submission of plans, maps, specifications, contracts, or costs of construction on any highway or related project submitted for approval to the Secretary of Transportation; or

Whoever knowingly makes any false statement, false representation, false report or false claim with respect to the character, quality, quantity, or cost of any work performed or to be performed, or materials furnished or to be furnished, in connection with the construction of any highway or related project approved by the Secretary of Transportation; or

Whoever knowingly makes any false statement or false representation as to material fact in any statement, certificate, or report submitted pursuant to provisions of the Federal-aid Roads Act approved July 1, 1916, (39 Stat. 355), as amended and supplemented;

Shall be fined under this title or imprisoned not more than 5 years or both."

IX. IMPLEMENTATION OF CLEAN AIR ACT AND FEDERAL WATER POLLUTION CONTROL ACT

This provision is applicable to all Federal-aid construction contracts and to all related subcontracts.

By submission of this bid/proposal or the execution of this contract, or subcontract, as appropriate, the bidder, proposer, Federal-aid construction contractor, or subcontractor, as appropriate, will be deemed to have stipulated as follows:

1. That any person who is or will be utilized in the performance of this contract is not prohibited from receiving an award due to a violation of Section 508 of the Clean Water Act or Section 306 of the Clean Air Act.
2. That the contractor agrees to include or cause to be included the requirements of paragraph (1) of this Section X in every subcontract, and further agrees to take such action as the contracting agency may direct as a means of enforcing such requirements.

X. CERTIFICATION REGARDING DEBARMENT, SUSPENSION, INELIGIBILITY AND VOLUNTARY EXCLUSION

This provision is applicable to all Federal-aid construction contracts, design-build contracts, subcontracts, lower-tier subcontracts, purchase orders, lease agreements, consultant contracts or any other covered transaction requiring FHWA approval or that is estimated to cost \$25,000 or more – as defined in 2 CFR Parts 180 and 1200.

1. Instructions for Certification – First Tier Participants:

- a. By signing and submitting this proposal, the prospective first tier participant is providing the certification set out below.
- b. The inability of a person to provide the certification set out below will not necessarily result in denial of participation in this covered transaction. The prospective first tier participant shall submit an explanation of why it cannot provide the certification set out below. The certification or explanation will be considered in connection with the department or agency's determination whether to enter into this transaction. However, failure of the prospective first tier participant to furnish a certification or an explanation shall disqualify such a person from participation in this transaction.
- c. The certification in this clause is a material representation of fact upon which reliance was placed when the contracting agency determined to enter into this transaction. If it is later determined that the prospective participant knowingly rendered an erroneous certification, in addition to other remedies available to the Federal Government, the contracting agency may terminate this transaction for cause of default.
- d. The prospective first tier participant shall provide immediate written notice to the contracting agency to whom this proposal is submitted if any time the prospective first tier participant learns that its certification was erroneous when submitted or has become erroneous by reason of changed circumstances.
- e. The terms "covered transaction," "debarred," "suspended," "ineligible," "participant," "person," "principal," and "voluntarily excluded," as used in this clause, are defined in 2 CFR Parts 180 and 1200. "First Tier Covered Transactions" refers to any covered transaction between a grantee or subgrantee of Federal funds and a participant (such as the prime or general contract). "Lower Tier Covered Transactions" refers to any covered transaction under a First Tier Covered Transaction (such as subcontracts). "First Tier Participant" refers to the participant who has entered into a covered transaction with a grantee or subgrantee of Federal funds (such as the prime or general contractor). "Lower Tier Participant" refers any participant who has entered into a covered transaction with a First Tier Participant or other Lower Tier Participants (such as subcontractors and suppliers).
- f. The prospective first tier participant agrees by submitting this proposal that, should the proposed covered transaction be entered into, it shall not knowingly enter into any lower tier covered transaction with a person who is debarred, suspended, declared ineligible, or voluntarily excluded from participation in this covered transaction, unless authorized by the department or agency entering into this transaction.
- g. The prospective first tier participant further agrees by submitting this proposal that it will include the clause titled "Certification Regarding Debarment, Suspension, Ineligibility and Voluntary Exclusion-Lower Tier Covered Transactions," provided by the department or contracting agency, entering into this covered transaction, without modification, in all lower tier covered transactions and in all solicitations for lower tier covered transactions exceeding the \$25,000 threshold.
- h. A participant in a covered transaction may rely upon a certification of a prospective participant in a lower tier covered transaction that is not debarred, suspended, ineligible, or voluntarily excluded from the covered transaction, unless it knows that the certification is erroneous. A participant is responsible for ensuring that its principals are not suspended, debarred, or otherwise ineligible to participate in covered transactions. To verify the eligibility of its principals, as well as the eligibility of any lower tier prospective participants, each participant may, but is not required to, check the Excluded Parties List System website (<https://www.epls.gov/>), which is compiled by the General Services Administration.
- i. Nothing contained in the foregoing shall be construed to require the establishment of a system of records in order to render in good faith the certification required by this clause. The knowledge and information of the prospective participant is not required to exceed that which is normally possessed by a prudent person in the ordinary course of business dealings.
- j. Except for transactions authorized under paragraph (f) of these instructions, if a participant in a covered transaction knowingly enters into a lower tier covered transaction with a person who is suspended, debarred, ineligible, or voluntarily excluded from participation in this transaction, in addition to other remedies available to the Federal Government, the department or agency may terminate this transaction for cause or default.

* * * * *

2. Certification Regarding Debarment, Suspension, Ineligibility and Voluntary Exclusion – First Tier Participants:

- a. The prospective first tier participant certifies to the best of its knowledge and belief, that it and its principals:
 - (1) Are not presently debarred, suspended, proposed for debarment, declared ineligible, or voluntarily excluded from participating in covered transactions by any Federal department or agency;
 - (2) Have not within a three-year period preceding this proposal been convicted of or had a civil judgment rendered against them for commission of fraud or a criminal offense in connection with obtaining, attempting to obtain, or performing a public (Federal, State or local) transaction or contract under a public transaction; violation of Federal or State antitrust statutes or commission of embezzlement, theft, forgery, bribery, falsification or destruction of records, making false statements, or receiving stolen property;
 - (3) Are not presently indicted for or otherwise criminally or civilly charged by a governmental entity (Federal, State or local) with commission of any of the offenses enumerated in paragraph (a)(2) of this certification; and
 - (4) Have not within a three-year period preceding this application/proposal had one or more public transactions (Federal, State or local) terminated for cause or default.
- b. Where the prospective participant is unable to certify to any of the statements in this certification, such prospective participant shall attach an explanation to this proposal.

2. Instructions for Certification - Lower Tier Participants:

(Applicable to all subcontracts, purchase orders and other lower tier transactions requiring prior FHWA approval or estimated to cost \$25,000 or more - 2 CFR Parts 180 and 1200)

- a. By signing and submitting this proposal, the prospective lower tier is providing the certification set out below.
- b. The certification in this clause is a material representation of fact upon which reliance was placed when this transaction was entered into. If it is later determined that the prospective lower tier participant knowingly rendered an erroneous certification, in addition to other remedies available to the Federal Government, the department, or agency with which this transaction originated may pursue available remedies, including suspension and/or debarment.
- c. The prospective lower tier participant shall provide immediate written notice to the person to which this proposal is submitted if at any time the prospective lower tier participant learns that its certification was erroneous by reason of changed circumstances.
- d. The terms "covered transaction," "debarred," "suspended," "ineligible," "participant," "person," "principal," and "voluntarily excluded," as used in this clause, are defined in 2 CFR Parts 180 and 1200. You may contact the person to which this proposal is submitted for assistance in obtaining a copy of those regulations. "First Tier Covered Transactions" refers to any covered transaction between a grantee or subgrantee of

Federal funds and a participant (such as the prime or general contract). "Lower Tier Covered Transactions" refers to any covered transaction under a First Tier Covered Transaction (such as subcontracts). "First Tier Participant" refers to the participant who has entered into a covered transaction with a grantee or subgrantee of Federal funds (such as the prime or general contractor). "Lower Tier Participant" refers to any participant who has entered into a covered transaction with a First Tier Participant or other Lower Tier Participants (such as subcontractors and suppliers).

- e. The prospective lower tier participant agrees by submitting this proposal that, should the proposed covered transaction be entered into, it shall not knowingly enter into any lower tier covered transaction with a person who is debarred, suspended, declared ineligible, or voluntarily excluded from participation in this covered transaction, unless authorized by the department or agency with which this transaction originated.
- f. The prospective lower tier participant further agrees by submitting this proposal that it will include this clause titled "Certification Regarding Debarment, Suspension, Ineligibility and Voluntary Exclusion-Lower Tier Covered Transaction," without modification, in all lower tier covered transactions and in all solicitations for lower tier covered transactions exceeding the \$25,000 threshold.
- g. A participant in a covered transaction may rely upon a certification of a prospective participant in a lower tier covered transaction that is not debarred, suspended, ineligible, or voluntarily excluded from the covered transaction, unless it knows that the certification is erroneous. A participant is responsible for ensuring that its principals are not suspended, debarred, or otherwise ineligible to participate in covered transactions. To verify the eligibility of its principals, as well as the eligibility of any lower tier prospective participants, each participant may, but is not required to, check the Excluded Parties List System website (<https://www.epls.gov/>), which is compiled by the General Services Administration.
- h. Nothing contained in the foregoing shall be construed to require establishment of a system of records in order to render in good faith the certification required by this clause. The knowledge and information of participant is not required to exceed that which is normally possessed by a prudent person in the ordinary course of business dealings.
- i. Except for transactions authorized under paragraph e of these instructions, if a participant in a covered transaction knowingly enters into a lower tier covered transaction with a person who is suspended, debarred, ineligible, or voluntarily excluded from participation in this transaction, in addition to other remedies available to the Federal Government, the department or agency with which this transaction originated may pursue available remedies, including suspension and/or debarment.

* * * * *

Certification Regarding Debarment, Suspension, Ineligibility and Voluntary Exclusion--Lower Tier Participants:

1. The prospective lower tier participant certifies, by submission of this proposal, that neither it nor its principals is presently debarred, suspended, proposed for debarment, declared ineligible, or voluntarily excluded from participating in covered transactions by any Federal department or agency.
2. Where the prospective lower tier participant is unable to certify to any of the statements in this certification, such prospective participant shall attach an explanation to this proposal.

* * * * *

XI. CERTIFICATION REGARDING USE OF CONTRACT FUNDS FOR LOBBYING

This provision is applicable to all Federal-aid construction contracts and to all related subcontracts which exceed \$100,000 (49 CFR 20).

1. The prospective participant certifies, by signing and submitting this bid or proposal, to the best of his or her knowledge and belief, that:
 - a. No Federal appropriated funds have been paid or will be paid, by or on behalf of the undersigned, to any person for influencing or attempting to influence an officer or employee of any Federal agency, a Member of Congress, an officer or employee of Congress, or an employee of a Member of Congress in connection with the awarding of any Federal contract, the making of any Federal grant, the making of any Federal loan, the entering into of any cooperative agreement, and the extension, continuation, renewal, amendment, or modification of any Federal contract, grant, loan, or cooperative agreement.
 - b. If any funds other than Federal appropriated funds have been paid or will be paid to any person for influencing or attempting to influence an officer or employee of any Federal agency, a Member of Congress, an officer or employee of Congress, or an employee of a Member of Congress in connection with this Federal contract, grant, loan, or cooperative agreement, the undersigned shall complete and submit Standard Form-LLL, "Disclosure Form to Report Lobbying," in accordance with its instructions.
2. This certification is a material representation of fact upon which reliance was placed when this transaction was made or entered into. Submission of this certification is a prerequisite for making or entering into this transaction imposed by 31 U.S.C. 1352. Any person who fails to file the required certification shall be subject to a civil penalty of not less than \$10,000 and not more than \$100,000 for each such failure.
3. The prospective participant also agrees by submitting its bid or proposal that the participant shall require that the language of this certification be included in all lower tier subcontracts, which exceed \$100,000 and that all such recipients shall certify and disclose accordingly.

STANDARD SPECIAL PROVISION**ON-THE-JOB TRAINING**

(10-16-07) (Rev. 4-21-15)

Z-10

Description

The North Carolina Department of Transportation will administer a custom version of the Federal On-the-Job Training (OJT) Program, commonly referred to as the Alternate OJT Program. All contractors (existing and newcomers) will be automatically placed in the Alternate Program. Standard OJT requirements typically associated with individual projects will no longer be applied at the project level. Instead, these requirements will be applicable on an annual basis for each contractor administered by the OJT Program Manager.

On the Job Training shall meet the requirements of 23 CFR 230.107 (b), 23 USC – Section 140, this provision and the On-the-Job Training Program Manual.

The Alternate OJT Program will allow a contractor to train employees on Federal, State and privately funded projects located in North Carolina. However, priority shall be given to training employees on NCDOT Federal-Aid funded projects.

Minorities and Women

Developing, training and upgrading of minorities and women toward journeyman level status is a primary objective of this special training provision. Accordingly, the Contractor shall make every effort to enroll minority and women as trainees to the extent that such persons are available within a reasonable area of recruitment. This training commitment is not intended, and shall not be used, to discriminate against any applicant for training, whether a member of a minority group or not.

Assigning Training Goals

The Department, through the OJT Program Manager, will assign training goals for a calendar year based on the contractors' past three years' activity and the contractors' anticipated upcoming year's activity with the Department. At the beginning of each year, all contractors eligible will be contacted by the Department to determine the number of trainees that will be assigned for the upcoming calendar year. At that time the Contractor shall enter into an agreement with the Department to provide a self-imposed on-the-job training program for the calendar year. This agreement will include a specific number of annual training goals agreed to by both parties. The number of training assignments may range from 1 to 15 per contractor per calendar year. The Contractor shall sign an agreement to fulfill their annual goal for the year.\

Training Classifications

The Contractor shall provide on-the-job training aimed at developing full journeyman level workers in the construction craft/operator positions. Preference shall be given to providing training in the following skilled work classifications:

Equipment Operators	Office Engineers
Truck Drivers	Estimators
Carpenters	Iron / Reinforcing Steel Workers
Concrete Finishers	Mechanics
Pipe Layers	Welders

The Department has established common training classifications and their respective training requirements that may be used by the contractors. However, the classifications established are not all-inclusive. Where the training is oriented toward construction applications, training will be allowed in lower-level management positions such as office engineers and estimators. Contractors shall submit new classifications for specific job functions that their employees are performing. The Department will review and recommend for acceptance to FHWA the new classifications proposed by contractors, if applicable. New classifications shall meet the following requirements:

Proposed training classifications are reasonable and realistic based on the job skill classification needs, and

The number of training hours specified in the training classification is consistent with common practices and provides enough time for the trainee to obtain journeyman level status.

The Contractor may allow trainees to be trained by a subcontractor provided that the Contractor retains primary responsibility for meeting the training and this provision is made applicable to the subcontract. However, only the Contractor will receive credit towards the annual goal for the trainee.

Where feasible, 25 percent of apprentices or trainees in each occupation shall be in their first year of apprenticeship or training. The number of trainees shall be distributed among the work classifications on the basis of the contractor's needs and the availability of journeymen in the various classifications within a reasonable area of recruitment.

No employee shall be employed as a trainee in any classification in which they have successfully completed a training course leading to journeyman level status or in which they have been employed as a journeyman.

Records and Reports

The Contractor shall maintain enrollment, monthly and completion reports documenting company compliance under these contract documents. These documents and any other information as requested shall be submitted to the OJT Program Manager.

Upon completion and graduation of the program, the Contractor shall provide each trainee with a certification Certificate showing the type and length of training satisfactorily completed.

Trainee Interviews

All trainees enrolled in the program will receive an initial and Trainee/Post graduate interview conducted by the OJT program staff.

Trainee Wages

Contractors shall compensate trainees on a graduating pay scale based upon a percentage of the prevailing minimum journeyman wages (Davis-Bacon Act). Minimum pay shall be as follows:

60 percent	of the journeyman wage for the first half of the training period
75 percent	of the journeyman wage for the third quarter of the training period
90 percent	of the journeyman wage for the last quarter of the training period

In no instance shall a trainee be paid less than the local minimum wage. The Contractor shall adhere to the minimum hourly wage rate that will satisfy both the NC Department of Labor (NCDOL) and the Department.

Achieving or Failing to Meet Training Goals

The Contractor will be credited for each trainee employed by him on the contract work who is currently enrolled or becomes enrolled in an approved program and who receives training for at least 50 percent of the specific program requirement. Trainees will be allowed to be transferred between projects if required by the Contractor's scheduled workload to meet training goals.

If a contractor fails to attain their training assignments for the calendar year, they may be taken off the NCDOT's Bidders List.

Measurement and Payment

No compensation will be made for providing required training in accordance with these contract documents.

STANDARD SPECIAL PROVISION
MINIMUM WAGES
GENERAL DECISION NC190090 01/04/2019 NC90

Z-090

Date: January 4, 2019

General Decision Number: NC190090 01/04/2019 NC90

Superseded General Decision Numbers: NC20180103

State: North Carolina

Construction Type: HIGHWAY

COUNTIES:

Brunswick	Greene	Onslow
Cumberland	Hoke	Pender
Currituck	Johnston	Pitt
Edgecombe	Nash	Wake
Franklin	New Hanover	Wayne

HIGHWAY CONSTRUCTION PROJECTS (excluding tunnels, building structures in rest area projects & railroad construction; bascule, suspension & spandrel arch bridges designed for commercial navigation, bridges involving marine construction; and other major bridges).

Note: Under Executive Order (EO) 13658, an hourly minimum wage of \$10.60 for calendar year 2019 that applies to all contracts subject to the Davis-Bacon Act for which the contract is awarded (and any solicitation was issued) on or after January 1, 2015. If this contract is covered by the EO, the contractor must pay all workers in any classification listed on this wage determination at least \$10.60 per hour (or the applicable wage rate listed on this wage determination, if it is higher) for all hours spent performing on the contract for calendar year 2019. If this contract is covered by the EO and a classification considered necessary for performance of work on the contract must pay workers in that classification at least the wage rate determined through the conformance process set forth in 29 CFR.5.5(a)(1)(ii) (or the EO minimum wage rate, if it is higher than the conformed wage rate). The EO minimum wage rate will be adjusted annually. Please note that this EO applies to the above-mentioned types of contracts entered into by the federal government that are subject to the Davis-Bacon Act itself, but it does not apply to contracts subject only to the Davis-Bacon Related Acts, including those set forth at 29 CFR 5.1(a)(2) – (60). Additional information on contractor requirements and worker protections under the EO is available at www.dol.gov/whd/govcontracts.

Modification Number

0

Publication Date

01/04/2019

SUNC2014-005 11/17/2014

	Rates	Fringes
BLASTER	21.04	
CARPENTER	13.72	
CEMENT MASON/CONCRETE FINISHER	14.48	
ELECTRICIAN		

	Rates	Fringes
Electrician	17.97	
Telecommunications Technician	16.79	.63
IRONWORKER	16.02	
LABORER		
Asphalt Raker and Spreader	12.46	
Asphalt Screed/Jackman	14.33	
Carpenter Tender	12.88	
Cement Mason/Concrete Finisher Tender	12.54	
Common or General	10.20	
Guardrail/Fence Installer	12.87	
Pipelayer	12.17	
Traffic Signal/Lighting Installer	14.89	
PAINTER		
Bridge	24.57	
POWER EQUIPMENT OPERATORS		
Asphalt Broom Tractor	11.85	
Bulldozer Fine	17.04	
Bulldozer Rough	14.34	
Concrete Grinder/Groover	20.34	2.30
Crane Boom Trucks	20.54	
Crane Other	20.08	
Crane Rough/All-Terrain	20.67	
Drill Operator Rock	14.38	
Drill Operator Structure	21.14	
Excavator Fine	16.60	
Excavator Rough	14.00	
Grader/Blade Fine	18.47	
Grader/Blade Rough	14.62	
Loader 2 Cubic Yards or Less	13.76	
Loader Greater Than 2 Cubic Yards	14.14	
Material Transfer Vehicle (Shuttle Buggy)	15.18	
Mechanic	17.55	
Milling Machine	15.36	
Off-Road Hauler/Water Tanker	11.36	
Oiler/Greaser	13.55	
Pavement Marking Equipment	12.11	
Paver Asphalt	15.59	
Paver Concrete	18.20	
Roller Asphalt Breakdown	12.45	
Roller Asphalt Finish	13.85	
Roller Other	11.36	
Scraper Finish	12.71	
Scraper Rough	11.35	
Slip Form Machine	16.50	
Tack Truck/Distributor Operator	14.52	
TRUCK DRIVER		
GVWR of 26,000 Lbs or Less	11.12	
GVWR of 26,000 Lbs or Greater	12.37	

Welders – Receive rate prescribed for craft performing operation to which welding is incidental.

Note: Executive Order (EO) 13706, Establishing Paid Sick Leave for Federal Contractors applies to all contracts subject to the Davis-Bacon Act for which the contract is awarded (and any solicitation was issued) on or after January 1, 2017. If this contract is covered by the EO, the contractor must provide employees with 1 hour of paid sick leave for every 30 hours they work, up to 56 hours of paid sick leave each year. Employees must be permitted to use paid sick leave for their own illness, injury or other health-related needs, including preventive care; to assist a family member (or person who is like family to the employee) who is ill, injured, or has other health-related needs, including preventive care; or for reasons resulting from, or to assist a family member (or person who is like family to the employee) who is a victim of, domestic violence, sexual assault, or stalking. Additional information on contractor requirements and worker protections under the EO is available at www.dol.gov/whd/govcontracts.

Unlisted classifications needed for work not included within the scope of the classifications listed may be added after award only as provided in the labor standards contract clauses (29 CFR 5.5(a)(1)(ii)).

The body of each wage determination lists the classification and wage rates that have been found to be prevailing for the cited type(s) of construction in the area covered by the wage determination. The classifications are listed in alphabetical order of "identifiers" that indicate whether the particular rate is a union rate (current union negotiated rate for local), a survey rate (weighted average rate) or a union average rate (weighted union average rate).

Union Rate Identifiers

A four letter classification abbreviation identifier enclosed in dotted lines beginning with characters other than "SU" or "UAVG" denotes that the union classification and rate were prevailing for that classification in the survey. Example: PLUM0198-005 07/01/2014. PLUM is an abbreviation identifier of the union which prevailed in the survey for this classification, which in this example would be Plumbers. 0198 indicates the local union number or district council number where applicable, i.e., Plumbers Local 0198. The next number, 005 in the example, is an internal number used in processing the wage determination. 07/01/2014 is the effective date of the most current negotiated rate, which in this example is July 1, 2014.

Union prevailing wage rates are updated to reflect all rate changes in the collective bargaining agreement (CBA) governing this classification and rate.

Survey Rate Identifiers

Classifications listed under the "SU" identifier indicate that no one rate prevailed for this classification in the survey and the published rate is derived by computing a weighted average rate based on all the rates reported in the survey for that classification. As this weighted average rate includes all rates reported in the survey, it may include both union and non-union rates. Example: SULA2012-007 5/13/2014. SU indicates the rates are survey rates based on a weighted average calculation of rates and are not majority rates. LA indicates the State of Louisiana. 2012 is the year of survey on which these classifications and rates are based. The next number, 007 in the example, is an internal number used in producing the wage determination. 5/13/2014 indicates the survey completion date for the classifications and rates under that identifier. Survey wage rates are not updated and remain in effect until a new survey is conducted.

Union Average Rate Identifiers

Classification(s) listed under the UAVG identifier indicate that no single majority rate prevailed for those classifications; however, 100% of the data reported for the classifications was union data. EXAMPLE: UAVG-OH-0010 08/29/2014. UAVG indicates that the rate is a weighted union average rate. OH indicates the state. The next number, 0010 in the example, is an internal number used in producing the wage determination. 08/29/2014 indicates the survey completion date for the classifications and rates under that identifier.

A UAVG rate will be updated once a year, usually in January of each year, to reflect a weighted average of the current negotiated/CBA rate of the union locals from which the rate is based.

WAGE DETERMINATION APPEALS PROCESS

1.) Has there been an initial decision in the matter? This can be:

- * an existing published wage determination
- * a survey underlying a wage determination
- * a Wage and Hour Division letter setting forth a position on a wage determination matter
- * a conformance (additional classification and rate) ruling

On survey related matters, initial contact, including requests for summaries of surveys, should be with the Wage and Hour Regional Office for the area in which the survey was conducted because those Regional Offices have responsibility for the Davis-Bacon survey program. If the response from this initial contact is not satisfactory, then the process described in 2.) and 3.) should be followed.

With regard to any other matter not yet ripe for the formal process described here, initial contact should be with the Branch of Construction Wage Determinations. Write to:

Branch of Construction Wage Determinations
Wage and Hour Division
U. S. Department of Labor
200 Constitution Avenue, N.W.
Washington, D.C. 20210

2.) If the answer to the question in 1.) is yes, then an interested party (those affected by the action) can request review and reconsideration from the Wage and Hour Administrator (See 29 CFR Part 1.8 and 29 CFR Part 7). Write to:

Wage and Hour Administrator
U.S. Department of Labor
200 Constitution Avenue, N.W.
Washington, D.C. 20210

The request should be accompanied by a full statement of the interested party's position and by any information (wage payment data, project description, area practice material, etc.) that the requestor considers relevant to the issue.

3.) If the decision of the Administrator is not favorable, an interested party may appeal directly to the Administrative Review Board (formerly the Wage Appeals Board). Write to:

Administrative Review Board
U.S. Department of Labor
200 Constitution Avenue, N.W.
Washington, D.C. 20210

- 4.) All decisions by the Administrative Review Board are final.

END OF GENERAL DECISION

PROJECT SPECIAL PROVISION

(10-18-95) (Rev. 3-21-17)

Z-1

PERMITS

The Contractor's attention is directed to the following permits, which have been issued to the Department of Transportation by the authority granting the permit.

<u>PERMIT</u>	<u>AUTHORITY GRANTING THE PERMIT</u>
Dredge and Fill and/or Work in Navigable Waters (404)	U. S. Army Corps of Engineers
Water Quality (401)	Division of Environmental Management, DEQ State of North Carolina
State Dredge and Fill and/or CAMA	Division of Coastal Management, DEQ State of North Carolina
Navigation	U. S. Coast Guard
CCPCUA	Division of Water Resources, DEQ State of North Carolina

The Contractor shall comply with all applicable permit conditions during construction of this project. Those conditions marked by * are the responsibility of the Department and the Contractor has no responsibility in accomplishing those conditions.

Agents of the permitting authority will periodically inspect the project for adherence to the permits.

The Contractor's attention is also directed to Articles 107-10 and 107-13 of the *2018 Standard Specifications* and the following:

Should the Contractor propose to utilize construction methods (such as temporary structures or fill in waters and/or wetlands for haul roads, work platforms, cofferdams, etc.) not specifically identified in the permit (individual, general, or nationwide) authorizing the project it shall be the Contractor's responsibility to coordinate with the Engineer to determine what, if any, additional permit action is required. The Contractor shall also be responsible for initiating the request for the authorization of such construction method by the permitting agency. The request shall be submitted through the Engineer. The Contractor shall not utilize the construction method until it is approved by the permitting agency. The request normally takes approximately 60 days to process; however, no extensions of time or additional compensation will be granted for delays resulting from the Contractor's request for approval of construction methods not specifically identified in the permit.

Where construction moratoriums are contained in a permit condition which restricts the Contractor's activities to certain times of the year, those moratoriums will apply only to the portions of the work taking place in the restricted waters, wetlands or buffer zones, provided that activities outside those areas is done in such a manner as to not affect the restricted waters, wetlands or buffer zones.



STATE OF NORTH CAROLINA
DEPARTMENT OF TRANSPORTATION

ROY COOPER
GOVERNOR

JAMES H. TROGDON, III
SECRETARY

October 15, 2019

MEMO TO: Michael Bass
Division Design Construct
Engineering Technician Advanced

FROM: Mason Herndon
Division Environmental Program Supervisor

SUBJECT: Section 404 Nationwide Permit 23 and Section 401 General Certifications
4140 for Northwest Quadrant Connection between US 74 (Eastwood
Road) and SR 1409 (Military Cutoff Road), Drysdale Road Extension,
WBS No. 50115.1.2, TIP No. U-5710A.

Attached are the US Army Corps of Engineers Nationwide Permit and N.C. Division of Water Resources (NCDWR) Water Quality Certification for the construction of TIP No. U-5710A, Northwest Quadrant Connection between US 74 (Eastwood Road) and SR 1409 (Military Cutoff Road), Drysdale Road Extension in New Hanover County. All environmental permits have been received for the construction of this project.

If you have any questions or if I can be of any further assistance, please do not hesitate to contact me.

ec:

Katie Hite, P.E. Division Project Development Engineer
David Leonard, P.E. Division Project Lead
Jonathan Mitchell, Division Contract & Proposals Engineer
Tim Banta, P.E. Assistant Program Manager

H. Project Commitments

**New Hanover County
Intersection Upgrade of Eastwood Road (US 74) / Military Cutoff Road (SR 1409)
Federal Project No. NHPP-0074 (159)
WBS No. 50116.1
STIP No. U-5710**

NCDOT Division 3

The Division 3 Project Manager will coordinate with the Wilmington Urban Area MPO and City of Wilmington on including design features to enhance the aesthetic quality and visual appearance of the project. Municipal agreements will be prepared, as applicable, prior to project construction.

The Division 3 Project Manager will coordinate with New Hanover County Emergency Management and E911 (910-798-6907), New Hanover County Schools Transportation Department (910-254-4080), and WAVE Transit (910-343-0106), to notify them of the schedule for potential closures and detour routes during construction activities at least one month prior to closure.

The Division 3 Project Manager shall notify affected property owners and businesses of the schedule for potential closures and detour routes during construction activities at least one month prior to construction.

The Division 3 Division Engineer shall make a final decision on the installation of noise abatement measures upon completion of the Final Traffic Noise Report, project design, the public involvement process, and concurrence with the NCDOT Traffic Noise Policy (2016).

Bicycle and pedestrian accommodations will be further coordinated with the City during final design. The Division 3 Project Manager will coordinate with the NCDOT Division of Bicycle and Pedestrian Transportation and with the City regarding the type and location of bicycle/ pedestrian crossings at major intersections.

NCDOT Hydraulics Unit

The Division 3 Project Manager will submit sealed as-built construction plans to the NCDOT Hydraulics Unit upon completion of project construction, certifying that the drainage structures were built as shown in the construction plans, both horizontally and vertically.

U.S. ARMY CORPS OF ENGINEERS
WILMINGTON DISTRICT

Action Id. SAW-2015-00703 County: New Hanover County U.S.G.S. Quad: Wrightsville Beach

GENERAL PERMIT (REGIONAL AND NATIONWIDE) VERIFICATION

Permittee:	<u>Ms. Karen Colette, PE</u> <u>NCDOT-Division 3 Engineer</u>	Agent:	<u>Mr. Mason Herndon</u> <u>NCDOT- Division 3 Env. Supervisor</u>
Address:	<u>5501 Barbados Blvd.</u> <u>Castle Hayne, NC 28429</u>		<u>5501 Barbados Blvd.</u> <u>Castle Hayne, NC 28429</u>
Size (acres)	<u>4.25</u>	Nearest Town	<u>Wrightsville Beach</u>
Nearest Waterway	<u>Onslow Bay</u>	River Basin	<u>Onslow Bay</u>
USGS HUC	<u>03020302</u>	Coordinates	Latitude: <u>34.2278930160568</u> Longitude: <u>-77.829976210102</u>

Location description: The project (U-5710 A) location is near the intersection of Eastwood and Military Cut Off Roads, New Hanover County.

Description of projects area and activity: The applicant is proposing a northwest quadrant connection between US 74 (Eastwood Road) and SR 1409 (Military Cutoff Road) which eliminates left turns from the main intersection thus improving the efficiency of the intersection. This verification covers channel improvements to 91' of stream channel (not a loss), 62' of stream relocation (self mitigating), and 372' of channel loss, requiring mitigation.

Applicable Law: Section 404 (Clean Water Act, 33 USC 1344)
 Section 10 (Rivers and Harbors Act, 33 USC 403)

Authorization: Regional General Permit Number and/or Nationwide Permit Number: **NW-23**
SEE ATTACHED RGP or NWP GENERAL, REGIONAL AND/OR SPECIAL CONDITIONS

Your work is authorized by the above referenced permit provided it is accomplished in strict accordance with the attached conditions and your submitted application dated 9/30/2019 and attached permit drawings 1-9 of 9 dated 7/29/2019, 8/16/2019, 8/19/2019, and 8/21/2019. Any violation of the attached conditions or deviation from your submitted plans may subject the permittee to a stop work order, a restoration order, a Class I administrative penalty, and/or appropriate legal action.

This verification will remain valid until the expiration date identified below unless the nationwide and/or regional general permit authorization is modified, suspended or revoked. If, prior to the expiration date identified below, the nationwide and/or regional general permit authorization is reissued and/or modified, this verification will remain valid until the expiration date identified below, provided it complies with all requirements of the modified nationwide permit. If the nationwide and/or regional general permit authorization expires or is suspended, revoked, or is modified, such that the activity would no longer comply with the terms and conditions of the nationwide permit, activities which have commenced (i.e., are under construction) or are under contract to commence in reliance upon the nationwide and/or regional general permit, will remain authorized provided the activity is completed within twelve months of the date of the nationwide and/or regional general permit's expiration, modification or revocation, unless discretionary authority has been exercised on a case-by-case basis to modify, suspend or revoke the authorization.

Activities subject to Section 404 (as indicated above) may also require an individual Section 401 Water Quality Certification. You should contact the NC Division of Water Resources (telephone 919-807-6300) to determine Section 401 requirements.

For activities occurring within the twenty coastal counties subject to regulation under the Coastal Area Management Act (CAMA), prior to beginning work you must contact the N.C. Division of Coastal Management in Morehead City, NC, at (252) 808-2808.

This Department of the Army verification does not relieve the permittee of the responsibility to obtain any other required Federal, State or local approvals/permits.

If there are any questions regarding this verification, any of the conditions of the Permit, or the Corps of Engineers regulatory program, please contact **Brad Shaver at (910) 251-4611 or Brad.E.Shaver@usace.army.mil.**

Corps Regulatory Official: 601756

SHAVER.BRAD.E.1276 Digitally signed by
SHAVER.BRAD.E.1276601756
Date: 2019.10.15 08:45:55 -04'00'

Date: **October 15, 2019**

Expiration Date of Verification: **March 18, 2022**

A. Determination of Jurisdiction:

1. There are waters, including wetlands, on the above described project area that may be subject to Section 404 of the Clean Water Act (CWA) (33 USC § 1344) and/or Section 10 of the Rivers and Harbors Act (RHA) (33 USC § 403). This preliminary determination is not an appealable action under the Regulatory Program Administrative Appeal Process (Reference 33 CFR Part 331). However, you may request an approved JD, which is an appealable action, by contacting the Corps district for further instruction. Please note, if work is authorized by either a general or nationwide permit, and you wish to request an appeal of an approved JD, the appeal must be received by the Corps and the appeal process concluded prior to the commencement of any work in waters of the United States and prior to any work that could alter the hydrology of waters of the United States.
2. There are Navigable Waters of the United States within the above described project area subject to the permit requirements of Section 10 of the Rivers and Harbors Act (RHA) (33 USC § 403) and Section 404 of the Clean Water Act (CWA) (33 USC § 1344). Unless there is a change in the law or our published regulations, this determination may be relied upon for a period not to exceed five years from the date of this notification.
3. There are waters, including wetlands, within the above described project area that are subject to the permit requirements of Section 404 of the Clean Water Act (CWA) (33 USC § 1344). Unless there is a change in the law or our published regulations, this determination may be relied upon for a period not to exceed five years from the date of this notification.
4. A jurisdiction determination was not completed with this request. Therefore, this is not an appealable action. However, you may request an approved JD, which is an appealable action, by contacting the Corps for further instruction.
5. The aquatic resources within the above described project area have been identified under a previous action. Please reference the approved jurisdictional determination issued 5/17/2019. Action ID: **SAW-2015-00703**.

B. Basis For Jurisdictional Determination: N/A. An Approved JD has not been completed.

C. Remarks: See attached special conditions and mitigation transfer form.

The Wilmington District is committed to providing the highest level of support to the public. To help us ensure we continue to do so, please complete our Customer Satisfaction Survey, located online at http://corpsmapu.usace.army.mil/cm_apex/f?p=136:4:0.

Copy furnished:

NCDEQ-DCM attn: Ms. Joanne Steenhuis
NC DMS attn: Ms. Beth Harmon
USACE attn: Mr. Todd Tugwell

SPECIAL CONDITIONS

U-5710 A

Northwestern Quadrant Connection between US 74 and SR 1409

1. All work must be performed in strict compliance with the plans attached to the application dated 9/30/2019 and updated plans sheet 1-9 of 9 dated 7/29/2019, 8/16/2019, 8/19/2019, and 8/21/2019 attached, which are authorized by this permit. Any modification to the authorized permit plans must be approved by the USACE prior to implementation.

2. Failure to institute and carry out the details of the following special conditions, below, will result in a directive to cease all ongoing and permitted work within waters and/or wetlands associated with the permitted project, or such other remedies and/or fines as the District Engineer or his authorized representatives may seek.

3. The permittee will ensure that the construction design plans for this project do not deviate from the authorized permit plans. Any deviation in the construction design plans will be brought to the attention of the Corps of Engineers, Wilmington Regulatory Field Office prior to any active construction in waters or wetlands.

4. The permittee shall require its contractors and/or agents to comply with the terms and conditions of this permit in the construction and maintenance of this project, and shall provide each of its contractors and/or agents associated with the construction or maintenance of this project with a copy of this permit, and any authorized modifications. A copy of this permit including the authorized plans referenced in Special Condition (1) and authorized modifications, including all conditions, shall be available at the project site during construction and maintenance of this project.

5. Except as authorized by this permit or any USACE approved modification to this permit, no excavation, fill, or mechanized land-clearing activities shall take place at any time in the construction or maintenance of this project, within waters or wetlands, or shall any activities take place that cause the degradation of waters or wetlands. In addition, except as specified in the plans attached to this permit, no excavation, fill or mechanized land-clearing activities shall take place at any time in the construction or maintenance of this project, in such a manner as to impair normal flows and circulation patterns within, into, or out of waters or wetlands or to reduce the reach of waters or wetlands.

This permit does not authorize temporary placement or double handling of excavated or fill material or construction equipment within waters or wetlands outside the permitted area.

6. To ensure that all borrow and waste activities occur on high ground and do not result in the degradation of adjacent wetlands and streams, except as authorized by this permit, the permittee shall require its contractors and/or agents to identify all areas to be used to borrow material, or to dispose of dredged, fill, or waste material. The permittee shall provide the USACE with appropriate maps indicating the locations of proposed borrow or waste sites as soon as the permittee has that information. The permittee will coordinate with the USACE before approving any borrow or waste sites that are within 400 feet of any

streams or wetlands. All jurisdictional wetland lines on borrow and waste sites shall be verified by the Corps of Engineers and shown on the approved reclamation plans. The permittee shall ensure that all such areas comply with the preceding condition of this permit, and shall require and maintain documentation of the location and characteristics of all borrow and disposal sites associated with this project. This information will include data regarding soils, vegetation and hydrology sufficient to clearly demonstrate compliance with the preceding condition. All information will be available to the USACE upon request. NCDOT shall require its contractors to complete and execute reclamation plans for each waste and borrow site and provide written documentation that the reclamation plans have been implemented and all work is completed. This documentation will be provided to the Corps of Engineers within 30 days of the completion of the reclamation work.

8. This USACE permit does not authorize you to take a threatened or endangered species, in particular, the Northern Long-eared Bat (NLEB) (*Myotis septentrionalis*). In order to legally take a listed species, you must have separate authorization under the Endangered Species Act (ESA) (e.g., a Biological Opinion (BO) under the ESA, Section 7, with “incidental take” provisions with which you must comply). The U.S. Fish and Wildlife Service’s (USFWS’s) Programmatic BO titled “Northern Long-eared Bat (NLEB) Programmatic Biological Opinion for North Carolina Department of Transportation (NCDOT) Activities in Eastern North Carolina (Divisions 1-8),” dated March 25, 2015, and adopted on April 10, 2015, contains mandatory terms and conditions to implement the reasonable and prudent measures that are associated with “incidental take” that are specified in the BO. Your authorization under this USACE permit is conditioned upon your compliance with all the mandatory terms and conditions (incorporated by reference into this permit) associated with incidental take of the BO. Failure to comply with the terms and conditions associated with incidental take of the BO, where a take of the listed species occurs, would constitute an unauthorized take, and would also constitute non-compliance with your USACE permit. The USFWS is the appropriate authority to determine compliance with the terms and conditions of its BO and with the ESA.

SHAVER.BRAD.E.1276601756
1276601756

Digitally signed by
SHAVER.BRAD.E.1276601756
Date: 2019.10.15 08:46:25 -04'00'

Brad Shaver

Action ID Number: SAW-2015-00703

County: New Hanover County

Permittee: Karen Collette
NCDOT-Division 3

Project Name: NCDOT / U 5710 A / US 74 at SR 1409 / Eastwood at Military Cut Off / WBS
No. 50115.1.FS1 / Div 3

Date Verification Issued: October 15, 2019

Project Manager: Brad Shaver

Upon completion of the activity authorized by this permit and any mitigation required by the permit, sign this certification and return it to the following address:

US ARMY CORPS OF ENGINEERS
WILMINGTON DISTRICT
Attn: Brad Shaver
69 Darlington Ave
Wilmington, NC 28403

Please note that your permitted activity is subject to a compliance inspection by a U. S. Army Corps of Engineers representative. Failure to comply with any terms or conditions of this authorization may result in the Corps suspending, modifying or revoking the authorization and/or issuing a Class I administrative penalty, or initiating other appropriate legal action.

I hereby certify that the work authorized by the above referenced permit has been completed in accordance with the terms and condition of the said permit, and required mitigation was completed in accordance with the permit conditions.

Signature of Permittee

Date

**NATIONWIDE PERMIT 23
DEPARTMENT OF THE ARMY
CORPS OF ENGINEERS
FINAL NOTICE OF ISSUANCE AND MODIFICATION OF NATIONWIDE PERMITS
FEDERAL REGISTER
AUTHORIZED MARCH 19, 2017**

Approved Categorical Exclusions. Activities undertaken, assisted, authorized, regulated, funded, or financed, in whole or in part, by another Federal agency or department where:

(a) That agency or department has determined, pursuant to the Council on Environmental Quality's implementing regulations for the National Environmental Policy Act (40 CFR part 1500 et seq.), that the activity is categorically excluded from the requirement to prepare an environmental impact statement or environmental assessment analysis, because it is included within a category of actions which neither individually nor cumulatively have a significant effect on the human environment; and

(b) The Office of the Chief of Engineers (Attn: CECW-CO) has concurred with that agency's or department's determination that the activity is categorically excluded and approved the activity for authorization under NWP 23.

The Office of the Chief of Engineers may require additional conditions, including pre-construction notification, for authorization of an agency's categorical exclusions under this NWP.

Notification: Certain categorical exclusions approved for authorization under this NWP require the permittee to submit a pre-construction notification to the district engineer prior to commencing the activity (see general condition 32). The activities that require pre-construction notification are listed in the appropriate Regulatory Guidance Letters. (Authorities: Sections 10 and 404)

Note: The agency or department may submit an application for an activity believed to be categorically excluded to the Office of the Chief of Engineers (Attn: CECW-CO). Prior to approval for authorization under this NWP of any agency's activity, the Office of the Chief of Engineers will solicit public comment. As of the date of issuance of this NWP, agencies with approved categorical exclusions are: the Bureau of Reclamation, Federal Highway Administration, and U.S. Coast Guard. Activities approved for authorization under this NWP as of the date of this notice are found in Corps Regulatory Guidance Letter 05-07, which is available at: <http://www.usace.army.mil/Portals/2/docs/civilworks/RGLS/rgl05-07.pdf>. Any future approved categorical exclusions will be announced in Regulatory Guidance Letters and posted on this same web site.

NATIONWIDE PERMIT GENERAL CONDITIONS

The following General Conditions must be followed in order for any authorization by a NWP to be valid:

1. Navigation. (a) No activity may cause more than a minimal adverse effect on navigation.
(b) Any safety lights and signals prescribed by the U.S. Coast Guard, through regulations or otherwise, must be installed and maintained at the permittee's expense on authorized facilities in navigable waters of the United States.
(c) The permittee understands and agrees that, if future operations by the United States require the removal, relocation, or other alteration, of the structure or work herein authorized, or if, in the opinion of the Secretary of the Army or his authorized representative, said structure or work shall cause unreasonable obstruction to the free navigation of the navigable waters, the permittee will be required, upon due notice from the Corps of Engineers, to remove, relocate, or alter the structural work or obstructions caused thereby, without expense to the United States. No claim shall be made against the United States on account of any such removal or alteration.

2. Aquatic Life Movements. No activity may substantially disrupt the necessary life cycle movements of those species of aquatic life indigenous to the waterbody, including those species that normally migrate through the area, unless the activity's primary purpose is to impound water. All permanent and temporary crossings of waterbodies shall be suitably culverted, bridged, or otherwise designed and constructed to maintain low flows to sustain the movement of those aquatic species. If a bottomless culvert cannot be used, then the crossing should be designed and constructed to minimize adverse effects to aquatic life movements.

3. Spawning Areas. Activities in spawning areas during spawning seasons must be avoided to the maximum extent practicable. Activities that result in the physical destruction (e.g., through excavation, fill, or downstream smothering by substantial turbidity) of an important spawning area are not authorized.

4. Migratory Bird Breeding Areas. Activities in waters of the United States that serve as breeding areas for migratory birds must be avoided to the maximum extent practicable.

5. Shellfish Beds. No activity may occur in areas of concentrated shellfish populations, unless the activity is directly related to a shellfish harvesting activity authorized by NWPs 4 and 48, or is a shellfish seeding or habitat restoration activity authorized by NWP 27.

6. Suitable Material. No activity may use unsuitable material (e.g., trash, debris, car bodies, asphalt, etc.). Material used for construction or discharged must be free from toxic pollutants in toxic amounts (see section 307 of the Clean Water Act).

7. Water Supply Intakes. No activity may occur in the proximity of a public water supply intake, except where the activity is for the repair or improvement of public water supply intake structures or adjacent bank stabilization.

8. Adverse Effects From Impoundments. If the activity creates an impoundment of water, adverse effects to the aquatic system due to accelerating the passage of water, and/or restricting its flow must be minimized to the maximum extent practicable.

9. Management of Water Flows. To the maximum extent practicable, the pre-construction course, condition, capacity, and location of open waters must be maintained for each activity, including stream channelization, storm water management activities, and temporary and permanent road crossings, except as provided below. The activity must be constructed to withstand expected high flows. The activity must not restrict or impede the passage of normal or high flows, unless the primary purpose of the activity is to impound water or manage high flows. The activity may alter the pre-construction course, condition, capacity, and location of open waters if it benefits the aquatic environment (e.g., stream restoration or relocation activities).

10. Fills Within 100-Year Floodplains. The activity must comply with applicable FEMA-approved state or local floodplain management requirements.

11. Equipment. Heavy equipment working in wetlands or mudflats must be placed on mats, or other measures must be taken to minimize soil disturbance.

12. Soil Erosion and Sediment Controls. Appropriate soil erosion and sediment controls must be used and maintained in effective operating condition during construction, and all exposed soil and other fills, as well as any work below the ordinary high water mark or high tide line, must be permanently stabilized at the earliest practicable date. Permittees are encouraged to perform work within waters of the United States during periods of low-flow or no-flow, or during low tides.

13. Removal of Temporary Fills. Temporary fills must be removed in their entirety and the affected areas returned to pre-construction elevations. The affected areas must be revegetated, as appropriate.

14. Proper Maintenance. Any authorized structure or fill shall be properly maintained, including maintenance to ensure public safety and compliance with applicable NWP general conditions, as well as any activity-specific conditions added by the district engineer to an NWP authorization.

15. Single and Complete Project. The activity must be a single and complete project. The same NWP cannot be used more than once for the same single and complete project.

16. Wild and Scenic Rivers. (a) No NWP activity may occur in a component of the National Wild and Scenic River System, or in a river officially designated by Congress as a “study river” for possible inclusion in the system while the river is in an official study status,

unless the appropriate Federal agency with direct management responsibility for such river, has determined in writing that the proposed activity will not adversely affect the Wild and Scenic River designation or study status.

(b) If a proposed NWP activity will occur in a component of the National Wild and Scenic River System, or in a river officially designated by Congress as a “study river” for possible inclusion in the system while the river is in an official study status, the permittee must submit a pre-construction notification (see general condition 32). The district engineer will coordinate the PCN with the Federal agency with direct management responsibility for that river. The permittee shall not begin the NWP activity until notified by the district engineer that the Federal agency with direct management responsibility for that river has determined in writing that the proposed NWP activity will not adversely affect the Wild and Scenic River designation or study status.

(c) Information on Wild and Scenic Rivers may be obtained from the appropriate Federal land management agency responsible for the designated Wild and Scenic River or study river (e.g., National Park Service, U.S. Forest Service, Bureau of Land Management, U.S. Fish and Wildlife Service). Information on these rivers is also available at: <http://www.rivers.gov/>.

17. Tribal Rights. No NWP activity may cause more than minimal adverse effects on tribal rights (including treaty rights), protected tribal resources, or tribal lands.

18. Endangered Species. (a) No activity is authorized under any NWP which is likely to directly or indirectly jeopardize the continued existence of a threatened or endangered species or a species proposed for such designation, as identified under the Federal Endangered Species Act (ESA), or which will directly or indirectly destroy or adversely modify the critical habitat of such species. No activity is authorized under any NWP which “may affect” a listed species or critical habitat, unless ESA section 7 consultation addressing the effects of the proposed activity has been completed. Direct effects are the immediate effects on listed species and critical habitat caused by the NWP activity. Indirect effects are those effects on listed species and critical habitat that are caused by the NWP activity and are later in time, but still are reasonably certain to occur.

(b) Federal agencies should follow their own procedures for complying with the requirements of the ESA. If pre-construction notification is required for the proposed activity, the Federal permittee must provide the district engineer with the appropriate documentation to demonstrate compliance with those requirements. The district engineer will verify that the appropriate documentation has been submitted. If the appropriate documentation has not been submitted, additional ESA section 7 consultation may be necessary for the activity and the respective federal agency would be responsible for fulfilling its obligation under section 7 of the ESA.

(c) Non-federal permittees must submit a pre-construction notification to the district engineer if any listed species or designated critical habitat might be affected or is in the vicinity of the activity, or if the activity is located in designated critical habitat, and shall not begin work on the activity until notified by the district engineer that the requirements of the ESA have been satisfied and that the activity is authorized. For activities that might affect Federally-listed endangered or threatened species or designated critical habitat, the pre-construction notification must include the name(s) of the endangered or threatened species that

might be affected by the proposed activity or that utilize the designated critical habitat that might be affected by the proposed activity. The district engineer will determine whether the proposed activity “may affect” or will have “no effect” to listed species and designated critical habitat and will notify the non-Federal applicant of the Corps’ determination within 45 days of receipt of a complete pre-construction notification. In cases where the non-Federal applicant has identified listed species or critical habitat that might be affected or is in the vicinity of the activity, and has so notified the Corps, the applicant shall not begin work until the Corps has provided notification that the proposed activity will have “no effect” on listed species or critical habitat, or until ESA section 7 consultation has been completed. If the non-Federal applicant has not heard back from the Corps within 45 days, the applicant must still wait for notification from the Corps.

(d) As a result of formal or informal consultation with the FWS or NMFS the district engineer may add species-specific permit conditions to the NWP.

(e) Authorization of an activity by an NWP does not authorize the “take” of a threatened or endangered species as defined under the ESA. In the absence of separate authorization (e.g., an ESA Section 10 Permit, a Biological Opinion with “incidental take” provisions, etc.) from the FWS or the NMFS, the Endangered Species Act prohibits any person subject to the jurisdiction of the United States to take a listed species, where “take” means to harass, harm, pursue, hunt, shoot, wound, kill, trap, capture, or collect, or to attempt to engage in any such conduct. The word “harm” in the definition of “take” means an act which actually kills or injures wildlife. Such an act may include significant habitat modification or degradation where it actually kills or injures wildlife by significantly impairing essential behavioral patterns, including breeding, feeding or sheltering.

(f) If the non-federal permittee has a valid ESA section 10(a)(1)(B) incidental take permit with an approved Habitat Conservation Plan for a project or a group of projects that includes the proposed NWP activity, the non-federal applicant should provide a copy of that ESA section 10(a)(1)(B) permit with the PCN required by paragraph (c) of this general condition. The district engineer will coordinate with the agency that issued the ESA section 10(a)(1)(B) permit to determine whether the proposed NWP activity and the associated incidental take were considered in the internal ESA section 7 consultation conducted for the ESA section 10(a)(1)(B) permit. If that coordination results in concurrence from the agency that the proposed NWP activity and the associated incidental take were considered in the internal ESA section 7 consultation for the ESA section 10(a)(1)(B) permit, the district engineer does not need to conduct a separate ESA section 7 consultation for the proposed NWP activity. The district engineer will notify the non-federal applicant within 45 days of receipt of a complete pre-construction notification whether the ESA section 10(a)(1)(B) permit covers the proposed NWP activity or whether additional ESA section 7 consultation is required.

(g) Information on the location of threatened and endangered species and their critical habitat can be obtained directly from the offices of the FWS and NMFS or their world wide web pages at <http://www.fws.gov/> or <http://www.fws.gov/ipac> and <http://www.nmfs.noaa.gov/pr/species/esa/> respectively.

19. Migratory Birds and Bald and Golden Eagles. The permittee is responsible for ensuring their action complies with the Migratory Bird Treaty Act and the Bald and Golden Eagle Protection Act. The permittee is responsible for contacting appropriate local office of the U.S. Fish and Wildlife Service to determine applicable measures to reduce impacts to migratory

birds or eagles, including whether “incidental take” permits are necessary and available under the Migratory Bird Treaty Act or Bald and Golden Eagle Protection Act for a particular activity.

20. Historic Properties. (a) In cases where the district engineer determines that the activity may have the potential to cause effects to properties listed, or eligible for listing, in the National Register of Historic Places, the activity is not authorized, until the requirements of Section 106 of the National Historic Preservation Act (NHPA) have been satisfied.

(b) Federal permittees should follow their own procedures for complying with the requirements of section 106 of the National Historic Preservation Act. If pre-construction notification is required for the proposed NWP activity, the Federal permittee must provide the district engineer with the appropriate documentation to demonstrate compliance with those requirements. The district engineer will verify that the appropriate documentation has been submitted. If the appropriate documentation is not submitted, then additional consultation under section 106 may be necessary. The respective federal agency is responsible for fulfilling its obligation to comply with section 106.

(c) Non-federal permittees must submit a pre-construction notification to the district engineer if the NWP activity might have the potential to cause effects to any historic properties listed on, determined to be eligible for listing on, or potentially eligible for listing on the National Register of Historic Places, including previously unidentified properties. For such activities, the pre-construction notification must state which historic properties might have the potential to be affected by the proposed NWP activity or include a vicinity map indicating the location of the historic properties or the potential for the presence of historic properties. Assistance regarding information on the location of, or potential for, the presence of historic properties can be sought from the State Historic Preservation Officer, Tribal Historic Preservation Officer, or designated tribal representative, as appropriate, and the National Register of Historic Places (see 33 CFR 330.4(g)). When reviewing pre-construction notifications, district engineers will comply with the current procedures for addressing the requirements of section 106 of the National Historic Preservation Act. The district engineer shall make a reasonable and good faith effort to carry out appropriate identification efforts, which may include background research, consultation, oral history interviews, sample field investigation, and field survey. Based on the information submitted in the PCN and these identification efforts, the district engineer shall determine whether the proposed NWP activity has the potential to cause effects on the historic properties. Section 106 consultation is not required when the district engineer determines that the activity does not have the potential to cause effects on historic properties (see 36 CFR 800.3(a)). Section 106 consultation is required when the district engineer determines that the activity has the potential to cause effects on historic properties. The district engineer will conduct consultation with consulting parties identified under 36 CFR 800.2(c) when he or she makes any of the following effect determinations for the purposes of section 106 of the NHPA: no historic properties affected, no adverse effect, or adverse effect. Where the non-Federal applicant has identified historic properties on which the activity might have the potential to cause effects and so notified the Corps, the non-Federal applicant shall not begin the activity until notified by the district engineer either that the activity has no potential to cause effects to historic properties or that NHPA section 106 consultation has been completed.

(d) For non-federal permittees, the district engineer will notify the prospective permittee within 45 days of receipt of a complete pre-construction notification whether NHPA section 106 consultation is required. If NHPA section 106 consultation is required, the district engineer will notify the non-Federal applicant that he or she cannot begin the activity until section 106 consultation is completed. If the non-Federal applicant has not heard back from the Corps within 45 days, the applicant must still wait for notification from the Corps.

(e) Prospective permittees should be aware that section 110k of the NHPA (54 U.S.C. 306113) prevents the Corps from granting a permit or other assistance to an applicant who, with intent to avoid the requirements of section 106 of the NHPA, has intentionally significantly adversely affected a historic property to which the permit would relate, or having legal power to prevent it, allowed such significant adverse effect to occur, unless the Corps, after consultation with the Advisory Council on Historic Preservation (ACHP), determines that circumstances justify granting such assistance despite the adverse effect created or permitted by the applicant. If circumstances justify granting the assistance, the Corps is required to notify the ACHP and provide documentation specifying the circumstances, the degree of damage to the integrity of any historic properties affected, and proposed mitigation. This documentation must include any views obtained from the applicant, SHPO/THPO, appropriate Indian tribes if the undertaking occurs on or affects historic properties on tribal lands or affects properties of interest to those tribes, and other parties known to have a legitimate interest in the impacts to the permitted activity on historic properties.

21. Discovery of Previously Unknown Remains and Artifacts. If you discover any previously unknown historic, cultural or archeological remains and artifacts while accomplishing the activity authorized by this permit, you must immediately notify the district engineer of what you have found, and to the maximum extent practicable, avoid construction activities that may affect the remains and artifacts until the required coordination has been completed. The district engineer will initiate the Federal, Tribal, and state coordination required to determine if the items or remains warrant a recovery effort or if the site is eligible for listing in the National Register of Historic Places.

22. Designated Critical Resource Waters. Critical resource waters include, NOAA-managed marine sanctuaries and marine monuments, and National Estuarine Research Reserves. The district engineer may designate, after notice and opportunity for public comment, additional waters officially designated by a state as having particular environmental or ecological significance, such as outstanding national resource waters or state natural heritage sites. The district engineer may also designate additional critical resource waters after notice and opportunity for public comment.

(a) Discharges of dredged or fill material into waters of the United States are not authorized by NWPs 7, 12, 14, 16, 17, 21, 29, 31, 35, 39, 40, 42, 43, 44, 49, 50, 51, and 52 for any activity within, or directly affecting, critical resource waters, including wetlands adjacent to such waters.

(b) For NWPs 3, 8, 10, 13, 15, 18, 19, 22, 23, 25, 27, 28, 30, 33, 34, 36, 37, 38, and 54, notification is required in accordance with general condition 32, for any activity proposed in the designated critical resource waters including wetlands adjacent to those waters. The district engineer may authorize activities under these NWPs only after it is determined that the impacts to the critical resource waters will be no more than minimal.

23. Mitigation. The district engineer will consider the following factors when determining appropriate and practicable mitigation necessary to ensure that the individual and cumulative adverse environmental effects are no more than minimal:

(a) The activity must be designed and constructed to avoid and minimize adverse effects, both temporary and permanent, to waters of the United States to the maximum extent practicable at the project site (i.e., on site).

(b) Mitigation in all its forms (avoiding, minimizing, rectifying, reducing, or compensating for resource losses) will be required to the extent necessary to ensure that the individual and cumulative adverse environmental effects are no more than minimal.

(c) Compensatory mitigation at a minimum one-for-one ratio will be required for all wetland losses that exceed 1/10-acre and require pre-construction notification, unless the district engineer determines in writing that either some other form of mitigation would be more environmentally appropriate or the adverse environmental effects of the proposed activity are no more than minimal, and provides an activity-specific waiver of this requirement. For wetland losses of 1/10-acre or less that require pre-construction notification, the district engineer may determine on a case-by-case basis that compensatory mitigation is required to ensure that the activity results in only minimal adverse environmental effects.

(d) For losses of streams or other open waters that require pre-construction notification, the district engineer may require compensatory mitigation to ensure that the activity results in no more than minimal adverse environmental effects. Compensatory mitigation for losses of streams should be provided, if practicable, through stream rehabilitation, enhancement, or preservation, since streams are difficult-to-replace resources (see 33 CFR 332.3(e)(3)).

(e) Compensatory mitigation plans for NWP activities in or near streams or other open waters will normally include a requirement for the restoration or enhancement, maintenance, and legal protection (e.g., conservation easements) of riparian areas next to open waters. In some cases, the restoration or maintenance/protection of riparian areas may be the only compensatory mitigation required. Restored riparian areas should consist of native species. The width of the required riparian area will address documented water quality or aquatic habitat loss concerns. Normally, the riparian area will be 25 to 50 feet wide on each side of the stream, but the district engineer may require slightly wider riparian areas to address documented water quality or habitat loss concerns. If it is not possible to restore or maintain/protect a riparian area on both sides of a stream, or if the waterbody is a lake or coastal waters, then restoring or maintaining/protecting a riparian area along a single bank or shoreline may be sufficient. Where both wetlands and open waters exist on the project site, the district engineer will determine the appropriate compensatory mitigation (e.g., riparian areas and/or wetlands compensation) based on what is best for the aquatic environment on a watershed basis. In cases where riparian areas are determined to be the most appropriate form of minimization or compensatory mitigation, the district engineer may waive or reduce the requirement to provide wetland compensatory mitigation for wetland losses.

(f) Compensatory mitigation projects provided to offset losses of aquatic resources must comply with the applicable provisions of 33 CFR part 332.

(1) The prospective permittee is responsible for proposing an appropriate compensatory mitigation option if compensatory mitigation is necessary to ensure that the activity results in no more than minimal adverse environmental effects. For the NWPs, the preferred mechanism for providing compensatory mitigation is mitigation bank credits or in-

lieu fee program credits (see 33 CFR 332.3(b)(2) and (3)). However, if an appropriate number and type of mitigation bank or in-lieu credits are not available at the time the PCN is submitted to the district engineer, the district engineer may approve the use of permittee-responsible mitigation.

(2) The amount of compensatory mitigation required by the district engineer must be sufficient to ensure that the authorized activity results in no more than minimal individual and cumulative adverse environmental effects (see 33 CFR 330.1(e)(3)). (See also 33 CFR 332.3(f)).

(3) Since the likelihood of success is greater and the impacts to potentially valuable uplands are reduced, aquatic resource restoration should be the first compensatory mitigation option considered for permittee-responsible mitigation.

(4) If permittee-responsible mitigation is the proposed option, the prospective permittee is responsible for submitting a mitigation plan. A conceptual or detailed mitigation plan may be used by the district engineer to make the decision on the NWP verification request, but a final mitigation plan that addresses the applicable requirements of 33 CFR 332.4(c)(2) through (14) must be approved by the district engineer before the permittee begins work in waters of the United States, unless the district engineer determines that prior approval of the final mitigation plan is not practicable or not necessary to ensure timely completion of the required compensatory mitigation (see 33 CFR 332.3(k)(3)).

(5) If mitigation bank or in-lieu fee program credits are the proposed option, the mitigation plan only needs to address the baseline conditions at the impact site and the number of credits to be provided.

(6) Compensatory mitigation requirements (e.g., resource type and amount to be provided as compensatory mitigation, site protection, ecological performance standards, monitoring requirements) may be addressed through conditions added to the NWP authorization, instead of components of a compensatory mitigation plan (see 33 CFR 332.4(c)(1)(ii)).

(g) Compensatory mitigation will not be used to increase the acreage losses allowed by the acreage limits of the NWPs. For example, if an NWP has an acreage limit of 1/2-acre, it cannot be used to authorize any NWP activity resulting in the loss of greater than 1/2-acre of waters of the United States, even if compensatory mitigation is provided that replaces or restores some of the lost waters. However, compensatory mitigation can and should be used, as necessary, to ensure that an NWP activity already meeting the established acreage limits also satisfies the no more than minimal impact requirement for the NWPs.

(h) Permittees may propose the use of mitigation banks, in-lieu fee programs, or permittee-responsible mitigation. When developing a compensatory mitigation proposal, the permittee must consider appropriate and practicable options consistent with the framework at 33 CFR 332.3(b). For activities resulting in the loss of marine or estuarine resources, permittee-responsible mitigation may be environmentally preferable if there are no mitigation banks or in-lieu fee programs in the area that have marine or estuarine credits available for sale or transfer to the permittee. For permittee-responsible mitigation, the special conditions of the NWP verification must clearly indicate the party or parties responsible for the implementation and performance of the compensatory mitigation project, and, if required, its long-term management.

(i) Where certain functions and services of waters of the United States are permanently adversely affected by a regulated activity, such as discharges of dredged or fill

material into waters of the United States that will convert a forested or scrub-shrub wetland to a herbaceous wetland in a permanently maintained utility line right-of-way, mitigation may be required to reduce the adverse environmental effects of the activity to the no more than minimal level.

24. Safety of Impoundment Structures. To ensure that all impoundment structures are safely designed, the district engineer may require non-Federal applicants to demonstrate that the structures comply with established state dam safety criteria or have been designed by qualified persons. The district engineer may also require documentation that the design has been independently reviewed by similarly qualified persons, and appropriate modifications made to ensure safety.

25. Water Quality. Where States and authorized Tribes, or EPA where applicable, have not previously certified compliance of an NWP with CWA section 401, individual 401 Water Quality Certification must be obtained or waived (see 33 CFR 330.4(c)). The district engineer or State or Tribe may require additional water quality management measures to ensure that the authorized activity does not result in more than minimal degradation of water quality.

26. Coastal Zone Management. In coastal states where an NWP has not previously received a state coastal zone management consistency concurrence, an individual state coastal zone management consistency concurrence must be obtained, or a presumption of concurrence must occur (see 33 CFR 330.4(d)). The district engineer or a State may require additional measures to ensure that the authorized activity is consistent with state coastal zone management requirements.

27. Regional and Case-By-Case Conditions. The activity must comply with any regional conditions that may have been added by the Division Engineer (see 33 CFR 330.4(e)) and with any case specific conditions added by the Corps or by the state, Indian Tribe, or U.S. EPA in its section 401 Water Quality Certification, or by the state in its Coastal Zone Management Act consistency determination.

28. Use of Multiple Nationwide Permits. The use of more than one NWP for a single and complete project is prohibited, except when the acreage loss of waters of the United States authorized by the NWPs does not exceed the acreage limit of the NWP with the highest specified acreage limit. For example, if a road crossing over tidal waters is constructed under NWP 14, with associated bank stabilization authorized by NWP 13, the maximum acreage loss of waters of the United States for the total project cannot exceed 1/3-acre.

29. Transfer of Nationwide Permit Verifications. If the permittee sells the property associated with a nationwide permit verification, the permittee may transfer the nationwide permit verification to the new owner by submitting a letter to the appropriate Corps district office to validate the transfer. A copy of the nationwide permit verification must be attached to the letter, and the letter must contain the following statement and signature:
“When the structures or work authorized by this nationwide permit are still in existence at the time the property is transferred, the terms and conditions of this nationwide permit, including any special conditions, will continue to be binding on the new owner(s) of the property. To

validate the transfer of this nationwide permit and the associated liabilities associated with compliance with its terms and conditions, have the transferee sign and date below.”

(Transferee)

(Date)

30. Compliance Certification. Each permittee who receives an NWP verification letter from the Corps must provide a signed certification documenting completion of the authorized activity and implementation of any required compensatory mitigation. The success of any required permittee-responsible mitigation, including the achievement of ecological performance standards, will be addressed separately by the district engineer. The Corps will provide the permittee the certification document with the NWP verification letter. The certification document will include:

(a) A statement that the authorized activity was done in accordance with the NWP authorization, including any general, regional, or activity-specific conditions;

(b) A statement that the implementation of any required compensatory mitigation was completed in accordance with the permit conditions. If credits from a mitigation bank or in-lieu fee program are used to satisfy the compensatory mitigation requirements, the certification must include the documentation required by 33 CFR 332.3(l)(3) to confirm that the permittee secured the appropriate number and resource type of credits; and

(c) The signature of the permittee certifying the completion of the activity and mitigation.

The completed certification document must be submitted to the district engineer within 30 days of completion of the authorized activity or the implementation of any required compensatory mitigation, whichever occurs later.

31. Activities Affecting Structures or Works Built by the United States. If an NWP activity also requires permission from the Corps pursuant to 33 U.S.C. 408 because it will alter or temporarily or permanently occupy or use a U.S. Army Corps of Engineers (USACE) federally authorized Civil Works project (a “USACE project”), the prospective permittee must submit a pre-construction notification. See paragraph (b)(10) of general condition 32. An activity that requires section 408 permission is not authorized by NWP until the appropriate Corps office issues the section 408 permission to alter, occupy, or use the USACE project, and the district engineer issues a written NWP verification.

32. Pre-Construction Notification. (a) Timing. Where required by the terms of the NWP, the prospective permittee must notify the district engineer by submitting a pre-construction notification (PCN) as early as possible. The district engineer must determine if the PCN is complete within 30 calendar days of the date of receipt and, if the PCN is determined to be incomplete, notify the prospective permittee within that 30 day period to request the additional information necessary to make the PCN complete. The request must specify the information needed to make the PCN complete. As a general rule, district engineers will request additional information necessary to make the PCN complete only once. However, if the

prospective permittee does not provide all of the requested information, then the district engineer will notify the prospective permittee that the PCN is still incomplete and the PCN review process will not commence until all of the requested information has been received by the district engineer. The prospective permittee shall not begin the activity until either:

(1) He or she is notified in writing by the district engineer that the activity may proceed under the NWP with any special conditions imposed by the district or division engineer; or

(2) 45 calendar days have passed from the district engineer's receipt of the complete PCN and the prospective permittee has not received written notice from the district or division engineer. However, if the permittee was required to notify the Corps pursuant to general condition 18 that listed species or critical habitat might be affected or are in the vicinity of the activity, or to notify the Corps pursuant to general condition 20 that the activity might have the potential to cause effects to historic properties, the permittee cannot begin the activity until receiving written notification from the Corps that there is "no effect" on listed species or "no potential to cause effects" on historic properties, or that any consultation required under Section 7 of the Endangered Species Act (see 33 CFR 330.4(f)) and/or section 106 of the National Historic Preservation Act (see 33 CFR 330.4(g)) has been completed. Also, work cannot begin under NWPs 21, 49, or 50 until the permittee has received written approval from the Corps. If the proposed activity requires a written waiver to exceed specified limits of an NWP, the permittee may not begin the activity until the district engineer issues the waiver. If the district or division engineer notifies the permittee in writing that an individual permit is required within 45 calendar days of receipt of a complete PCN, the permittee cannot begin the activity until an individual permit has been obtained. Subsequently, the permittee's right to proceed under the NWP may be modified, suspended, or revoked only in accordance with the procedure set forth in 33 CFR 330.5(d)(2).

(b) Contents of Pre-Construction Notification: The PCN must be in writing and include the following information:

(1) Name, address and telephone numbers of the prospective permittee;

(2) Location of the proposed activity;

(3) Identify the specific NWP or NWP(s) the prospective permittee wants to use to authorize the proposed activity;

(4) A description of the proposed activity; the activity's purpose; direct and indirect adverse environmental effects the activity would cause, including the anticipated amount of loss of wetlands, other special aquatic sites, and other waters expected to result from the NWP activity, in acres, linear feet, or other appropriate unit of measure; a description of any proposed mitigation measures intended to reduce the adverse environmental effects caused by the proposed activity; and any other NWP(s), regional general permit(s), or individual permit(s) used or intended to be used to authorize any part of the proposed project or any related activity, including other separate and distant crossings for linear projects that require Department of the Army authorization but do not require pre-construction notification. The description of the proposed activity and any proposed mitigation measures should be sufficiently detailed to allow the district engineer to determine that the adverse environmental effects of the activity will be no more than minimal and to determine the need for compensatory mitigation or other mitigation measures. For single and complete linear projects, the PCN must include the quantity of anticipated losses of wetlands, other special aquatic sites, and other waters for each single and complete crossing of those wetlands, other special aquatic sites, and other waters.

Sketches should be provided when necessary to show that the activity complies with the terms of the NWP. (Sketches usually clarify the activity and when provided results in a quicker decision. Sketches should contain sufficient detail to provide an illustrative description of the proposed activity (e.g., a conceptual plan), but do not need to be detailed engineering plans);

(5) The PCN must include a delineation of wetlands, other special aquatic sites, and other waters, such as lakes and ponds, and perennial, intermittent, and ephemeral streams, on the project site. Wetland delineations must be prepared in accordance with the current method required by the Corps. The permittee may ask the Corps to delineate the special aquatic sites and other waters on the project site, but there may be a delay if the Corps does the delineation, especially if the project site is large or contains many wetlands, other special aquatic sites, and other waters. Furthermore, the 45 day period will not start until the delineation has been submitted to or completed by the Corps, as appropriate;

(6) If the proposed activity will result in the loss of greater than 1/10-acre of wetlands and a PCN is required, the prospective permittee must submit a statement describing how the mitigation requirement will be satisfied, or explaining why the adverse environmental effects are no more than minimal and why compensatory mitigation should not be required. As an alternative, the prospective permittee may submit a conceptual or detailed mitigation plan.

(7) For non-Federal permittees, if any listed species or designated critical habitat might be affected or is in the vicinity of the activity, or if the activity is located in designated critical habitat, the PCN must include the name(s) of those endangered or threatened species that might be affected by the proposed activity or utilize the designated critical habitat that might be affected by the proposed activity. For NWP activities that require pre-construction notification, Federal permittees must provide documentation demonstrating compliance with the Endangered Species Act;

(8) For non-Federal permittees, if the NWP activity might have the potential to cause effects to a historic property listed on, determined to be eligible for listing on, or potentially eligible for listing on, the National Register of Historic Places, the PCN must state which historic property might have the potential to be affected by the proposed activity or include a vicinity map indicating the location of the historic property. For NWP activities that require pre-construction notification, Federal permittees must provide documentation demonstrating compliance with section 106 of the National Historic Preservation Act;

(9) For an activity that will occur in a component of the National Wild and Scenic River System, or in a river officially designated by Congress as a “study river” for possible inclusion in the system while the river is in an official study status, the PCN must identify the Wild and Scenic River or the “study river” (see general condition 16); and

(10) For an activity that requires permission from the Corps pursuant to 33 U.S.C. 408 because it will alter or temporarily or permanently occupy or use a U.S. Army Corps of Engineers federally authorized civil works project, the pre-construction notification must include a statement confirming that the project proponent has submitted a written request for section 408 permission from the Corps office having jurisdiction over that USACE project.

(c) Form of Pre-Construction Notification: The standard individual permit application form (Form ENG 4345) may be used, but the completed application form must clearly indicate that it is an NWP PCN and must include all of the applicable information required in paragraphs (b)(1) through (10) of this general condition. A letter containing the required information may also be used. Applicants may provide electronic files of PCNs and

supporting materials if the district engineer has established tools and procedures for electronic submittals.

(d) Agency Coordination: (1) The district engineer will consider any comments from Federal and state agencies concerning the proposed activity's compliance with the terms and conditions of the NWPs and the need for mitigation to reduce the activity's adverse environmental effects so that they are no more than minimal.

(2) Agency coordination is required for: (i) all NWP activities that require pre-construction notification and result in the loss of greater than 1/2-acre of waters of the United States; (ii) NWP 21, 29, 39, 40, 42, 43, 44, 50, 51, and 52 activities that require pre-construction notification and will result in the loss of greater than 300 linear feet of stream bed; (iii) NWP 13 activities in excess of 500 linear feet, fills greater than one cubic yard per running foot, or involve discharges of dredged or fill material into special aquatic sites; and (iv) NWP 54 activities in excess of 500 linear feet, or that extend into the waterbody more than 30 feet from the mean low water line in tidal waters or the ordinary high water mark in the Great Lakes.

(3) When agency coordination is required, the district engineer will immediately provide (e.g., via e-mail, facsimile transmission, overnight mail, or other expeditious manner) a copy of the complete PCN to the appropriate Federal or state offices (FWS, state natural resource or water quality agency, EPA, and, if appropriate, the NMFS). With the exception of NWP 37, these agencies will have 10 calendar days from the date the material is transmitted to notify the district engineer via telephone, facsimile transmission, or e-mail that they intend to provide substantive, site-specific comments. The comments must explain why the agency believes the adverse environmental effects will be more than minimal. If so contacted by an agency, the district engineer will wait an additional 15 calendar days before making a decision on the pre-construction notification. The district engineer will fully consider agency comments received within the specified time frame concerning the proposed activity's compliance with the terms and conditions of the NWPs, including the need for mitigation to ensure the net adverse environmental effects of the proposed activity are no more than minimal. The district engineer will provide no response to the resource agency, except as provided below. The district engineer will indicate in the administrative record associated with each pre-construction notification that the resource agencies' concerns were considered. For NWP 37, the emergency watershed protection and rehabilitation activity may proceed immediately in cases where there is an unacceptable hazard to life or a significant loss of property or economic hardship will occur. The district engineer will consider any comments received to decide whether the NWP 37 authorization should be modified, suspended, or revoked in accordance with the procedures at 33 CFR 330.5.

(4) In cases of where the prospective permittee is not a Federal agency, the district engineer will provide a response to NMFS within 30 calendar days of receipt of any Essential Fish Habitat conservation recommendations, as required by section 305(b)(4)(B) of the Magnuson-Stevens Fishery Conservation and Management Act.

(5) Applicants are encouraged to provide the Corps with either electronic files or multiple copies of pre-construction notifications to expedite agency coordination.

DISTRICT ENGINEER'S DECISION

1. In reviewing the PCN for the proposed activity, the district engineer will determine whether the activity authorized by the NWP will result in more than minimal

individual or cumulative adverse environmental effects or may be contrary to the public interest. If a project proponent requests authorization by a specific NWP, the district engineer should issue the NWP verification for that activity if it meets the terms and conditions of that NWP, unless he or she determines, after considering mitigation, that the proposed activity will result in more than minimal individual and cumulative adverse effects on the aquatic environment and other aspects of the public interest and exercises discretionary authority to require an individual permit for the proposed activity. For a linear project, this determination will include an evaluation of the individual crossings of waters of the United States to determine whether they individually satisfy the terms and conditions of the NWP(s), as well as the cumulative effects caused by all of the crossings authorized by NWP. If an applicant requests a waiver of the 300 linear foot limit on impacts to streams or of an otherwise applicable limit, as provided for in NWPs 13, 21, 29, 36, 39, 40, 42, 43, 44, 50, 51, 52, or 54, the district engineer will only grant the waiver upon a written determination that the NWP activity will result in only minimal individual and cumulative adverse environmental effects. For those NWPs that have a waivable 300 linear foot limit for losses of intermittent and ephemeral stream bed and a 1/2-acre limit (i.e., NWPs 21, 29, 39, 40, 42, 43, 44, 50, 51, and 52), the loss of intermittent and ephemeral stream bed, plus any other losses of jurisdictional waters and wetlands, cannot exceed 1/2-acre.

2. When making minimal adverse environmental effects determinations the district engineer will consider the direct and indirect effects caused by the NWP activity. He or she will also consider the cumulative adverse environmental effects caused by activities authorized by NWP and whether those cumulative adverse environmental effects are no more than minimal. The district engineer will also consider site specific factors, such as the environmental setting in the vicinity of the NWP activity, the type of resource that will be affected by the NWP activity, the functions provided by the aquatic resources that will be affected by the NWP activity, the degree or magnitude to which the aquatic resources perform those functions, the extent that aquatic resource functions will be lost as a result of the NWP activity (e.g., partial or complete loss), the duration of the adverse effects (temporary or permanent), the importance of the aquatic resource functions to the region (e.g., watershed or ecoregion), and mitigation required by the district engineer. If an appropriate functional or condition assessment method is available and practicable to use, that assessment method may be used by the district engineer to assist in the minimal adverse environmental effects determination. The district engineer may add case-specific special conditions to the NWP authorization to address site-specific environmental concerns.

3. If the proposed activity requires a PCN and will result in a loss of greater than 1/10-acre of wetlands, the prospective permittee should submit a mitigation proposal with the PCN. Applicants may also propose compensatory mitigation for NWP activities with smaller impacts, or for impacts to other types of waters (e.g., streams). The district engineer will consider any proposed compensatory mitigation or other mitigation measures the applicant has included in the proposal in determining whether the net adverse environmental effects of the proposed activity are no more than minimal. The compensatory mitigation proposal may be either conceptual or detailed. If the district engineer determines that the activity complies with the terms and conditions of the NWP and that the adverse environmental effects are no more than minimal, after considering mitigation, the district engineer will notify the permittee and

include any activity-specific conditions in the NWP verification the district engineer deems necessary. Conditions for compensatory mitigation requirements must comply with the appropriate provisions at 33 CFR 332.3(k). The district engineer must approve the final mitigation plan before the permittee commences work in waters of the United States, unless the district engineer determines that prior approval of the final mitigation plan is not practicable or not necessary to ensure timely completion of the required compensatory mitigation. If the prospective permittee elects to submit a compensatory mitigation plan with the PCN, the district engineer will expeditiously review the proposed compensatory mitigation plan. The district engineer must review the proposed compensatory mitigation plan within 45 calendar days of receiving a complete PCN and determine whether the proposed mitigation would ensure the NWP activity results in no more than minimal adverse environmental effects. If the net adverse environmental effects of the NWP activity (after consideration of the mitigation proposal) are determined by the district engineer to be no more than minimal, the district engineer will provide a timely written response to the applicant. The response will state that the NWP activity can proceed under the terms and conditions of the NWP, including any activity-specific conditions added to the NWP authorization by the district engineer.

4. If the district engineer determines that the adverse environmental effects of the proposed activity are more than minimal, then the district engineer will notify the applicant either: (a) that the activity does not qualify for authorization under the NWP and instruct the applicant on the procedures to seek authorization under an individual permit; (b) that the activity is authorized under the NWP subject to the applicant's submission of a mitigation plan that would reduce the adverse environmental effects so that they are no more than minimal; or (c) that the activity is authorized under the NWP with specific modifications or conditions. Where the district engineer determines that mitigation is required to ensure no more than minimal adverse environmental effects, the activity will be authorized within the 45-day PCN period (unless additional time is required to comply with general conditions 18, 20, and/or 31, or to evaluate PCNs for activities authorized by NWPs 21, 49, and 50), with activity-specific conditions that state the mitigation requirements. The authorization will include the necessary conceptual or detailed mitigation plan or a requirement that the applicant submit a mitigation plan that would reduce the adverse environmental effects so that they are no more than minimal. When compensatory mitigation is required, no work in waters of the United States may occur until the district engineer has approved a specific mitigation plan or has determined that prior approval of a final mitigation plan is not practicable or not necessary to ensure timely completion of the required compensatory mitigation.

FURTHER INFORMATION

1. District Engineers have authority to determine if an activity complies with the terms and conditions of an NWP.
2. NWPs do not obviate the need to obtain other federal, state, or local permits, approvals, or authorizations required by law.
3. NWPs do not grant any property rights or exclusive privileges.
4. NWPs do not authorize any injury to the property or rights of others.
5. NWPs do not authorize interference with any existing or proposed Federal project (see general condition 31).

DEFINITIONS

Best management practices (BMPs): Policies, practices, procedures, or structures implemented to mitigate the adverse environmental effects on surface water quality resulting from development. BMPs are categorized as structural or non-structural.

Compensatory mitigation: The restoration (re-establishment or rehabilitation), establishment (creation), enhancement, and/or in certain circumstances preservation of aquatic resources for the purposes of offsetting unavoidable adverse impacts which remain after all appropriate and practicable avoidance and minimization has been achieved.

Currently serviceable: Useable as is or with some maintenance, but not so degraded as to essentially require reconstruction.

Direct effects: Effects that are caused by the activity and occur at the same time and place.

Discharge: The term “discharge” means any discharge of dredged or fill material into waters of the United States.

Ecological reference: A model used to plan and design an aquatic habitat and riparian area restoration, enhancement, or establishment activity under NWP 27. An ecological reference may be based on the structure, functions, and dynamics of an aquatic habitat type or a riparian area type that currently exists in the region where the proposed NWP 27 activity is located. Alternatively, an ecological reference may be based on a conceptual model for the aquatic habitat type or riparian area type to be restored, enhanced, or established as a result of the proposed NWP 27 activity. An ecological reference takes into account the range of variation of the aquatic habitat type or riparian area type in the region.

Enhancement: The manipulation of the physical, chemical, or biological characteristics of an aquatic resource to heighten, intensify, or improve a specific aquatic resource function(s). Enhancement results in the gain of selected aquatic resource function(s), but may also lead to a decline in other aquatic resource function(s). Enhancement does not result in a gain in aquatic resource area.

Ephemeral stream: An ephemeral stream has flowing water only during, and for a short duration after, precipitation events in a typical year. Ephemeral stream beds are located above the water table year-round. Groundwater is not a source of water for the stream. Runoff from rainfall is the primary source of water for stream flow.

Establishment (creation): The manipulation of the physical, chemical, or biological characteristics present to develop an aquatic resource that did not previously exist at an upland site. Establishment results in a gain in aquatic resource area.

High Tide Line: The line of intersection of the land with the water’s surface at the maximum height reached by a rising tide. The high tide line may be determined, in the absence of actual data, by a line of oil or scum along shore objects, a more or less continuous deposit of fine shell or debris on the foreshore or berm, other physical markings or characteristics, vegetation lines, tidal gages, or other suitable means that delineate the general height reached by a rising tide. The line encompasses spring high tides and other high tides that occur with periodic frequency but does not include storm surges in which there is a departure from the normal or predicted reach of the tide due to the piling up of water against a coast by strong winds such as those accompanying a hurricane or other intense storm.

Historic Property: Any prehistoric or historic district, site (including archaeological site), building, structure, or other object included in, or eligible for inclusion in, the National

Register of Historic Places maintained by the Secretary of the Interior. This term includes artifacts, records, and remains that are related to and located within such properties. The term includes properties of traditional religious and cultural importance to an Indian tribe or Native Hawaiian organization and that meet the National Register criteria (36 CFR part 60).

Independent utility: A test to determine what constitutes a single and complete non-linear project in the Corps Regulatory Program. A project is considered to have independent utility if it would be constructed absent the construction of other projects in the project area. Portions of a multi-phase project that depend upon other phases of the project do not have independent utility. Phases of a project that would be constructed even if the other phases were not built can be considered as separate single and complete projects with independent utility.

Indirect effects: Effects that are caused by the activity and are later in time or farther removed in distance, but are still reasonably foreseeable.

Intermittent stream: An intermittent stream has flowing water during certain times of the year, when groundwater provides water for stream flow. During dry periods, intermittent streams may not have flowing water. Runoff from rainfall is a supplemental source of water for stream flow.

Loss of waters of the United States: Waters of the United States that are permanently adversely affected by filling, flooding, excavation, or drainage because of the regulated activity. Permanent adverse effects include permanent discharges of dredged or fill material that change an aquatic area to dry land, increase the bottom elevation of a waterbody, or change the use of a waterbody. The acreage of loss of waters of the United States is a threshold measurement of the impact to jurisdictional waters for determining whether a project may qualify for an NWP; it is not a net threshold that is calculated after considering compensatory mitigation that may be used to offset losses of aquatic functions and services. The loss of stream bed includes the acres or linear feet of stream bed that are filled or excavated as a result of the regulated activity. Waters of the United States temporarily filled, flooded, excavated, or drained, but restored to pre-construction contours and elevations after construction, are not included in the measurement of loss of waters of the United States. Impacts resulting from activities that do not require Department of the Army authorization, such as activities eligible for exemptions under section 404(f) of the Clean Water Act, are not considered when calculating the loss of waters of the United States.

Navigable waters: Waters subject to section 10 of the Rivers and Harbors Act of 1899. These waters are defined at 33 CFR part 329.

Non-tidal wetland: A non-tidal wetland is a wetland that is not subject to the ebb and flow of tidal waters. Non-tidal wetlands contiguous to tidal waters are located landward of the high tide line (i.e., spring high tide line).

Open water: For purposes of the NWPs, an open water is any area that in a year with normal patterns of precipitation has water flowing or standing above ground to the extent that an ordinary high water mark can be determined. Aquatic vegetation within the area of flowing or standing water is either non-emergent, sparse, or absent. Vegetated shallows are considered to be open waters. Examples of "open waters" include rivers, streams, lakes, and ponds.

Ordinary High Water Mark: An ordinary high water mark is a line on the shore established by the fluctuations of water and indicated by physical characteristics, or by other appropriate means that consider the characteristics of the surrounding areas.

Perennial stream: A perennial stream has flowing water year-round during a typical year. The water table is located above the stream bed for most of the year. Groundwater is the

primary source of water for stream flow. Runoff from rainfall is a supplemental source of water for stream flow.

Practicable: Available and capable of being done after taking into consideration cost, existing technology, and logistics in light of overall project purposes.

Pre-construction notification: A request submitted by the project proponent to the Corps for confirmation that a particular activity is authorized by nationwide permit. The request may be a permit application, letter, or similar document that includes information about the proposed work and its anticipated environmental effects. Pre-construction notification may be required by the terms and conditions of a nationwide permit, or by regional conditions. A pre-construction notification may be voluntarily submitted in cases where pre-construction notification is not required and the project proponent wants confirmation that the activity is authorized by nationwide permit.

Preservation: The removal of a threat to, or preventing the decline of, aquatic resources by an action in or near those aquatic resources. This term includes activities commonly associated with the protection and maintenance of aquatic resources through the implementation of appropriate legal and physical mechanisms. Preservation does not result in a gain of aquatic resource area or functions.

Protected tribal resources: Those natural resources and properties of traditional or customary religious or cultural importance, either on or off Indian lands, retained by, or reserved by or for, Indian tribes through treaties, statutes, judicial decisions, or executive orders, including tribal trust resources.

Re-establishment: The manipulation of the physical, chemical, or biological characteristics of a site with the goal of returning natural/historic functions to a former aquatic resource. Re-establishment results in rebuilding a former aquatic resource and results in a gain in aquatic resource area and functions.

Rehabilitation: The manipulation of the physical, chemical, or biological characteristics of a site with the goal of repairing natural/historic functions to a degraded aquatic resource. Rehabilitation results in a gain in aquatic resource function, but does not result in a gain in aquatic resource area.

Restoration: The manipulation of the physical, chemical, or biological characteristics of a site with the goal of returning natural/historic functions to a former or degraded aquatic resource. For the purpose of tracking net gains in aquatic resource area, restoration is divided into two categories: re-establishment and rehabilitation.

Riffle and pool complex: Riffle and pool complexes are special aquatic sites under the 404(b)(1) Guidelines. Riffle and pool complexes sometimes characterize steep gradient sections of streams. Such stream sections are recognizable by their hydraulic characteristics. The rapid movement of water over a coarse substrate in riffles results in a rough flow, a turbulent surface, and high dissolved oxygen levels in the water. Pools are deeper areas associated with riffles. A slower stream velocity, a streaming flow, a smooth surface, and a finer substrate characterize pools.

Riparian areas: Riparian areas are lands next to streams, lakes, and estuarine- marine shorelines. Riparian areas are transitional between terrestrial and aquatic ecosystems, through which surface and subsurface hydrology connects riverine, lacustrine, estuarine, and marine waters with their adjacent wetlands, non-wetland waters, or uplands. Riparian areas provide a variety of ecological functions and services and help improve or maintain local water quality. (See general condition 23.)

Shellfish seeding: The placement of shellfish seed and/or suitable substrate to increase shellfish production. Shellfish seed consists of immature individual shellfish or individual shellfish attached to shells or shell fragments (i.e., spat on shell). Suitable substrate may consist of shellfish shells, shell fragments, or other appropriate materials placed into waters for shellfish habitat.

Single and complete linear project: A linear project is a project constructed for the purpose of getting people, goods, or services from a point of origin to a terminal point, which often involves multiple crossings of one or more waterbodies at separate and distant locations. The term “single and complete project” is defined as that portion of the total linear project proposed or accomplished by one owner/developer or partnership or other association of owners/developers that includes all crossings of a single water of the United States (i.e., a single waterbody) at a specific location. For linear projects crossing a single or multiple waterbodies several times at separate and distant locations, each crossing is considered a single and complete project for purposes of NWP authorization. However, individual channels in a braided stream or river, or individual arms of a large, irregularly shaped wetland or lake, etc., are not separate waterbodies, and crossings of such features cannot be considered separately.

Single and complete non-linear project: For non-linear projects, the term “single and complete project” is defined at 33 CFR 330.2(i) as the total project proposed or accomplished by one owner/developer or partnership or other association of owners/developers. A single and complete non-linear project must have independent utility (see definition of “independent utility”). Single and complete non-linear projects may not be “piecemealed” to avoid the limits in an NWP authorization.

Stormwater management: Stormwater management is the mechanism for controlling stormwater runoff for the purposes of reducing downstream erosion, water quality degradation, and flooding and mitigating the adverse effects of changes in land use on the aquatic environment.

Stormwater management facilities: Stormwater management facilities are those facilities, including but not limited to, stormwater retention and detention ponds and best management practices, which retain water for a period of time to control runoff and/or improve the quality (i.e., by reducing the concentration of nutrients, sediments, hazardous substances and other pollutants) of stormwater runoff.

Stream bed: The substrate of the stream channel between the ordinary high water marks. The substrate may be bedrock or inorganic particles that range in size from clay to boulders. Wetlands contiguous to the stream bed, but outside of the ordinary high water marks, are not considered part of the stream bed.

Stream channelization: The manipulation of a stream’s course, condition, capacity, or location that causes more than minimal interruption of normal stream processes. A channelized stream remains a water of the United States.

Structure: An object that is arranged in a definite pattern of organization. Examples of structures include, without limitation, any pier, boat dock, boat ramp, wharf, dolphin, weir, boom, breakwater, bulkhead, revetment, riprap, jetty, artificial island, artificial reef, permanent mooring structure, power transmission line, permanently moored floating vessel, piling, aid to navigation, or any other manmade obstacle or obstruction.

Tidal wetland: A tidal wetland is a jurisdictional wetland that is inundated by tidal waters. Tidal waters rise and fall in a predictable and measurable rhythm or cycle due to the gravitational pulls of the moon and sun. Tidal waters end where the rise and fall of the water

surface can no longer be practically measured in a predictable rhythm due to masking by other waters, wind, or other effects. Tidal wetlands are located channelward of the high tide line.

Tribal lands: Any lands title to which is either: 1) held in trust by the United States for the benefit of any Indian tribe or individual; or 2) held by any Indian tribe or individual subject to restrictions by the United States against alienation.

Tribal rights: Those rights legally accruing to a tribe or tribes by virtue of inherent sovereign authority, unextinguished aboriginal title, treaty, statute, judicial decisions, executive order or agreement, and that give rise to legally enforceable remedies.

Vegetated shallows: Vegetated shallows are special aquatic sites under the 404(b)(1) Guidelines. They are areas that are permanently inundated and under normal circumstances have rooted aquatic vegetation, such as seagrasses in marine and estuarine systems and a variety of vascular rooted plants in freshwater systems.

Waterbody: For purposes of the NWPs, a waterbody is a jurisdictional water of the United States. If a wetland is adjacent to a waterbody determined to be a water of the United States, that waterbody and any adjacent wetlands are considered together as a single aquatic unit (see 33 CFR 328.4(c)(2)). Examples of “waterbodies” include streams, rivers, lakes, ponds, and wetlands.

FINAL 2017 REGIONAL CONDITIONS

NOTICE ABOUT WEB LINKS IN THIS DOCUMENT:

The web links (both internal to our Wilmington District and any external links to collaborating agencies) in this document are valid at the time of publication. However, the Wilmington District Regulatory Program web page addresses, as with other agency web sites, may change over the timeframe of the five-year Nationwide Permit renewal cycle, in response to policy mandates or technology advances. While we will make every effort to check on the integrity of our web links and provide re-direct pages whenever possible, we ask that you report any broken links to us so we can keep the page information current and usable. We apologize in advanced for any broken links that you may encounter, and we ask that you navigate from the Regulatory home page (Regulatory Permit Program Wetlands and Streams) of the Wilmington District Corps of Engineers, to the “Permits” section of our web site to find links for pages that cannot be found by clicking directly on the listed web link in this document.

Final 2017 Regional Conditions for Nationwide Permits (NWP) in the Wilmington District

1.0 Excluded Waters

The Corps has identified waters that will be excluded from the use of all NWP’s during certain timeframes. These waters are:

1.1 Anadromous Fish Spawning Areas

Waters of the United States identified by either the North Carolina Division of Marine Fisheries (NCDMF) or the North Carolina Wildlife Resources Commission (NCWRC) as anadromous fish spawning areas are excluded during the period between February 15 and June 30, without prior written approval from the Corps and either NCDMF or NCWRC.

1.2 Trout Waters Moratorium

Waters of the United States in the designated trout watersheds of North Carolina are excluded during the period between October 15 and April 15 without prior written approval from the NCWRC, or from the Eastern Band of Cherokee Indians (EBCI) Fisheries and Wildlife Management (FWM) office if the project is located on EBCI trust land. (See Section 2.7 for information on the designated trout watersheds).

1.3 Sturgeon Spawning Areas as Designated by the National Marine Fisheries Service (NMFS)

Waters of the United States designated as sturgeon spawning areas are excluded during the period between February 1 and June 30, without prior written approval from the NMFS.

2.0 Waters Requiring Additional Notification

The Corps has identified waters that will be subject to additional notification requirements for activities authorized by all NWPs. These waters are:

2.1 Western NC Counties that Drain to Designated Critical Habitat

For proposed activities within waters of the United States that require a Pre-Construction Notification (PCN) and are located in the sixteen counties listed below, permittees must provide a copy of the PCN to the U.S. Fish and Wildlife Service (USFWS), 160 Zillicoa Street, Asheville, North Carolina 28801. This PCN must be sent concurrently to the U.S. Fish and Wildlife Service and the Corps Asheville Regulatory Field Office. Please see General Condition 18 for specific notification requirements related to the Endangered Species Act and the below website for information on the location of designated critical habitat.

Counties with tributaries that drain to designated critical habitat that require notification to the Asheville U.S. Fish and Wildlife Service: Avery, Cherokee, Forsyth, Graham, Haywood, Henderson, Jackson, Macon, Mecklenburg, Mitchell, Stokes, Surry, Swain, Transylvania, Union and Yancey.

Website and office addresses for Endangered Species Act Information:

The Wilmington District has developed the following website for permittees which provides guidelines on how to review linked websites and maps in order to fulfill NWP General Condition 18 requirements:

<http://www.saw.usace.army.mil/Missions/RegulatoryPermitProgram/AgencyCoordination/ESA.asp>

Permittees who do not have internet access may contact the appropriate U.S. Fish and Wildlife Service offices listed below or Corps at (910) 251-4633:

Asheville U.S. Fish and Wildlife Service Office counties: All counties west of and including Anson, Stanly, Davidson, Forsythe and Stokes Counties.

U.S. Fish and Wildlife Service
Asheville Field Office
160 Zillicoa Street
Asheville, NC 28801
Telephone: (828) 258-3939

Raleigh U.S. Fish and Wildlife Service Office counties: all counties east of and including Richmond, Montgomery, Randolph, Guilford, and Rockingham Counties.

U.S. Fish and Wildlife Service
Raleigh Field Office
Post Office Box 33726

Raleigh, NC 27636-3726
Telephone: (919) 856-4520

2.2 Special Designation Waters

Prior to the use of any NWP, except NWP 3, that involves a discharge of dredged or fill material in any of the following identified waters and/or adjacent wetlands in North Carolina, permittees shall submit a PCN to the District Engineer prior to commencing the activity (see General Condition 32). The North Carolina waters and wetlands that require additional notification requirements are:

“Outstanding Resource Waters” (ORW) or “High Quality Waters” (HQW) as designated by the North Carolina Environmental Management Commission; “Primary Nursery Areas” (PNA), including inland PNA, as designated by the North Carolina Marine Fisheries Commission and the NCWRC; or wetlands adjacent to these waters. Definitions of ORW, HQW and PNA waters can be found in the North Carolina State Administrative Code, Title 15A, Subchapters 2B and 10C (15A NCAC 02B, 15A NCAC 10C) and at the following World Wide Web page: <http://reports.oah.state.nc.us/ncac.asp?folderName=\Title%2015A%20-%20Environmental%20Quality&lookupError=15A%20NCAC%20000%20>. Surface water classifications for waters in North Carolina can be viewed at the North Carolina Division of Water Resources website or at the following World Wide Web Page: <https://deq.nc.gov/about/divisions/water-resources/planning/classification-standards/classifications>

Permittees who do not have internet access may contact the Corps at (910) 251- 4633.

2.3 Coastal Area Management Act (CAMA) Areas of Environmental Concern

Non-federal permittees for any NWP in a designated “Area of Environmental Concern” (AEC) in the twenty (20) counties of Eastern North Carolina covered by the North Carolina Coastal Area Management Act (CAMA) must also obtain the required CAMA permit. Development activities for non-federal projects may not commence until a copy of the approved CAMA permit is furnished to the appropriate Wilmington District Regulatory Field Office (Wilmington Field Office – 69 Darlington Avenue, Wilmington, NC 28403, (910) 251-4802 or Washington Field Office – 2407 West 5th Street, Washington, NC 27889, (910) 251-4610).

2.4 Barrier Islands

Prior to the use of any NWP on a barrier island of North Carolina, permittees must submit a PCN to the District Engineer prior to commencing the activity (see General Condition 32).

2.5 Mountain or Piedmont Bogs

Prior to the use of any NWP in a Bog, as classified by the North Carolina Wetland Assessment Methodology (NCWAM), permittees shall submit a PCN to the District Engineer prior to commencing the activity (see General Condition 32). The latest version of NCWAM can be

viewed on the Corps RIBITS (Regulatory In-lieu Fee and Bank Information Tracking System) website or at the following World Wide Web Page:
https://ribits.usace.army.mil/ribits_apex/f?p=107:27:0::NO::

2.6 Animal Waste Facilities

Prior to use of any NWP for construction of animal waste facilities in waters of the United States, including wetlands, permittees shall submit a PCN to the District Engineer prior to commencing the activity (see General Condition 32).

2.7 Trout Waters

Prior to any discharge of dredge or fill material into streams, waterbodies or wetlands within the 294 designated trout watersheds of North Carolina, the permittee shall submit a PCN (see General Condition 32) to the District Engineer prior to commencing the activity, unless other thresholds are established in the Regional Conditions in Section 4 (Additional Regional Conditions for Specific Nationwide Permits). The permittee shall also provide a copy of the notification to the appropriate NCWRC office, or to the EBCI FWM Office (if the project is located on EBCI trust land), to facilitate the determination of any potential impacts to designated Trout Waters.

Notification to the Corps will include a statement with the name of the NCWRC or EBCI FWM biologist contacted, the date of the notification, the location of work, a delineation of wetlands and waters, a discussion of alternatives to working in the mountain trout waters, why alternatives were not selected, and, if applicable, a plan to provide compensatory mitigation for all unavoidable adverse impacts to mountain trout waters.

NCWRC and NC Trout Watersheds:

NCWRC Contact**	Counties that are entirely within Trout Watersheds*	Counties that are partially within Trout Watersheds*
Mountain Coordinator Balsam Depot 20830 Great Smoky Mountain Expressway Waynesville, NC 28786 Telephone: (828) 558-6011 For NCDOT Projects: NCDOT Coordinator 206 Charter. Street Albemarle, NC 28001 Telephone: (704) 982-9181	Alleghany Jackson Ashe Macon Avery Swain Graham Transylvania Haywood Watauga	Burke McDowell Buncombe Mitchell Caldwell Polk Cherokee Rutherford Clay Surry Henderson Wilkes Madison Yancey

*NOTE: To determine notification requirements, contact the Corps Asheville Regulatory Field Office at (828) 271-7980 or view maps for each County at the following World Wide Web page: <http://www.saw.usace.army.mil/Missions/Regulatory-Permit-Program/Agency-Coordination/Trout/>.

**If a project is located on EBCI trust land, submit the PCN in accordance with Section 3.14. Contact the Corps Asheville Regulatory Field Office at (828) 271-7980 with questions.

2.8 Western NC Waters and Corridors

The permittee shall submit a PCN (see General Condition 32) to the District Engineer prior to commencing the activity in waters of the United States if the activity will occur within any of the following identified waters in western North Carolina, within 0.5 mile on either side of these waters, or within 0.75 mile of the Little Tennessee River, as measured from the top of the bank of the respective water (i.e., river, stream, or creek):

Brasstown Creek
Burningtown Creek
Cane River
Caney Fork
Cartoogechaye Creek
Chattooga River
Cheoah River
Cowee Creek
Cullasaja River
Deep Creek
Ellijay Creek
French Broad River
Garden Creek
Hiwassee River
Hominy Creek
Iotla Creek
Little Tennessee River (within the river or within 0.75 mile on either side of this river)
Nantahala River
Nolichucky River
North Fork French Broad River
North Toe River
Nottley River
Oconaluftee River (portion not located on trust/EBCI land)
Peachtree Creek
Shooting Creek
Snowbird Creek
South Toe River
Stecoah Creek
Swannanoa River
Sweetwater Creek

Tuckasegee River (also spelled Tuckaseegee or Tuckaseigee)
Valley River
Watauga Creek
Watauga River
Wayah Creek
West Fork French Broad River

To determine notification requirements, contact the Corps Asheville Regulatory Field Office at (828) 271-7980 or view maps for all corridors at the following World Wide Web page:
<http://www.saw.usace.army.mil/Missions/Regulatory-Permit-Program/Agency-Coordination/Designated-Special-Waters.aspx>

3.0 List of Corps Regional Conditions for All Nationwide Permits

The following conditions apply to all Nationwide Permits in the Wilmington District:

3.1 Limitation of Loss of Stream Bed

NWPs may not be used for activities that may result in the loss or degradation of more than 300 total linear feet of stream bed, unless the District Engineer has waived the 300 linear foot limit for ephemeral and intermittent streams on a case-by-case basis and has determined that the proposed activity will result in minimal individual and cumulative adverse impacts to the aquatic environment. Waivers for the loss of ephemeral and intermittent streams must be in writing and documented by appropriate/accepted stream quality assessments*. This waiver only applies to the 300 linear feet threshold for NWPs.

This Regional Condition does not apply to NWP 23 (Approved Categorical Exclusions).

*NOTE: Permittees should utilize the most current methodology prescribed by Wilmington District to assess stream function and quality. Information can be found at:
https://ribits.usace.army.mil/ribits_apex/f?p=107:27:0::NO::

3.2 Mitigation for Loss of Stream Bed

For any NWP that results in a loss of more than 150 linear feet of stream, the permittee shall provide a mitigation proposal to compensate for more than minimal individual and cumulative adverse impacts to the aquatic environment. For stream losses of 150 linear feet or less that require a PCN, the District Engineer may determine, on a case-by-case basis, that compensatory mitigation is required to ensure that the activity results in minimal adverse effect on the aquatic environment.

3.3 Pre-construction Notification for Loss of Streambed Exceeding 150 Feet

Prior to use of any NWP for any activity which impacts more than 150 total linear feet of perennial stream, intermittent or ephemeral stream, the permittee shall submit a PCN to the District Engineer prior to commencing the activity (see General Condition 32). This applies to

NWPs that do not have specific notification requirements. If a NWP has specific notification requirements, the requirements of the NWP should be followed.

3.4 Restriction on Use of Live Concrete

For all NWPs which allow the use of concrete as a building material, live or fresh concrete, including bags of uncured concrete, may not come into contact with the water in or entering into waters of the United States. Water inside coffer dams or casings that has been in contact with wet concrete shall only be returned to waters of the United States after the concrete is set and cured and when it no longer poses a threat to aquatic organisms.

3.5 Requirements for Using Riprap for Bank Stabilization

For all NWPs that allow for the use of riprap material for bank stabilization, the following measures shall be applied:

3.5.1. Where bank stabilization is conducted as part of an activity, natural design, bioengineering and/or geoen지니어ing methods that incorporate natural durable materials, native seed mixes, and native plants and shrubs are to be utilized to the maximum extent practicable.

3.5.2. Filter cloth must be placed underneath the riprap as an additional requirement of its use in North Carolina waters. The placement of filter fabric is not required if the riprap will be pushed or “keyed” into the bank of the waterbody. A waiver from the specifications in this Regional Condition may be requested in writing. The waiver will only be issued if it can be demonstrated that the impacts of complying with this Regional Condition would result in greater adverse impacts to the aquatic environment.

3.5.3. The placement of riprap shall be limited to the areas depicted on submitted work plan drawings.

3.5.4. The riprap material shall be clean and free from loose dirt or any pollutant except in trace quantities that would not have an adverse environmental effect.

3.5.5. It shall be of a size sufficient to prevent its movement from the authorized alignment by natural forces under normal conditions.

3.5.6. The riprap material shall consist of clean rock or masonry material such as, but not limited to, granite, marl, or broken concrete.

3.6 Requirements for Culvert Placement

3.6.1 For all NWPs that involve the construction/installation of culverts, measures will be included in the construction/installation that will promote the safe passage of fish and other aquatic organisms. The dimension, pattern, and profile of the stream above and below a pipe or culvert should not be modified by altering the width or depth of the stream profile in connection with the construction activity. The width, height, and gradient of a proposed culvert should be

sufficient to pass the average historical low flow and spring flow without adversely altering flow velocity. Spring flow is the seasonal sustained high flow that typically occurs in the spring. Spring flows should be determined from gage data, if available. In the absence of such data, bank-full flow can be used as a comparable indicator.

In Public Trust Areas of Environmental Concern (AEC) and/or the Estuarine Waters AEC as designated by the Coastal Area Management Act (CAMA): All pipes/culverts must be sufficiently sized to allow for the burial of the bottom of the culvert at least one foot below normal bed elevation.

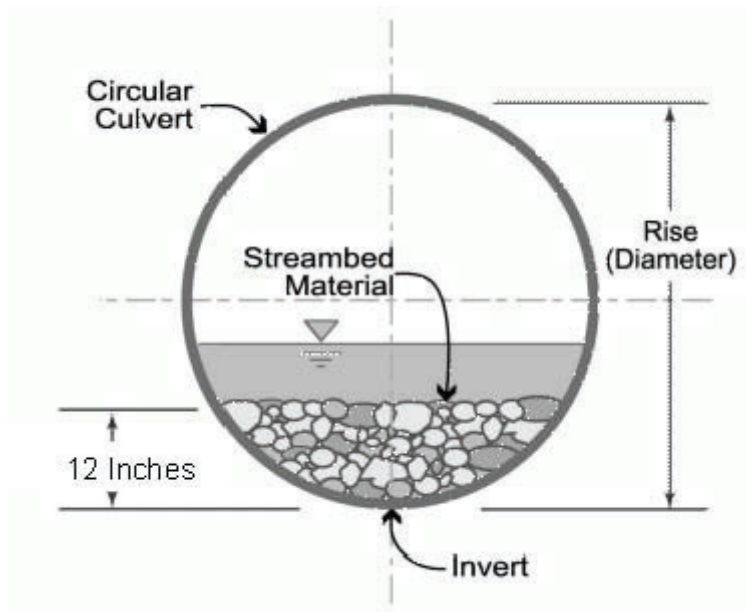

In all other areas: Culverts greater than 48 inches in diameter will be buried at least one foot below the bed of the stream. Culverts 48 inches in diameter or less shall be buried to maintain aquatic passage and to maintain passage during drought or low flow conditions, and every effort shall be made to maintain the existing channel slope.

Culverts must be designed and constructed in a manner that minimizes destabilization and head cutting. Destabilizing the channel and head cutting upstream should be considered and appropriate actions incorporated in the design and placement of the culvert.

A waiver from the depth specifications in this condition may be requested, in writing, by the permittee and issued by the Corp; this request must be specific as to the reason(s) for the request. The waiver will be issued if it can be demonstrated that the proposed design would result in less impacts to the aquatic environment.

All counties: Culverts placed within riparian and/or riverine wetlands must be installed in a manner that does not restrict the flow and circulation patterns of waters of the United States.

Culverts placed across wetland fills purely for the purposes of equalizing surface water do not have to be buried, but the culverts must be of adequate size and/or number to ensure unrestricted transmission of water.

3.6.2 Bank-full flows (or less) shall be accommodated through maintenance of the existing bank-full channel cross sectional area. Additional culverts or culvert barrels at such crossings shall be allowed only to receive bank-full flows.

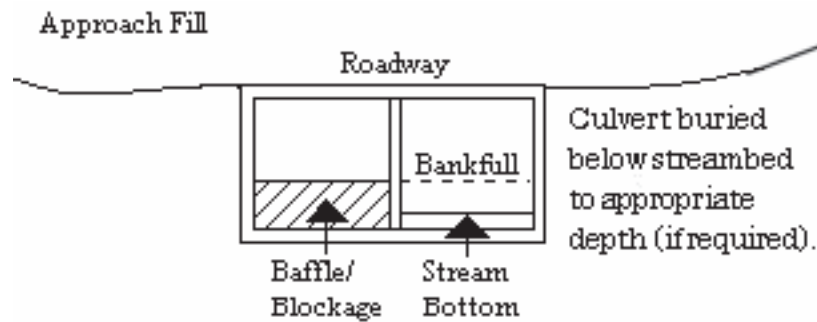

3.6.3 Where adjacent floodplain is available, flows exceeding bank-full should be accommodated by installing culverts at the floodplain elevation. Additional culverts or culvert barrels at such crossings should not be buried, or if buried, must have sills at the inlets to ensure that they only receive flows exceeding bank-full.

3.6.4 Excavation of existing stream channels shall be limited to the minimum necessary to construct or install the proposed culvert. The final width of the impacted stream at the culvert inlet and outlet should be no greater than the original stream width. A waiver from this condition may be requested in writing; this request must be specific as to the reason(s) for the request. The waiver will be issued if the proposed design would result in less impacts to the aquatic environment and/or if it can be demonstrated that it is not practicable to restore the final width of the impacted stream at the culvert inlet and outlet to the width of the original stream channel.

3.6.5 The width of the culvert shall be comparable to the width of the stream channel. If the width of the culvert is wider than the stream channel, the culvert shall include baffles, benches and/or sills to maintain the width of the stream channel. A waiver from this condition may be requested in writing; this request must be specific as to the reason(s) for the request. The waiver will be issued if it can be demonstrated that it is not practicable or necessary to include baffles, benches or sills and the design would result in less impacts to the aquatic environment.

3.7 Notification to NCDEQ Shellfish Sanitation Section

Permittees shall notify the NCDEQ Shellfish Sanitation Section prior to dredging in or removing sediment from an area closed to shell fishing where the effluent may be released to an area open for shell fishing or swimming in order to avoid contamination from the disposal area and cause a temporary shellfish closure to be made. Such notification shall also be provided to the appropriate Corps Regulatory Field Office. Any disposal of sand to the ocean beach should occur between November 1 and April 30 when recreational usage is low. Only clean sand

should be used and no dredged sand from closed shell fishing areas may be used. If beach disposal were to occur at times other than stated above or if sand from a closed shell fishing area is to be used, a swimming advisory shall be posted, and a press release shall be issued by the permittee.

3.8 Submerged Aquatic Vegetation

Impacts to Submerged Aquatic Vegetation (SAV) are not authorized by any NWP, except NWP 48, unless EFH Consultation has been completed pursuant to the Magnuson-Stevens Fisheries Conservation and Management Act (Magnuson-Stevens Act). Permittees shall submit a PCN (See NWP General Condition 32) to the District Engineer prior to commencing the activity if the project would affect SAV. The permittee may not begin work until notified by the Corps that the requirements of the Magnuson-Stevens Act have been satisfied and that the activity is authorized.

3.9 Sedimentation and Erosion Control Structures and Measures

All PCNs will identify and describe sedimentation and erosion control structures and measures proposed for placement in waters of the United States. The structures and measures should be depicted on maps, surveys or drawings showing location and impacts to jurisdictional wetlands and streams.

3.10 Restoration of Temporary Impacts to Stream Beds

Upon completion of work that involves temporary stream impacts, streambeds are to be restored to pre-project elevations and widths using natural streambed material such that the impacted stream reach mimics the adjacent upstream and downstream reach. The impacted area shall be backfilled with natural streambed material to a depth of at least 12 inches or to the bottom depth of the impacted area if shallower than 12 inches. An engineered in-stream structure or material can be used to provide protection of a buried structure if it provides benefits to the aquatic environment and can be accomplished by a natural streambed design. A permittee may request a waiver of this condition if it is determined a buried structure needs significant physical protection beyond those provided in this condition. This condition does not apply to NWP 27 – Aquatic Habitat Restoration, Enhancement, and Establishment Activities.

3.11 Restoration of Temporary Impacts to Stream Banks

Upon completion of work involving temporary stream bank impacts, stream banks are to be restored to pre-project grade and contours or beneficial grade and contours if the original bank slope is steep and unstable. Natural durable materials, native seed mixes, and native plants and shrubs are to be utilized in the restoration. Natural designs which use bioengineered and/or geo-engineered methods are to be applied. An engineered structure or material can be used to provide protection of a buried structure if it provides benefits to the stream bank environment, provided it is not in excess of the minimum amount needed for protection and does not exceed an average of one cubic yard per running foot placed along the bank below the plane of the ordinary high water mark. A permittee may request a waiver of this condition if it is determined a buried structure

needs significant physical protection beyond those provided in this condition. This condition does not apply to NWP 27 – Aquatic Habitat Restoration, Enhancement, and Establishment Activities.

3.12 Federal Navigation Channel Setbacks and Corps Easements

3.12.1 Authorized structures and fills located in or adjacent to Federally authorized waterways will be constructed in accordance with the latest setback criteria established by the Wilmington District Engineer. You may review the setback policy at <http://www.saw.usace.army.mil/Missions/Navigation/Setbacks.aspx>. This general permit does not authorize the construction of hardened or permanently fixed structures within the Federally Authorized Channel Setback, unless the activity is approved by the Corps. The permittee shall submit a PCN (see General Condition 32) to the District Engineer prior to the construction of any structures or fills within the Federally Authorized Channel Setback.

3.12.2 The permittee shall obtain a Consent to Cross Government Easement from the Wilmington District’s Land Use Coordinator prior to any crossing of the Corps easement and/or prior to commencing construction of any structures, authorized dredging or other work within the right-of-way of, or in proximity to, a federally designated disposal area. The Land Use Coordinator may be contacted at: CESA-W-OP-N, 69 Darlington Avenue, Wilmington, North Carolina 28403-1343, email: SAWWeb-NAV@usace.army.mil

3.13 Northern Long-eared Bat – Endangered Species Act Compliance

The Wilmington District, U.S. Army Corps of Engineers has consulted with the United States Fish and Wildlife Service (USFWS) in regards to the threatened Northern long-eared bat (NLEB) (*Myotis septentrionalis*) and Standard Local Operating Procedures for Endangered Species (SLOPES) have been approved by the Corps and the USFWS. This condition concerns effects to the NLEB only and does not address effects to other federally listed species and/or federally designated critical habitat.

A. Procedures when the Corps is the lead federal* agency for a project:

The permittee must comply with (1) and (2) below when:

- the project is located in the western 41 counties of North Carolina, to include non-federal aid North Carolina Department of Transportation (NCDOT) projects, OR;
- the project is located in the 59 eastern counties of North Carolina, and is a non-NCDOT project.

*Generally, if a project is located on private property or on non-federal land, and the project is not being funded by a federal entity, the Corps will be the lead federal agency due to the requirement to obtain Department of the Army authorization to impact waters of the United States. If the project is located on federal land, contact the Corps to determine the lead federal agency.

(1) A permittee using a NWP must check to see if their project is located in the range of the NLEB by using the following website:

<http://www.fws.gov/midwest/endangered/mammals/nleb/pdf/WNSZone.pdf>. If the project is within the range of the NLEB, or if the project includes percussive activities (e.g., blasting, pile driving, etc.), the permittee is then required to check the appropriate website in the paragraph below to discover if their project:

- is located in a 12-digit Hydrologic Unit Code area (“red HUC” - shown as red areas on the map), AND/OR;
- involves percussive activities within 0.25 mile of a red HUC.

Red HUC maps - for the western 41 counties in NC (covered by the Asheville Ecological Services Field Office), check the project location against the electronic maps found at: http://www.fws.gov/asheville/htmls/project_review/NLEB_in_WNC.html. For the eastern 59 counties in NC (covered by the Raleigh Ecological Services Field Office), check the project location against the electronic maps found at: https://www.fws.gov/raleigh/NLEB_RFO.html.

(2) A permittee must submit a PCN to the District Engineer, and receive written authorization from the District Engineer, prior to commencing the activity, if the activity will involve any of the following:

- tree clearing/removal, construction/installation of wind turbines in a red HUC, AND/OR;
- bridge removal or maintenance, unless the bridge has been inspected and there is no evidence of bat use, (applies anywhere in the range of the NLEB), AND/OR;
- percussive activities in a red HUC, or within 0.25 mile of a red HUC.

The permittee may proceed with the activity without submitting a PCN to either the Corps or the USFWS, provided the activity complies with all applicable NWP terms and general and regional conditions, if the permittee’s review under A.(1) and A.(2) above shows that the project is:

- located outside of a red HUC (and there are no percussive activities), and the activity will NOT include bridge removal or maintenance, unless the bridge has been inspected and there is no evidence of bat use, OR;
- located outside of a red HUC and there are percussive activities, but the percussive activities will not occur within 0.25-mile of a red HUC boundary, and the activity will NOT include bridge removal or maintenance, unless the bridge has been inspected and there is no evidence of bat use, OR;

- located in a red HUC, but the activity will NOT include: tree clearing/removal; construction/installation of wind turbines; bridge removal or maintenance, unless the bridge has been inspected and there is no evidence of bat use, and/or; any percussive activities.

B. Procedures when the USACE is not the lead federal agency:

For projects where another federal agency is the lead federal agency - if that other federal agency has completed project-specific ESA Section 7(a)(2) consultation for the NLEB, and has (1) determined that the project would not cause prohibited incidental take of the NLEB, and (2) completed coordination/consultation that is required by the USFWS (per the directions on the respective USFWS office's website), that project may proceed without notification to either the USACE or the USFWS, provided all General and Regional Permit Conditions are met.

The NLEB SLOPES can be viewed on the USACE website at the following World Wide Web Page: <http://www.saw.usace.army.mil/Missions/Regulatory-Permit-Program/Agency-Coordination/ESA/>. Permittees who do not have internet access may contact the USACE at (910) 251- 4633.

3.14 Work on Eastern Band of Cherokee Indians Land

All PCNs submitted for activities in waters of the United States on Eastern Band of Cherokee Indians (EBCI) trust land (i.e., Qualla Boundary and non-contiguous tracts of trust land), must comply with the requirements of the latest MOU between the Wilmington District and the Eastern Band of Cherokee Indians.

4.0 Additional Regional Conditions for Specific Nationwide Permits

4.1 NWP #23 - Approved Categorical Exclusions

4.1.1 The discharge of dredged or fill material associated with this NWP must not cause the loss of greater than 1 acre of waters of the United States or 500 linear feet of stream bed for each single and complete project.

4.1.2 No development activities authorized by this NWP may begin until the permittee obtains a consistency concurrence or a CAMA permit from the North Carolina Division of Coastal Management, if either is required.

ROY COOPER
Governor
MICHAEL S. REGAN
Secretary
LINDA CULPEPPER
Director



October 9, 2019

New Hanover County
NCDWR Project No. 20191300
Connection Between US 74 and SR 1409
STIP U-5710A

APPROVAL of 401 WATER QUALITY CERTIFICATION with ADDITIONAL CONDITIONS

Mr. Mason Herndon, Environmental Supervisor
NCDOT, Division 3
5501 Barbados Blvd.
Castle Hayne, NC 28429

Dear Mr. Herndon:

You have our approval, in accordance with the conditions listed below, for the following impacts for the purpose of constructing a northwest quadrant connection between US 74 (Eastwood Road) and SR 1409 (Military Cutoff Road) to improve the efficiency of the intersection in New Hanover County:

Stream Impacts in the White Oak River Basin

Site	Permanent Fill in Intermittent Stream (linear ft)	Temporary Fill in Intermittent Stream (linear ft)	Permanent Fill in Perennial Stream (linear ft)	Temporary Fill in Perennial Stream (linear ft)	Total Stream Impact (linear ft)	Stream Impacts Requiring Mitigation (linear ft)
Site 2 19+50 to 23+68.78-L	372				372	N/A
Site 2 (Channel Improvements)	91*	25			116	N/A
Site 2 (Channel Relocation)	62**	9			71	N/A
Total	525	34			559	N/A

Total Stream Impact for: 559 linear feet (406 lf)

*Channel improvements to correct vertical stream banks and removing sediment prohibiting positive flow (not to be considered a loss)

** Channel relocation to align the stream to an existing stream where a culvert is shown for a planned development (self-mitigating)



Wetland Impacts in the White Oak River Basin

Site	Fill (ac)	Fill (temporary) (ac)	Excavation (ac)	Mechanized Clearing (ac)	Hand Clearing (ac)	Area under Bridge (ac)	Total Wetland Impact (ac)
Site 1 15+80 to 16+30-L	0.038			0.007			0.045
Total	0.038			0.007			0.045

Total Wetland Impact: 0.045 acres.

The project shall be constructed in accordance with your application dated received September 30, 2019. After reviewing your application, we have decided that these impacts are covered by General Water Quality Certification Number 4140. This certification corresponds to the Nationwide Permit 23 issued by the Corps of Engineers. In addition, you should acquire any other federal, state or local permits before you proceed with your project including (but not limited to) Sediment and Erosion Control, Non-Discharge and Water Supply Watershed regulations. This approval will expire with the accompanying 404 permit.

This approval is valid solely for the purpose and design described in your application (unless modified below). Should your project change, you must notify the NCDWR and submit a new application. If the property is sold, the new owner must be given a copy of this Certification and approval letter and is thereby responsible for complying with all the conditions. If total wetland fills for this project (now or in the future) exceed one acre, or of total impacts to perennial streams (now or in the future) exceed 300 linear feet, compensatory mitigation may be required as described in 15A NCAC 2H .0506 (h) (6) and (7). For this approval to remain valid, you must adhere to the conditions listed in the attached certification and any additional conditions listed below.

Conditions of Certification:**Project Specific Conditions**

1. The NCDOT Division Environmental Officer or Environmental Assistant will conduct a pre-construction meeting with all appropriate staff to ensure that the project supervisor and essential staff understand the potential issues with stream and pipe alignment at the permitted site. NCDWR staff shall be invited to the pre-construction meeting. [15A NCAC 02H.0506(b)(2) and (b)(3)]
2. Erosion control matting in riparian areas shall not contain a nylon mesh grid which can impinge and entrap small animals. Matting should be secured in place by staples, stakes, or wherever possible live stakes of native trees. Riparian areas are defined as an area that is adjacent to a body of water. [15A NCAC 02B.0220]
3. Channel relocations shall be completed and stabilized, and approved on site by NCDWR staff, prior to diverting water into the new channel. Stream banks shall be matted with coir-fiber matting. Vegetation used for bank stabilization shall be limited to native riparian vegetation and should include establishment of a vegetated buffer on both sides of the relocated channel to the maximum extent practical. Also, rip-rap may be allowed if it is necessary to maintain the physical integrity of the stream, but the applicant must provide written justification and any calculations used to determine the extent of rip-rap coverage requested. Once the stream has been turned into the new channel, it may be necessary to relocate stranded fish to the new channel to prevent fish kills. [15A NCAC 02H .0506(b)(3)]

4. If multiple pipes or barrels are required, they shall be designed to mimic natural stream cross section as closely as possible including pipes or barrels at flood plain elevation and/or sills where appropriate. Widening the stream channel should be avoided. Stream channel widening at the inlet or outlet end of structures typically decreases water velocity causing sediment deposition that requires increased maintenance and disrupts aquatic life passage. [15A NCAC 02H.0506(b)(2)]
5. Riprap shall not be placed in the active thalweg channel or placed in the streambed in a manner that precludes aquatic life passage. Bioengineering boulders or structures should be properly designed, sized and installed. [15A NCAC 02H.0506(b)(2)]
6. For the 34 linear feet of streams being impacted due to site dewatering activities, the site shall be graded to its preconstruction contours and revegetated with appropriate native species. [15A NCAC 02H.0506(b)(2)]

General Conditions

7. Unless otherwise approved in this certification, placement of culverts and other structures in open waters and streams shall be placed below the elevation of the streambed by one foot for all culverts with a diameter greater than 48 inches, and 20 percent of the culvert diameter for culverts having a diameter less than 48 inches, to allow low flow passage of water and aquatic life. Design and placement of culverts and other structures including temporary erosion control measures shall not be conducted in a manner that may result in dis-equilibrium of wetlands or streambeds or banks, adjacent to or upstream and downstream of the above structures. The applicant is required to provide evidence that the equilibrium is being maintained if requested in writing by NCDWR. If this condition is unable to be met due to bedrock or other limiting features encountered during construction, please contact NCDWR for guidance on how to proceed and to determine whether or not a permit modification will be required. [15A NCAC 02H.0506(b)(2)]
8. If concrete is used during construction, a dry work area shall be maintained to prevent direct contact between curing concrete and stream water. Water that inadvertently contacts uncured concrete shall not be discharged to surface waters due to the potential for elevated pH and possible aquatic life and fish kills. [15A NCAC 02B.0200]
9. During the construction of the project, no staging of equipment of any kind is permitted in waters of the U.S. or protected riparian buffers. [15A NCAC 02H.0506(b)(2)]
10. The dimension, pattern and profile of the stream above and below the crossing shall not be modified. Disturbed floodplains and streams shall be restored to natural geomorphic conditions. [15A NCAC 02H.0506(b)(2)]
11. The use of rip-rap above the Normal High Water Mark shall be minimized. Any rip-rap placed for stream stabilization shall be placed in stream channels in such a manner that it does not impede aquatic life passage. [15A NCAC 02H.0506(b)(2)]
12. The Permittee shall ensure that the final design drawings adhere to the permit and to the permit drawings submitted for approval. [15A NCAC 02H .0507(c) and 15A NCAC 02H .0506 (b)(2) and (c)(2)]
13. All work in or adjacent to stream waters shall be conducted in a dry work area. Approved BMP measures from the most current version of NCDOT Construction and Maintenance Activities manual such as sandbags, rock berms, cofferdams and other diversion structures shall be used to prevent excavation in flowing water. [15A NCAC 02H.0506(b)(3) and (c)(3)]
14. Heavy equipment shall be operated from the banks rather than in the stream channel in order to minimize sedimentation and reduce the introduction of other pollutants into the stream. [15A NCAC 02H.0506(b)(3)]

15. All mechanized equipment operated near surface waters must be regularly inspected and maintained to prevent contamination of stream waters from fuels, lubricants, hydraulic fluids, or other toxic materials. [15A NCAC 02H.0506(b)(3)]
16. No rock, sand or other materials shall be dredged from the stream channel except where authorized by this certification. [15A NCAC 02H.0506(b)(3)]
17. Discharging hydroseed mixtures and washing out hydroseeders and other equipment in or adjacent to surface waters is prohibited. [15A NCAC 02H.0506(b)(3)]
18. The permittee and its authorized agents shall conduct its activities in a manner consistent with State water quality standards (including any requirements resulting from compliance with §303(d) of the Clean Water Act) and any other appropriate requirements of State and Federal law. If the NCDWR determines that such standards or laws are not being met (including the failure to sustain a designated or achieved use) or that State or federal law is being violated, or that further conditions are necessary to assure compliance, the NCDWR may reevaluate and modify this certification. [15A NCAC 02B.0200]
19. All fill slopes located in jurisdictional wetlands shall be placed at slopes no flatter than 3:1, unless otherwise authorized by this certification. [15A NCAC 02H.0506(b)(2)]
20. A copy of this Water Quality Certification shall be maintained on the construction site at all times. In addition, the Water Quality Certification and all subsequent modifications, if any, shall be maintained with the Division Engineer and the on-site project manager. [15A NCAC 02H .0507(c) and 15A NCAC 02H .0506 (b)(2) and (c)(2)]
21. The outside buffer, wetland or water boundary located within the construction corridor approved by this authorization shall be clearly marked by highly visible fencing prior to any land disturbing activities. Impacts to areas within the fencing are prohibited unless otherwise authorized by this certification. [15A NCAC 02H.0501 and .0502]
22. The issuance of this certification does not exempt the Permittee from complying with any and all statutes, rules, regulations, or ordinances that may be imposed by other government agencies (i.e. local, state, and federal) having jurisdiction, including but not limited to applicable buffer rules, stormwater management rules, soil erosion and sedimentation control requirements, etc.
23. The Permittee shall report any violations of this certification to the Division of Water Resources within 24 hours of discovery. [15A NCAC 02B.0506(b)(2)]
24. Upon completion of the project (including any impacts at associated borrow or waste sites), the NCDOT Division Engineer shall complete and return the enclosed "Certification of Completion Form" to notify the NCDWR when all work included in the 401 Certification has been completed. [15A NCAC 02H.0502(f)]
25. Native riparian vegetation must be reestablished in the riparian areas within the construction limits of the project by the end of the growing season following completion of construction. [15A NCAC 02B.0231(a)(6)]
26. There shall be no excavation from, or waste disposal into, jurisdictional wetlands or waters associated with this permit without appropriate modification. Should waste or borrow sites, or access roads to waste or borrow sites, be located in wetlands or streams, compensatory mitigation will be required since that is a direct impact from road construction activities.[15A NCAC 02H.0506(b)(3) and (c)(3)]

27. Erosion and sediment control practices must be in full compliance with all specifications governing the proper design, installation and operation and maintenance of such Best Management Practices in order to protect surface waters standards [15A NCAC 02H.0506(b)(3) and (c)(3)]:
- a. The erosion and sediment control measures for the project must be designed, installed, operated, and maintained in accordance with the most recent version of the *North Carolina Sediment and Erosion Control Planning and Design Manual*.
 - b. The design, installation, operation, and maintenance of the sediment and erosion control measures must be such that they equal, or exceed, the requirements specified in the most recent version of the *North Carolina Sediment and Erosion Control Manual*. The devices shall be maintained on all construction sites, borrow sites, and waste pile (spoil) projects, including contractor-owned or leased borrow pits associated with the project.
 - c. For borrow pit sites, the erosion and sediment control measures must be designed, installed, operated, and maintained in accordance with the most recent version of the *North Carolina Surface Mining Manual*.
 - d. The reclamation measures and implementation must comply with the reclamation in accordance with the requirements of the Sedimentation Pollution Control Act.
28. Sediment and erosion control measures shall not be placed in wetlands or waters unless otherwise approved by this Certification. [15A NCAC 02H.0506(b)(3) and (c)(3)]

If you wish to contest any statement in the attached Certification you must file a petition for an administrative hearing. You may obtain the petition form from the office of Administrative hearings. You must file the petition with the office of Administrative Hearings within sixty (60) days of receipt of this notice. A petition is considered filed when it is received in the office of Administrative Hearings during normal office hours. The Office of Administrative Hearings accepts filings Monday through Friday between the hours of 8:00am and 5:00pm, except for official state holidays. The original and one (1) copy of the petition must be filed with the Office of Administrative Hearings.

The petition may be faxed-provided the original and one copy of the document is received by the Office of Administrative Hearings within five (5) business days following the faxed transmission. The mailing address for the Office of Administrative Hearings is:

Office of Administrative Hearings
6714 Mail Service Center
Raleigh, NC 27699-6714
Telephone: (919) 431-3000, Facsimile: (919) 431-3100

A copy of the petition must also be served on DEQ as follows:

Mr. Bill F. Lane, General Counsel
Department of Environmental Quality
1601 Mail Service Center
Raleigh, NC 27699-1601

This letter completes the review of the Division of Water Resources under Section 401 of the Clean Water Act. If you have any questions, please contact Joanne Steenhuis at (910) 796-7306 or joanne.steenhuis@ncdenr.gov.

Sincerely,
DocuSigned by:



9C9886312DCD474...

Linda Culpepper, Director
Division of Water Resources

Electronic copy only distribution:

Brad Shaver, US Army Corps of Engineers, Wilmington Field Office

Cathy Brittingham, NC Division of Coastal Management

Beth Harmon, Division of Mitigation Services

Joanne Steenhuis, NC Division of Water Resources Wilmington Regional Office

File Copy

ROY COOPER
Governor
MICHAEL S. REGAN
Secretary
LINDA CULPEPPER
Director



NCDWR Project No.: _____ County: _____

Applicant: _____

Project Name: _____

Date of Issuance of 401 Water Quality Certification: _____

Certificate of Completion

Upon completion of all work approved within the 401 Water Quality Certification or applicable Buffer Rules, and any subsequent modifications, the applicant is required to return this certificate to the 401 Transportation Permitting Unit, North Carolina Division of Water Resources, 1617 Mail Service Center, Raleigh, NC, 27699-1617. This form may be returned to NCDWR by the applicant, the applicant’s authorized agent, **or** the project engineer. It is not necessary to send certificates from all of these.

Applicant’s Certification

I, _____, hereby state that, to the best of my abilities, due care and diligence was used in the observation of the construction such that the construction was observed to be built within substantial compliance and intent of the 401 Water Quality Certification and Buffer Rules, the approved plans and specifications, and other supporting materials.

Signature: _____ Date: _____

Agent’s Certification

I, _____, hereby state that, to the best of my abilities, due care and diligence was used in the observation of the construction such that the construction was observed to be built within substantial compliance and intent of the 401 Water Quality Certification and Buffer Rules, the approved plans and specifications, and other supporting materials.

Signature: _____ Date: _____

Engineer’s Certification

_____ Partial _____ Final

I, _____, as a duly registered Professional Engineer in the State of North Carolina, having been authorized to observe (periodically, weekly, full time) the construction of the project for the Permittee hereby state that, to the best of my abilities, due care and diligence was used in the observation of the construction such that the construction was observed to be built within substantial compliance and intent of the 401 Water Quality Certification and Buffer Rules, the approved plans and specifications, and other supporting materials.

Signature _____ Registration No. _____
Date _____



**STATE OF NORTH CAROLINA
DEPARTMENT OF ENVIRONMENTAL QUALITY
DIVISION OF WATER RESOURCES**

WATER QUALITY GENERAL CERTIFICATION NO. 4140

GENERAL CERTIFICATION FOR PROJECTS ELIGIBLE FOR US ARMY CORPS OF ENGINEERS

- **NATIONWIDE PERMIT NUMBER 23 (APPROVED CATEGORICAL EXCLUSIONS)**

Water Quality Certification Number 4140 is issued in conformity with the requirements of Section 401, Public Laws 92-500 and 95-217 of the United States and subject to the North Carolina Regulations in 15A NCAC 02H .0500 and 15A NCAC 02B .0200 for the discharge of fill material to surface waters and wetland areas as described in 33 CFR 330 Appendix A (B) (23) of the US Army Corps of Engineers regulations.

The State of North Carolina certifies that the specified category of activity will not violate applicable portions of Sections 301, 302, 303, 306 and 307 of the Public Laws 92-500 and 95-217 if conducted in accordance with the conditions hereinafter set forth.

Effective date: December 1, 2017

Signed this day: December 1, 2017

By

for Linda Culpepper
Interim Director

GC4140

Activities meeting any one (1) of the following thresholds or circumstances require written approval for a 401 Water Quality Certification from the Division of Water Resources (DWR):

- a) If any of the conditions of this Certification (listed below) cannot be met; or
- b) Total permanent impacts to streams equal or greater than 40 linear feet; or
- c) Any stream relocation or stream restoration; or
- d) Any impacts to streams from excavation or dredging other than excavation that is conducted as preparation for installing permanent fill or structures; or
- e) Total temporary or permanent impacts to wetlands and/or open waters equal to or greater than one-tenth (1/10) acre; or
- f) Any high-density project, as defined in 15A NCAC 02H .1003(2)(a) and by the density thresholds specified in 15A NCAC 02H .1017, which:
 - i. Disturbs one acre or more of land (including a project that disturbs less than one acre of land that is part of a larger common plan of development or sale); and
 - ii. Has permanent wetland, stream or open water impacts; and
 - iii. Is proposing new built-upon area; and
 - iv. Does not have a stormwater management plan reviewed and approved under a state stormwater program¹ or a state-approved local government stormwater program².

Projects that have vested rights, exemptions, or grandfathering from state or locally-implemented stormwater programs and projects that satisfy state or locally-implemented stormwater programs through use of community in-lieu programs **require written approval**; or

- g) Any permanent impacts to waters, or wetlands adjacent to waters, designated as: ORW (including SAV), HQW (including PNA), SA, WS-I, WS-II, Trout, or a North Carolina or National Wild and Scenic River; or
- h) Any permanent impacts to coastal wetlands [15A NCAC 7H .0205], or Unique Wetlands (UWL) [15A NCAC 2H .0506]; or
- i) Any impact associated with a Notice of Violation or an enforcement action for violation(s) of NC Wetland Rules (15A NCAC 02H .0500), NC Isolated Wetland Rules (15A NCAC 02H .1300), NC Surface Water or Wetland Standards (15A NCAC 02B .0200), or State Regulated Riparian Buffer Rules (15A NCAC 02B .0200); or
- j) Any impacts to subject water bodies and/or state regulated riparian buffers along subject water bodies in the Neuse, Tar-Pamlico, or Catawba River Basins or in the Randleman Lake, Jordan Lake or Goose Creek Watersheds (or any other basin or watershed with State Regulated Riparian Area Protection Rules [Buffer Rules] in effect at the time of application) *unless*:
 - i. The activities are listed as "EXEMPT" from these rules; or
 - ii. A Buffer Authorization Certificate is issued by the NC Division of Coastal Management (DCM); or

¹ e.g. Coastal Counties, HQW, ORW, or state-implemented Phase II NPDES

² e.g. Delegated Phase II NPDES, Water Supply Watershed, Nutrient-Sensitive Waters, or Universal Stormwater Management Program

GC4140

- iii. A Buffer Authorization Certificate or a Minor Variance is issued by a delegated or designated local government implementing a state riparian buffer program pursuant to 143-215.23.

Activities included in this General Certification that do not meet one of the thresholds listed above do not require written approval.

I. ACTIVITY SPECIFIC CONDITIONS:

1. For the North Carolina Department of Transportation, compliance with the NCDOT's individual NPDES permit NCS000250 shall serve to satisfy this condition. All other high-density projects that trigger threshold Item (f) above shall comply with the following requirements [15A NCAC 02H .0506 (b)(5) and (c)(5)]:
 - a. Provide a completed Stormwater Management Plan (SMP) for review and approval, including all appropriate stormwater control measure (SCM) supplemental forms and associated items, that complies with the high-density development requirements of 15A NCAC 02H .1003. Stormwater management shall be provided throughout the entire project area in accordance with 15A NCAC 02H .1003. For the purposes of 15A NCAC 02H .1003(2)(a), density thresholds shall be determined in accordance with 15A NCAC 02H .1017.
 - b. Provide documentation (including calculations, photos, etc.) that the project will not cause degradation of downstream surface waters. Documentation shall include a detailed analysis of the hydrological impacts from stormwater runoff when considering the volume and velocity of stormwater runoff from the project built upon area and the size and existing condition of the receiving stream(s).

Exceptions to this condition require application to and written approval from DWR.

II. GENERAL CONDITIONS:

1. When written authorization is required, the plans and specifications for the project are incorporated into the authorization by reference and are an enforceable part of the Certification. Any modifications to the project require notification to DWR and may require an application submittal to DWR with the appropriate fee. [15A NCAC 02H .0501 and .0502]
2. No waste, spoil, solids, or fill of any kind shall occur in wetlands or waters, beyond the footprint of the impacts (including temporary impacts) as authorized in the written approval from DWR; or beyond the thresholds established for use of this Certification without written authorization. [15A NCAC 02H .0501 and .0502]

No removal of vegetation or other impacts of any kind shall occur to state regulated riparian buffers beyond the footprint of impacts approved in a Buffer Authorization or Variance or as listed as an exempt activity in the applicable riparian buffer rules. [15A NCAC 02B .0200]

GC4140

3. In accordance with 15A NCAC 02H .0506(h) and Session Law 2017-10, compensatory mitigation may be required for losses of greater than 300 linear feet of perennial streams and/or greater than one (1) acre of wetlands. Impacts associated with the removal of a dam shall not require mitigation when the removal complies with the requirements of Part 3 of Article 21 in Chapter 143 of the North Carolina General Statutes. Impacts to isolated and other non-404 jurisdictional wetlands shall not be combined with 404 jurisdictional wetlands for the purpose of determining when impact thresholds trigger a mitigation requirement. For linear publicly owned and maintained transportation projects that are not determined to be part of a larger common plan of development by the US Army Corps of Engineers, compensatory mitigation may be required for losses of greater than 300 linear feet per perennial stream.

Compensatory stream and/or wetland mitigation shall be proposed and completed in compliance with G.S. 143-214.11. For applicants proposing to conduct mitigation within a project site, a complete mitigation proposal developed in accordance with the most recent guidance issued by the US Army Corps of Engineers Wilmington District shall be submitted for review and approval with the application for impacts.

4. All activities shall be in compliance with any applicable State Regulated Riparian Buffer Rules in Chapter 2 of Title 15A.
5. When applicable, all construction activities shall be performed and maintained in full compliance with G.S. Chapter 113A Article 4 (Sediment and Pollution Control Act of 1973). Regardless of applicability of the Sediment and Pollution Control Act, all projects shall incorporate appropriate Best Management Practices for the control of sediment and erosion so that no violations of state water quality standards, statutes, or rules occur. [15A NCAC 02H .0506(b)(3) and (c)(3) and 15A NCAC 02B .0200]

Design, installation, operation, and maintenance of all sediment and erosion control measures shall be equal to or exceed the requirements specified in the most recent version of the *North Carolina Sediment and Erosion Control Manual*, or for linear transportation projects, the *NCDOT Sediment and Erosion Control Manual*.

All devices shall be maintained on all construction sites, borrow sites, and waste pile (spoil) sites, including contractor-owned or leased borrow pits associated with the project. Sufficient materials required for stabilization and/or repair of erosion control measures and stormwater routing and treatment shall be on site at all times.

For borrow pit sites, the erosion and sediment control measures shall be designed, installed, operated, and maintained in accordance with the most recent version of the *North Carolina Surface Mining Manual*. Reclamation measures and implementation shall comply with the reclamation in accordance with the requirements of the Sedimentation Pollution Control Act and the Mining Act of 1971.

GC4140

If the project occurs in waters or watersheds classified as Primary Nursery Areas (PNAs), SA, WS-I, WS-II, High Quality Waters (HQW), or Outstanding Resource Waters (ORW), then the sedimentation and erosion control designs shall comply with the requirements set forth in 15A NCAC 04B .0124, *Design Standards in Sensitive Watersheds*.

6. Sediment and erosion control measures shall not be placed in wetlands or waters except within the footprint of temporary or permanent impacts authorized under this Certification. Exceptions to this condition require application to and written approval from DWR. [15A NCAC 02H .0501 and .0502]
7. Erosion control matting that incorporates plastic mesh and/or plastic twine shall not be used along streambanks or within wetlands. Exceptions to this condition require application to and written approval from DWR. [15A NCAC 02B .0201]
8. An NPDES Construction Stormwater Permit (NCG010000) is required for construction projects that disturb one (1) or more acres of land. The NCG010000 Permit allows stormwater to be discharged during land disturbing construction activities as stipulated in the conditions of the permit. If the project is covered by this permit, full compliance with permit conditions including the erosion & sedimentation control plan, inspections and maintenance, self-monitoring, record keeping and reporting requirements is required. [15A NCAC 02H .0506(b)(5) and (c)(5)]

The North Carolina Department of Transportation (NCDOT) shall be required to be in full compliance with the conditions related to construction activities within the most recent version of their individual NPDES (NCS000250) stormwater permit. [15A NCAC 02H .0506(b)(5) and (c)(5)]

9. All work in or adjacent to streams shall be conducted so that the flowing stream does not come in contact with the disturbed area. Approved best management practices from the most current version of the *NC Sediment and Erosion Control Manual*, or the *NC DOT Construction and Maintenance Activities Manual*, such as sandbags, rock berms, cofferdams, and other diversion structures shall be used to minimize excavation in flowing water. Exceptions to this condition require application to and written approval from DWR. [15A NCAC 02H .0506(b)(3) and (c)(3)]
10. If activities must occur during periods of high biological activity (e.g. sea turtle nesting, fish spawning, or bird nesting), then biological monitoring may be required at the request of other state or federal agencies and coordinated with these activities. [15A NCAC 02H .0506 (b)(2) and 15A NCAC 04B .0125]

All moratoriums on construction activities established by the NC Wildlife Resources Commission (WRC), US Fish and Wildlife Service (USFWS), NC Division of Marine Fisheries (DMF), or National Marine Fisheries Service (NMFS) shall be implemented. Exceptions to this condition require written approval by the resource agency responsible for the given moratorium. A copy of the approval from the resource agency shall be forwarded to DWR.

GC4140

Work within a designated trout watershed of North Carolina (as identified by the Wilmington District of the US Army Corps of Engineers), or identified state or federal endangered or threatened species habitat, shall be coordinated with the appropriate WRC, USFWS, NMFS, and/or DMF personnel.

11. Culverts shall be designed and installed in such a manner that the original stream profiles are not altered and allow for aquatic life movement during low flows. The dimension, pattern, and profile of the stream above and below a pipe or culvert shall not be modified by widening the stream channel or by reducing the depth of the stream in connection with the construction activity. The width, height, and gradient of a proposed culvert shall be such as to pass the average historical low flow and spring flow without adversely altering flow velocity. [15A NCAC 02H .0506(b)(2) and (c)(2)]

Placement of culverts and other structures in streams shall be below the elevation of the streambed by one foot for all culverts with a diameter greater than 48 inches, and 20% of the culvert diameter for culverts having a diameter less than or equal to 48 inches, to allow low flow passage of water and aquatic life.

If multiple pipes or barrels are required, they shall be designed to mimic the existing stream cross section as closely as possible including pipes or barrels at flood plain elevation and/or sills where appropriate. Widening the stream channel shall be avoided.

When topographic constraints indicate culvert slopes of greater than 5%, culvert burial is not required, provided that all alternative options for flattening the slope have been investigated and aquatic life movement/connectivity has been provided when possible (e.g. rock ladders, cross vanes, etc.). Notification, including supporting documentation to include a location map of the culvert, culvert profile drawings, and slope calculations, shall be provided to DWR 60 calendar days prior to the installation of the culvert.

When bedrock is present in culvert locations, culvert burial is not required provided that there is sufficient documentation of the presence of bedrock. Notification, including supporting documentation such as, a location map of the culvert, geotechnical reports, photographs, etc. shall be provided to DWR a minimum of 60 calendar days prior to the installation of the culvert. If bedrock is discovered during construction, then DWR shall be notified by phone or email within 24 hours of discovery.

If other site-specific topographic constraints preclude the ability to bury the culverts as described above and/or it can be demonstrated that burying the culvert would result in destabilization of the channel, then exceptions to this condition require application to and written approval from DWR.

GC4140

Installation of culverts in wetlands shall ensure continuity of water movement and be designed to adequately accommodate high water or flood conditions. When roadways, causeways, or other fill projects are constructed across FEMA-designated floodways or wetlands, openings such as culverts or bridges shall be provided to maintain the natural hydrology of the system as well as prevent constriction of the floodway that may result in destabilization of streams or wetlands.

The establishment of native woody vegetation and other soft stream bank stabilization techniques shall be used where practicable instead of rip-rap or other bank hardening methods.

12. Bridge deck drains shall not discharge directly into the stream. Stormwater shall be directed across the bridge and pre-treated through site-appropriate means to the maximum extent practicable (e.g. grassed swales, pre-formed scour holes, vegetated buffers, etc.) before entering the stream. Exceptions to this condition require application to and written approval from DWR. [15A NCAC 02H .0506(b)(5)]
13. Application of fertilizer to establish planted/seeded vegetation within disturbed riparian areas and/or wetlands shall be conducted at agronomic rates and shall comply with all other Federal, State and Local regulations. Fertilizer application shall be accomplished in a manner that minimizes the risk of contact between the fertilizer and surface waters. [15A NCAC 02B .0200 and 15A NCAC 02B .0231]
14. If concrete is used during construction, then all necessary measures shall be taken to prevent direct contact between uncured or curing concrete and waters of the state. Water that inadvertently contacts uncured concrete shall not be discharged to waters of the state. [15A NCAC 02B .0200]
15. All proposed and approved temporary fill and culverts shall be removed and the impacted area shall be returned to natural conditions within 60 calendar days after the temporary impact is no longer necessary. The impacted areas shall be restored to original grade, including each stream's original cross sectional dimensions, planform pattern, and longitudinal bed profile. For projects that receive written approval, no temporary impacts are allowed beyond those included in the application and authorization. All temporarily impacted sites shall be restored and stabilized with native vegetation. [15A NCAC 02H .0506(b)(2) and (c)(2)]
16. All proposed and approved temporary pipes/culverts/rip-rap pads etc. in streams shall be installed as outlined in the most recent edition of the *North Carolina Sediment and Erosion Control Planning and Design Manual* or the *North Carolina Surface Mining Manual* or the *North Carolina Department of Transportation Best Management Practices for Construction and Maintenance Activities* so as not to restrict stream flow or cause dis-equilibrium during use of this Certification. [15A NCAC 02H .0506(b)(2) and (c)(2)]

GC4140

17. Any rip-rap required for proper culvert placement, stream stabilization, or restoration of temporarily disturbed areas shall be restricted to the area directly impacted by the approved construction activity. All rip-rap shall be placed such that the original stream elevation and streambank contours are restored and maintained. Placement of rip-rap or other approved materials shall not result in de-stabilization of the stream bed or banks upstream or downstream of the area or in a manner that precludes aquatic life passage. [15A NCAC 02H .0506(b)(2)]
18. Any rip-rap used for stream or shoreline stabilization shall be of a size and density to prevent movement by wave, current action, or stream flows and shall consist of clean rock or masonry material free of debris or toxic pollutants. Rip-rap shall not be installed in the streambed except in specific areas required for velocity control and to ensure structural integrity of bank stabilization measures. [15A NCAC 02H .0506(b)(2)]
19. Applications for rip-rap groins proposed in accordance with 15A NCAC 07H .1401 (NC Division of Coastal Management General Permit for construction of Wooden and Rip-rap Groins in Estuarine and Public Trust Waters) shall meet all the specific conditions for design and construction specified in 15A NCAC 07H .1405.
20. All mechanized equipment operated near surface waters shall be inspected and maintained regularly to prevent contamination of surface waters from fuels, lubricants, hydraulic fluids, or other toxic materials. Construction shall be staged in order to minimize the exposure of equipment to surface waters to the maximum extent practicable. Fueling, lubrication and general equipment maintenance shall be performed in a manner to prevent, to the maximum extent practicable, contamination of surface waters by fuels and oils. [15A NCAC 02H .0506(b)(3) and (c)(3) and 15A NCAC 02B .0211 (12)]
21. Heavy equipment working in wetlands shall be placed on mats or other measures shall be taken to minimize soil disturbance. [15A NCAC 02H .0506(b)(3) and (c)(3)]
22. In accordance with 143-215.85(b), the applicant shall report any petroleum spill of 25 gallons or more; any spill regardless of amount that causes a sheen on surface waters; any petroleum spill regardless of amount occurring within 100 feet of surface waters; and any petroleum spill less than 25 gallons that cannot be cleaned up within 24 hours.
23. If an environmental document is required under the State Environmental Policy Act (SEPA), then this General Certification is not valid until a Finding of No Significant Impact (FONSI) or Record of Decision (ROD) is issued by the State Clearinghouse. If an environmental document is required under the National Environmental Policy Act (NEPA), then this General Certification is not valid until a Categorical Exclusion, the Final Environmental Assessment, or Final Environmental Impact Statement is published by the lead agency. [15A NCAC 01C .0107(a)]

GC4140

24. This General Certification does not relieve the applicant of the responsibility to obtain all other required Federal, State, or Local approvals before proceeding with the project, including those required by, but not limited to, Sediment and Erosion Control, Non-Discharge, Water Supply Watershed, and Trout Buffer regulations.
25. The applicant and their authorized agents shall conduct all activities in a manner consistent with State water quality standards (including any requirements resulting from compliance with §303(d) of the Clean Water Act), and any other appropriate requirements of State and Federal Law. If DWR determines that such standards or laws are not being met, including failure to sustain a designated or achieved use, or that State or Federal law is being violated, or that further conditions are necessary to assure compliance, then DWR may revoke or modify a written authorization associated with this General Water Quality Certification. [15A NCAC 02H .0507(d)]
26. The permittee shall require its contractors and/or agents to comply with the terms and conditions of this permit in the construction and maintenance of this project, and shall provide each of its contractors and/or agents associated with the construction or maintenance of this project with a copy of this Certification. A copy of this Certification, including all conditions shall be available at the project site during the construction and maintenance of this project. [15A NCAC 02H .0507 (c) and 15A NCAC 02H .0506 (b)(2) and (c)(2)]
27. When written authorization is required for use of this Certification, upon completion of all permitted impacts included within the approval and any subsequent modifications, the applicant shall be required to return a certificate of completion (available on the DWR website <https://edocs.deq.nc.gov/Forms/Certificate-of-Completion>). [15A NCAC 02H .0502(f)]
28. Additional site-specific conditions, including monitoring and/or modeling requirements, may be added to the written approval letter for projects proposed under this Water Quality Certification in order to ensure compliance with all applicable water quality and effluent standards. [15A NCAC 02H .0507(c)]
29. If the property or project is sold or transferred, the new permittee shall be given a copy of this Certification (and written authorization if applicable) and is responsible for complying with all conditions. [15A NCAC 02H .0501 and .0502]

III. GENERAL CERTIFICATION ADMINISTRATION:

1. In accordance with North Carolina General Statute 143-215.3D(e), written approval for a 401 Water Quality General Certification must include the appropriate fee. An applicant for a CAMA permit under Article 7 of Chapter 113A of the General Statutes for which a Water Quality Certification is required shall only make one payment to satisfy both agencies; the fee shall be as established by the Secretary in accordance with 143-215.3D(e)(7).

GC4140

2. This Certification neither grants nor affirms any property right, license, or privilege in any waters, or any right of use in any waters. This Certification does not authorize any person to interfere with the riparian rights, littoral rights, or water use rights of any other person and this Certification does not create any prescriptive right or any right of priority regarding any usage of water. This Certification shall not be interposed as a defense in any action respecting the determination of riparian or littoral rights or other rights to water use. No consumptive user is deemed by virtue of this Certification to possess any prescriptive or other right of priority with respect to any other consumptive user regardless of the quantity of the withdrawal or the date on which the withdrawal was initiated or expanded.
3. This Certification grants permission to the Director, an authorized representative of the Director, or DWR staff, upon the presentation of proper credentials, to enter the property during normal business hours. [15A NCAC 02H .0502(e)]
4. This General Certification shall expire on the same day as the expiration date of the corresponding Nationwide Permit and/or Regional General Permit. The conditions in effect on the date of issuance of Certification for a specific project shall remain in effect for the life of the project, regardless of the expiration date of this Certification. This General Certification is rescinded when the US Army Corps of Engineers reauthorizes any of the corresponding Nationwide Permits and/or Regional General Permits or when deemed appropriate by the Director of the Division of Water Resources.
5. Non-compliance with or violation of the conditions herein set forth by a specific project may result in revocation of this General Certification for the project and may also result in criminal and/or civil penalties.
6. The Director of the North Carolina Division of Water Resources may require submission of a formal application for Individual Certification for any project in this category of activity if it is deemed in the public's best interest or determined that the project is likely to have a significant adverse effect upon water quality, including state or federally listed endangered or threatened aquatic species, or degrade the waters so that existing uses of the water or downstream waters are precluded.

History Note: Water Quality Certification (WQC) Number 4140 issued December 1, 2017 replaces WQC4093 issued March 3, 2017; WQC 3891 issued March 19, 2012; WQC 3701 issued November 1, 2007; WQC Number 3632 issued March 2007; WQC Number 3403 issued March 2003; WQC Number 3361 issued March 18, 2002; WQC Number 3107 issued February 11, 1997; WQC Number 2734 issued May 1 1993; and WQC Number 2670 issued on January 21, 1992.



North Carolina Department of Transportation

Highway Stormwater Program
STORMWATER MANAGEMENT PLAN
 FOR NCDOT PROJECTS



(Version 2.08; Released April 2018)

WBS Element: 50115.1.2 TIP No.: U-5710A County(ies): New Hanover Page 1 of 2

General Project Information

WBS Element:	50115.1.2	TIP Number:	U-5710A	Project Type:	New Location	Date:	8/15/2019
NCDOT Contact:	Michael Bass		Contractor / Designer:	Joshua Massrock			
Address:	5501 Barbados Blvd. Castle Hayne, NC 28429		Address:	555 Fayetteville St. Suit 900 Raleigh, NC 27601			
	Phone:	910-341-2000		Phone:	919-232-6631		
	Email:	mlbass@ncdot.gov		Email:	joshua.massrock@hdrinc.com		
City/Town:	Wilmington		County(ies):	New Hanover			
River Basin(s):	White Oak		CAMA County?	Yes			
Wetlands within Project Limits?	Yes						

Project Description

Project Length (lin. miles or feet):	0.251 miles	Surrounding Land Use:	Commercial/Residential				
	Proposed Project		Existing Site				
Project Built-Upon Area (ac.)	4.7	ac.	N/A		ac.		
Typical Cross Section Description:	(4) 12'-0" travel lanes with curb and gutter and 33'-0" grass median.			N/A - New Alignment			

Annual Avg Daily Traffic (veh/hr/day):	Design/Future:	24,000	Year:	2040	Existing:	N/A	Year:	N/A
--	----------------	--------	-------	------	-----------	-----	-------	-----

General Project Narrative:
 (Description of Minimization of Water Quality Impacts)

Project Description: The proposed project (U-5710A) is a new alignment connector between US 74 (Eastwood Road) and SR 1409 (Military Cutoff Road) in New Hanover County, NC.

Impact Minimization Efforts: The team has designed a 2' Base Tail Ditch (Detail A) to receive roadway runoff from the project to minimize direct runoff into the adjacent jurisdictional stream. The tail ditch is approximately 42' long with 3:1 side slopes with a ditch slope of 0.6%.

Waterbody Information

Surface Water Body (1):	UT to Bradley Creek		NCDWR Stream Index No.:	18-87-24-4-(1)			
NCDWR Surface Water Classification for Water Body	Primary Classification:		Class SC				
	Supplemental Classification:		High Quality Waters (HQW)				
Other Stream Classification:	None						
Impairments:	mercury (Hg)						
Aquatic T&E Species?	No	Comments:					
NRTR Stream ID:	SA		Buffer Rules in Effect:		N/A		
Project Includes Bridge Spanning Water Body?	No	Deck Drains Discharge Over Buffer?	N/A	Dissipator Pads Provided in Buffer?		N/A	
Deck Drains Discharge Over Water Body?	N/A	(If yes, provide justification in the General Project Narrative)		(If yes, describe in the General Project Narrative; if no, justify in the General Project Narrative)			
(If yes, provide justification in the General Project Narrative)							

09_08/19

PLOT DRIVER: NCDOT_paf_color_eng_100.plt
 USER: jmassroc
 FILE: North_Carolina_Dept_of_Transportation\2014_16_Planning_Design\LSA\U-5710_TO_4_c\06.00_Project_Engineering_and_Design\U-5710A_Hydraulics\PERMITS_Environment\Drawings\U5710A_PRM_TSH.dgn
 PENTABLE: NCDOT_permits.nocount
 DATE: 7/29/2019 4:17:38 PM

CONTRACT:

TIP PROJECT: U-5710A

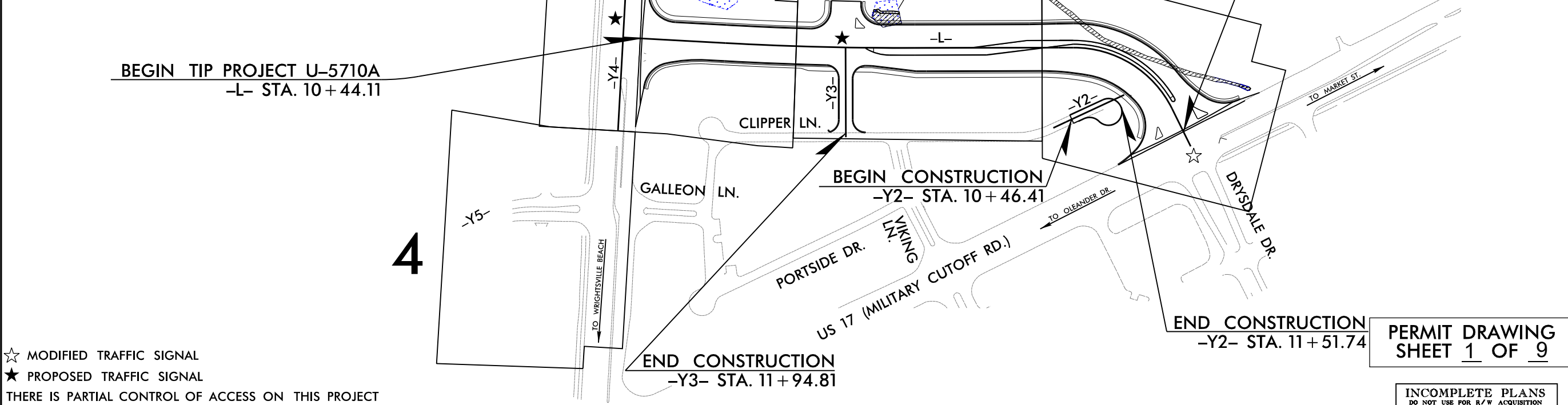
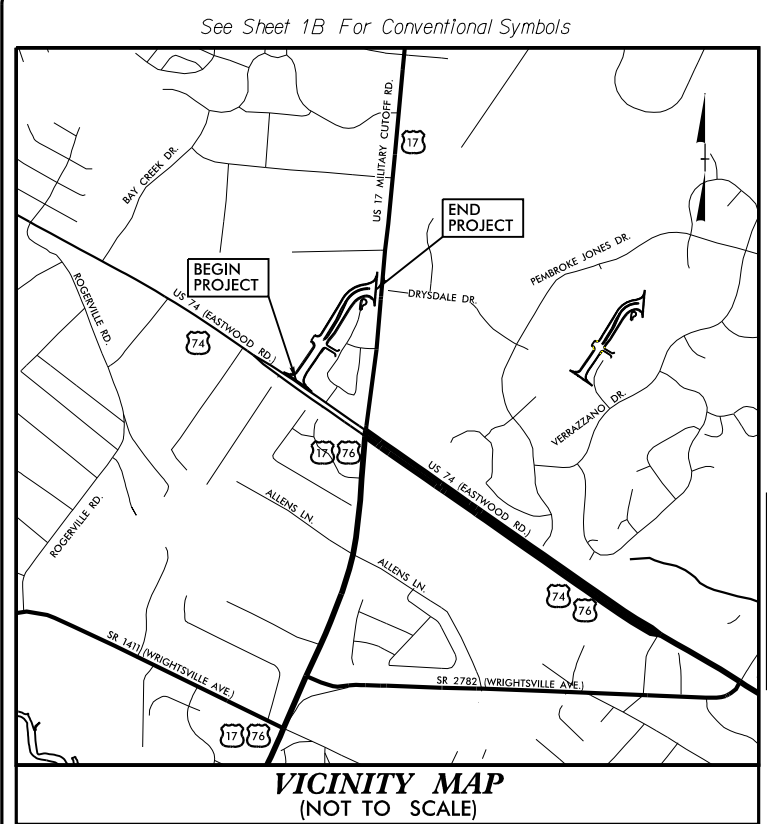

THERE IS PARTIAL CONTROL OF ACCESS ON THIS PROJECT
 THIS PROJECT IS WITHIN THE MUNICIPAL BOUNDARIES OF WILMINGTON
 CLEARING ON THIS PROJECT SHALL BE PERFORMED TO THE LIMITS ESTABLISHED BY MODIFIED METHOD III.

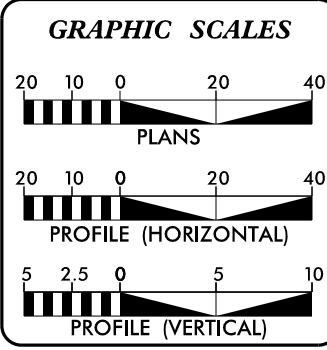

DESIGN DATA

ADT 2020 =	4,800
ADT 2040 =	24,000
V =	40 MPH
FUNC CLASS =	URBAN COLLECTOR
STATEWIDE TIER	

PROJECT LENGTH

LENGTH ROADWAY TIP PROJECT U-5710A =	0.251 MILES
TOTAL LENGTH TIP PROJECT U-5710A =	0.251 MILES

Prepared by the Office of:

HDR
2018 STANDARD SPECIFICATIONS

HDR Engineering, Inc. of the Carolinas
555 Fayetteville St, Suite 900 Raleigh, N.C. 27601
N.C.B.E.L.S. License Number: F-0116

RIGHT OF WAY DATE:
JANUARY 21, 2019

LETTING DATE:
APRIL 21, 2020

PHILLIP E. ROGERS, PE
PROJECT ENGINEER

CASEY E. HARRIS, PE
PROJECT DESIGN ENGINEER

MICHAEL BASS
NCDOT CONTACT

HYDRAULICS ENGINEER

SIGNATURE: _____ P.E.

ROADWAY DESIGN ENGINEER

SIGNATURE: _____ P.E.

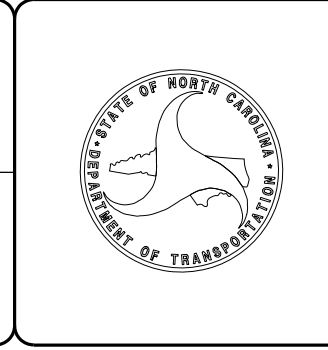

PERMIT DRAWING SHEET 1 OF 9

INCOMPLETE PLANS
DO NOT USE FOR R/W ACQUISITION
DOCUMENT NOT CONSIDERED FINAL UNLESS ALL SIGNATURES COMPLETED

STATE OF NORTH CAROLINA
DIVISION OF HIGHWAYS

NEW HANOVER COUNTY



LOCATION: NEW LOCATION NORTHWESTERN QUADRANT CONNECTION BETWEEN US 74 (EASTWOOD RD.) AND SR 1409 (MILITARY CUTOFF RD.)

TYPE OF WORK: GRADING, PAVING, DRAINAGE AND SIGNALS

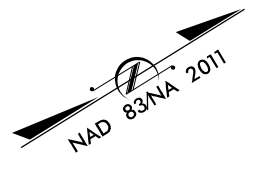
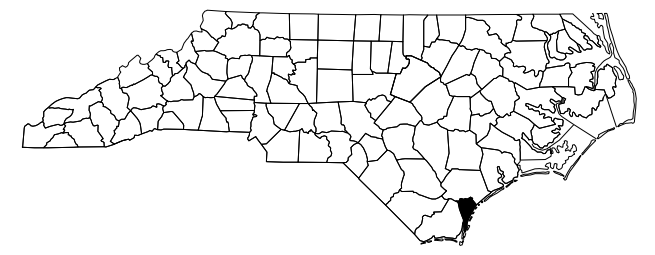
STATE	STATE PROJECT REFERENCE NO.	SHEET NO.	TOTAL SHEETS
N.C.	U-5710A	1	
STATE PROJ. NO.	F.A. PROJ. NO.	DESCRIPTION	
50115.1.2	N/A	P.E.	

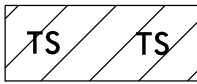

LEGEND:

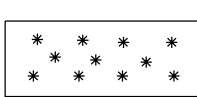
-  DENOTES IMPACTS IN SURFACE WATER
-  DENOTES TEMPORARY IMPACTS IN SURFACE WATER
-  DENOTES FILL IN WETLAND
-  DENOTES MECHANIZED CLEARING

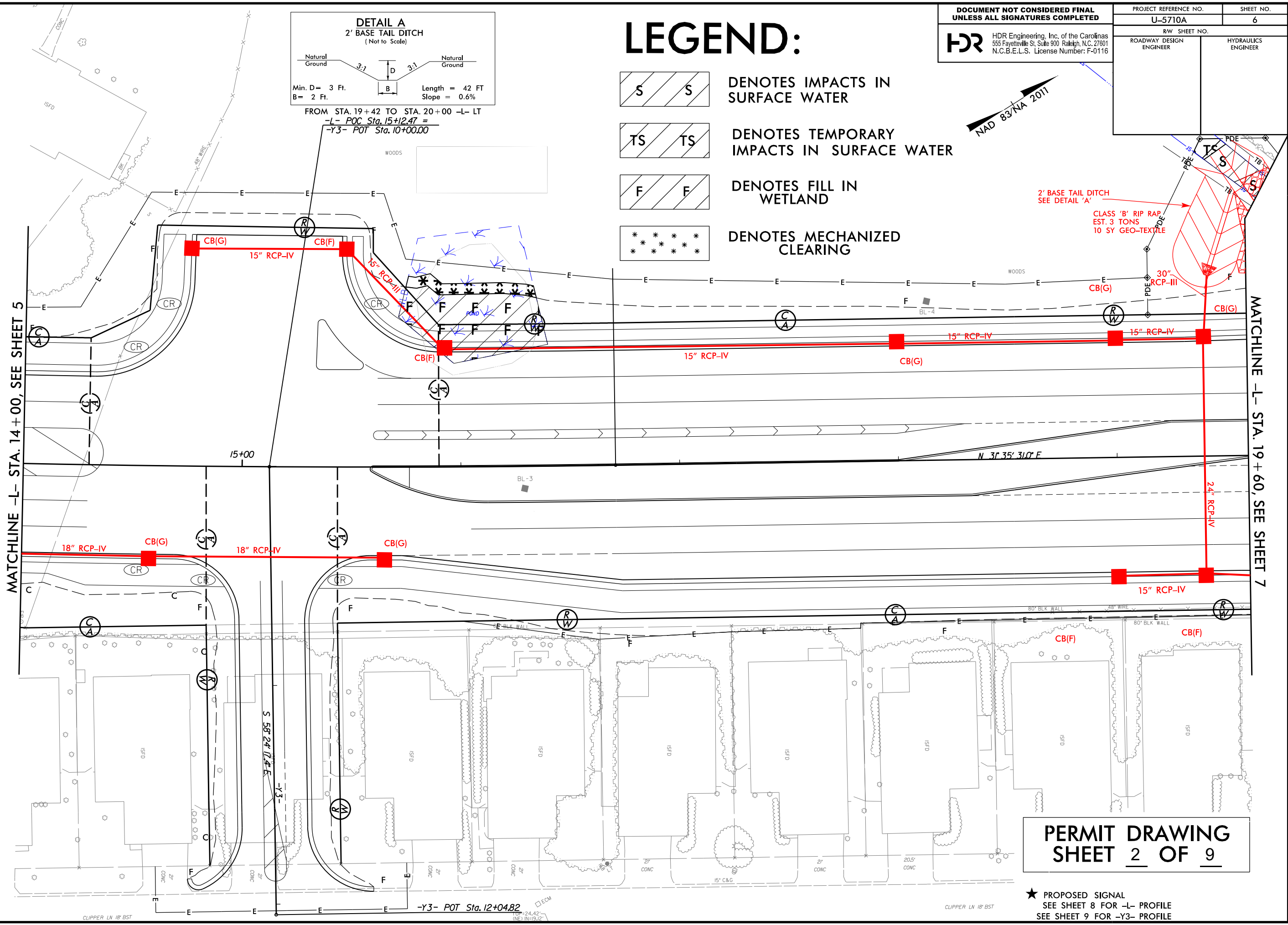
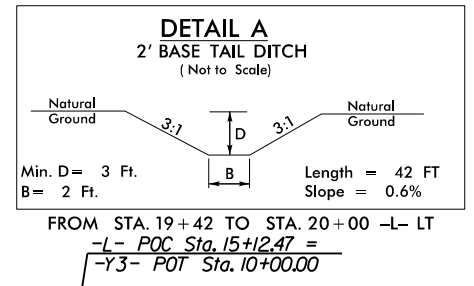
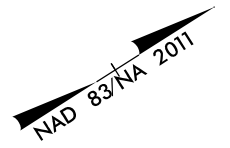

MATCHLINE -L- STA. 14+00, SEE SHEET 5

MATCHLINE -L- STA. 19+60, SEE SHEET 7

PERMIT DRAWING
SHEET 2 OF 9

★ PROPOSED SIGNAL
SEE SHEET 8 FOR -L- PROFILE
SEE SHEET 9 FOR -Y3- PROFILE

PLOT DRIVER: NCDOT_pdf_color_eng_100.plt
USER: JMASSROC
DATE: 8/19/2019
TIME: 5:42:27 PM
FILE: North_Carolina_Dept_of_Transportation\2014_16_Planning_Design_LSA\U-5710_TO_4_c\06_00_Project_Engineering_and_Design\U-5710A_Hydraulics\PERMITS_Environment\Drawings\U5710A_FRM_PSH.dgn

REVISIONS
ROW REV. - JUNE 19, 2019 - ADDED TCE TO PARCELS 1 & 2. ADDITIONAL PDE AND TWEAKED ROW ON PARCEL 2. REDUCED TCE ON PARCELS 6, 7, 8 AND 9. CEH
ROW REV. - AUGUST 16, 2019 - PARCEL 2 RE-NUMBERED TO PARCEL 1. ADDED RIGHT OF WAY AND TCE AROUND CENTERPOINT STUBOUT ON PARCEL 1. REMOVED TCE ON PARCELS 3 & 5
ELIMINATING CLAIMS. PARCEL 15A ADDED FOR EASTPORT HOA. CEH.





CLIPPER LN 18' BST

CLIPPER LN 18' BST

-Y3- POT Sta. 12+04.82

EQM
TOP = 24.42'
INF = 19.12'

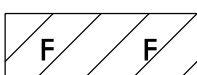
LEGEND:

-  DENOTES IMPACTS IN SURFACE WATER
-  DENOTES TEMPORARY IMPACTS IN SURFACE WATER
-  DENOTES FILL IN WETLAND
-  DENOTES MECHANIZED CLEARING

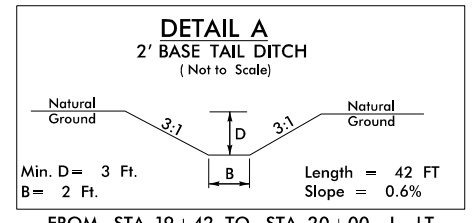

FROM STA. 19+42 TO STA. 20+00 -L- LT
 -L- POC Sta. 15+12.47 =
 -Y3- POT Sta. 10+00.00

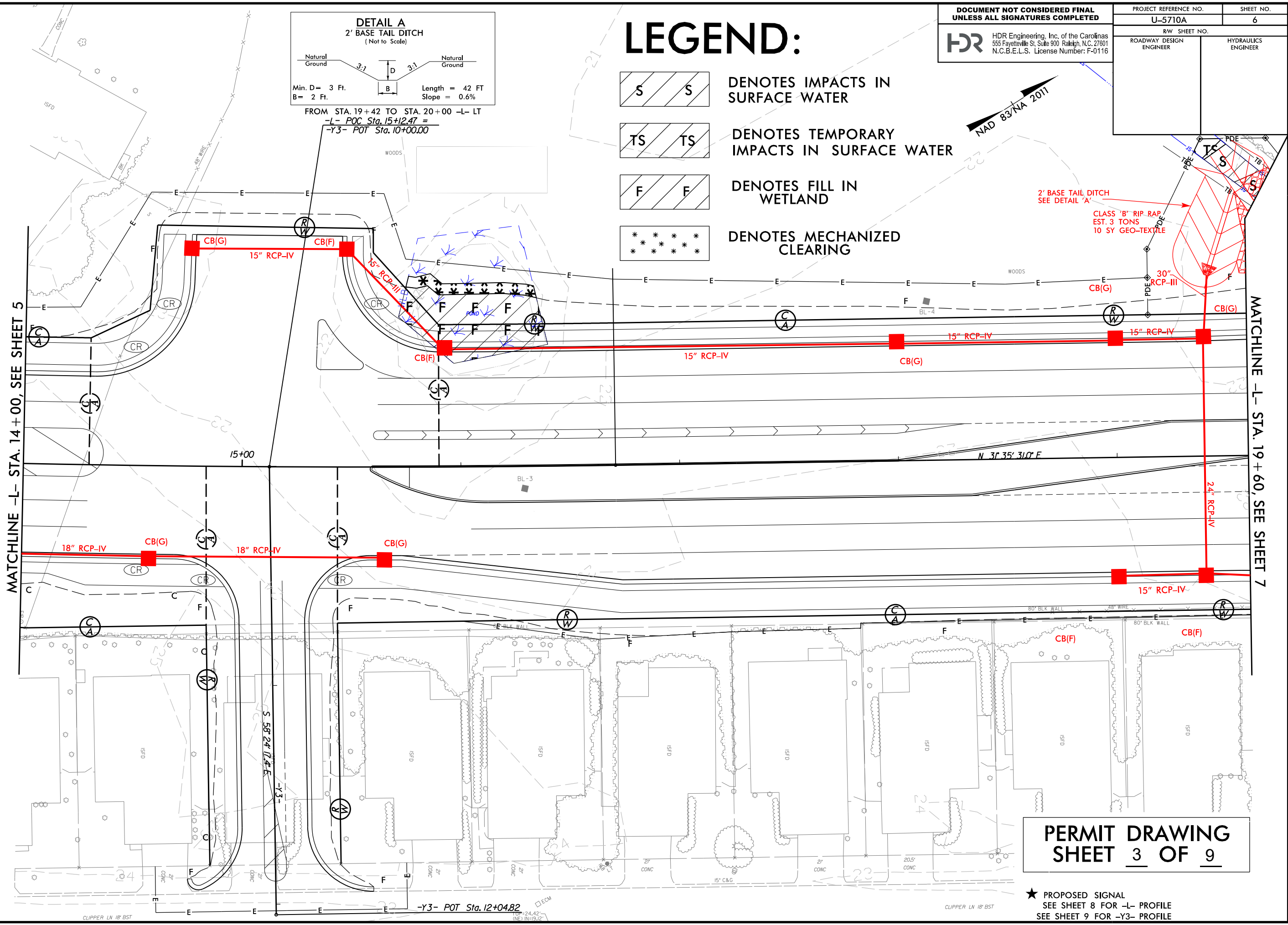

MATCHLINE -L- STA. 14+00, SEE SHEET 5

MATCHLINE -L- STA. 19+60, SEE SHEET 7



2' BASE TAIL DITCH
SEE DETAIL 'A'
 CLASS 'B' RIP RAP
EST. 3 TONS
10 SY GEO-TEXTILE

PERMIT DRAWING
SHEET 3 OF 9

★ PROPOSED SIGNAL
 SEE SHEET 8 FOR -L- PROFILE
 SEE SHEET 9 FOR -Y3- PROFILE

PLOT DRIVER: NCDOT_pdf_color_eng_100.plt
 USER: JMASSROC
 FILE: North_Carolina_Dept_of_Transportation\2014_16_Planning_Design_LSA\U-5710_TO_4_c\06_00_Project_Engineering_and_Design\U-5710A_Hydraulics\PERMITS_Environment\Drawings\U5710A_PRM_PSH.dgn
 PENTABLE: NCDOT_permits.CON.tbl
 TIME: 5:41:43 PM
 DATE: 8/19/2019
 ROW REV. - JUNE 19, 2019 - ADDED TCE TO PARCELS 1 & 2. ADDITIONAL PDE AND TWEAKED ROW ON PARCEL 2. REDUCED TCE ON PARCELS 6, 7, 8 AND 9. CEH
 ROW REV. - AUGUST 16, 2019 - PARCEL 2 RE-NUMBERED TO PARCEL 1. ADDED RIGHT OF WAY AND TCE AROUND CENTERPOINT STUBOUT ON PARCEL 1. REMOVED TCE ON PARCELS 3 & 5 ELIMINATING CLAIMS. PARCEL 15A ADDED FOR EASTPORT HOA. CEH.

CLIPPER LN 18' BST

CLIPPER LN 18' BST

-Y3- POT Sta. 12+04.82

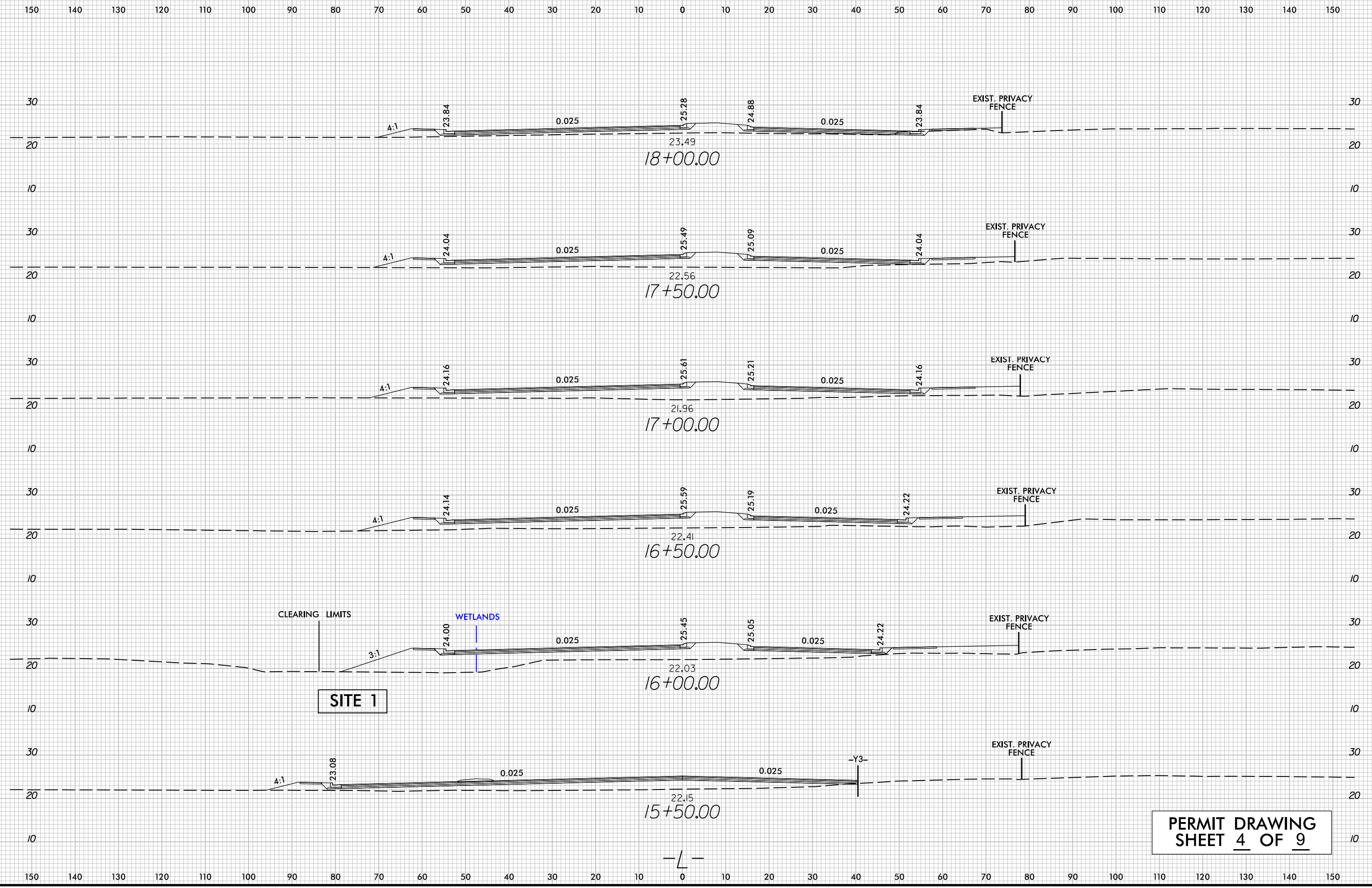

8/23/99



PLOT DRIVER: NCDOT_color_eng_100.plt
 USER: _USERNAME_ DATE: 7/29/2019 TIME: 5:38:52 PM
 FILE: U5710A_PRM.XPL.L

PERMIT DRAWING
SHEET 4 OF 9

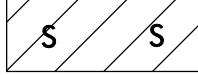
LEGEND:

-  DENOTES IMPACTS IN SURFACE WATER
-  DENOTES TEMPORARY IMPACTS IN SURFACE WATER

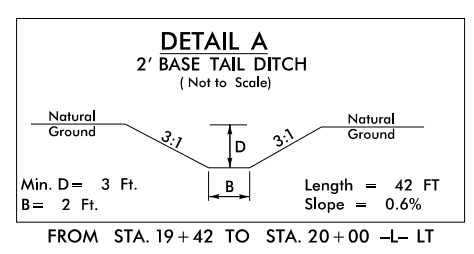
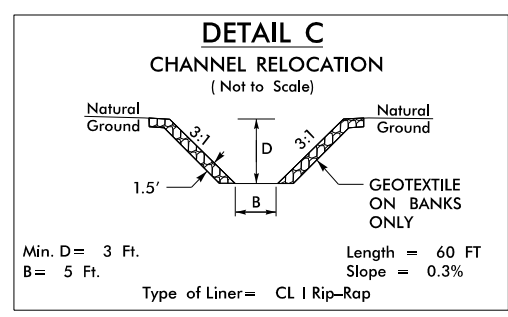

STA. 19+80 -L- LT
EST. 80 TONS
EST. 110 SY GEO-TEXTILE

SITE 2

REVISIONS
 ROW REV. - JUNE 19, 2019 - ADDED TCE TO PARCELS 1 & 2. ADDITIONAL PDE AND TWEAKED ROW ON PARCEL 2. REDUCED TCE ON PARCELS 6, 7, 8 AND 9. CEH.
 ROW REV. - AUGUST 16, 2019 - PARCEL 2 RE-NUMBERED TO PARCEL 1. ADDED RIGHT OF WAY AND TCE AROUND CENTERPOINT STUBOUT ON PARCEL 1. REMOVED TCE ON PARCELS 3 & 5 ELIMINATING CLAIMS. PARCEL 15A ADDED FOR EASTPORT HOA. CEH.

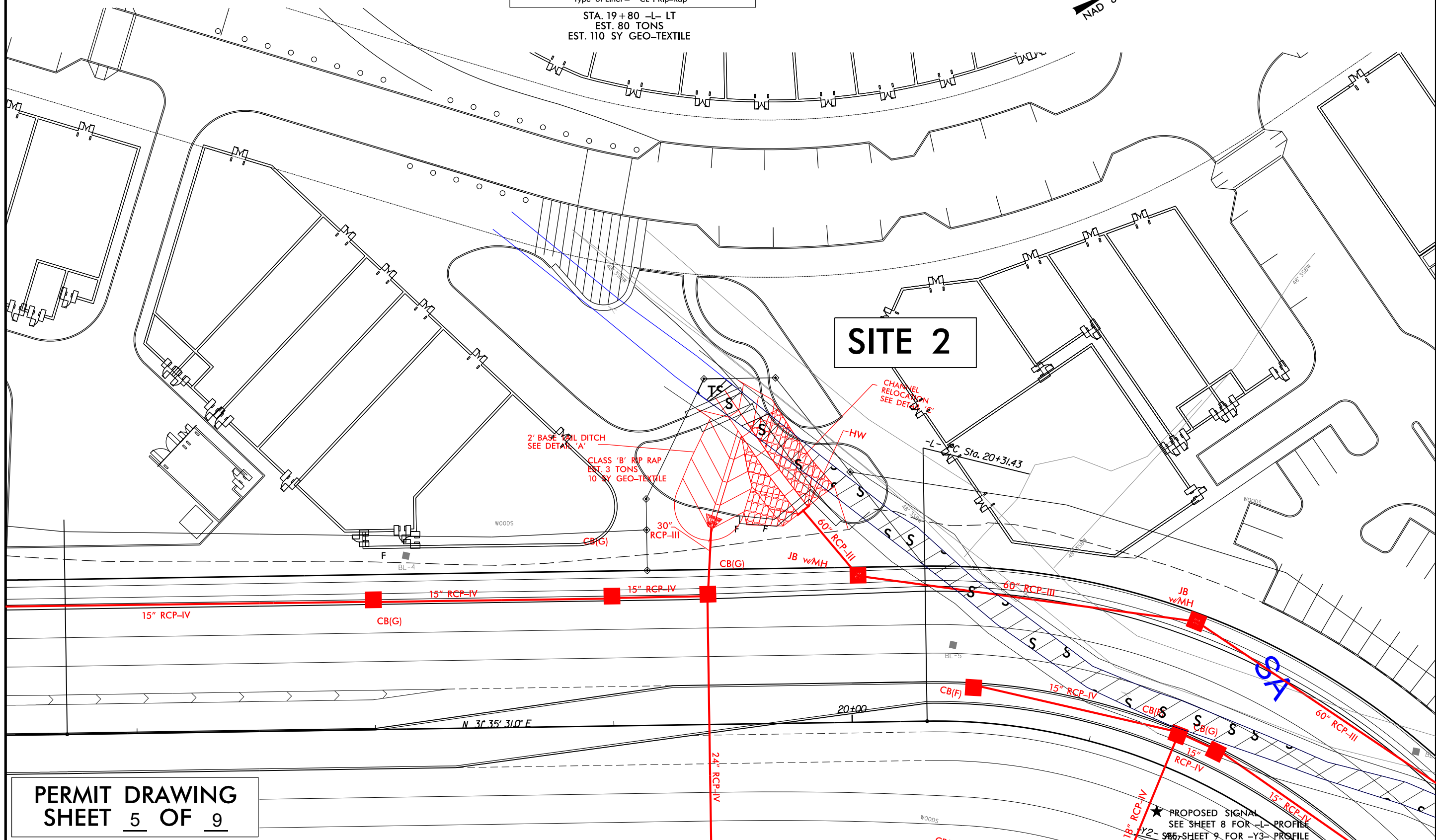

PERMIT DRAWING
SHEET 5 OF 9

★ PROPOSED SIGNAL
SEE SHEET 8 FOR -L- PROFILE
SEE SHEET 9 FOR -Y3- PROFILE

DOCUMENT NOT CONSIDERED FINAL UNLESS ALL SIGNATURES COMPLETED		PROJECT REFERENCE NO. U-5710A	SHEET NO. 6A
HDR HDR Engineering, Inc. of the Carolinas 555 Fayetteville St, Suite 900 Raleigh, N.C. 27601 N.C.B.E.L.S. License Number: F-0116		RW SHEET NO. ROADWAY DESIGN ENGINEER	HYDRAULICS ENGINEER

LEGEND:

- DENOTES IMPACTS IN SURFACE WATER
- DENOTES TEMPORARY IMPACTS IN SURFACE WATER

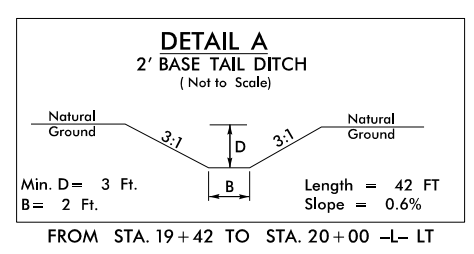
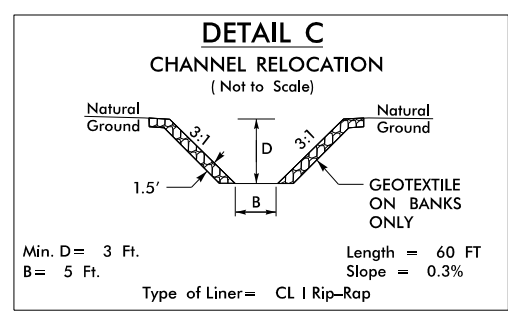

STA. 19+80 -L- LT
EST. 80 TONS
EST. 110 SY GEO-TEXTILE

SITE 2

REVISIONS
 ROW REV. - JUNE 19, 2019 - ADDED TCE TO PARCELS 1 & 2. ADDITIONAL PDE AND TWEAKED ROW ON PARCEL 2. REDUCED TCE ON PARCELS 6, 7, 8 AND 9. CEH.
 ROW REV. - AUGUST 16, 2019 - PARCEL 2 RE-NUMBERED TO PARCEL 1. ADDED RIGHT OF WAY AND TCE AROUND CENTERPOINT STUBOUT ON PARCEL 1. REMOVED TCE ON PARCELS 3 & 5 ELIMINATING CLAIMS. PARCEL 15A ADDED FOR EASTPORT HOA. CEH.

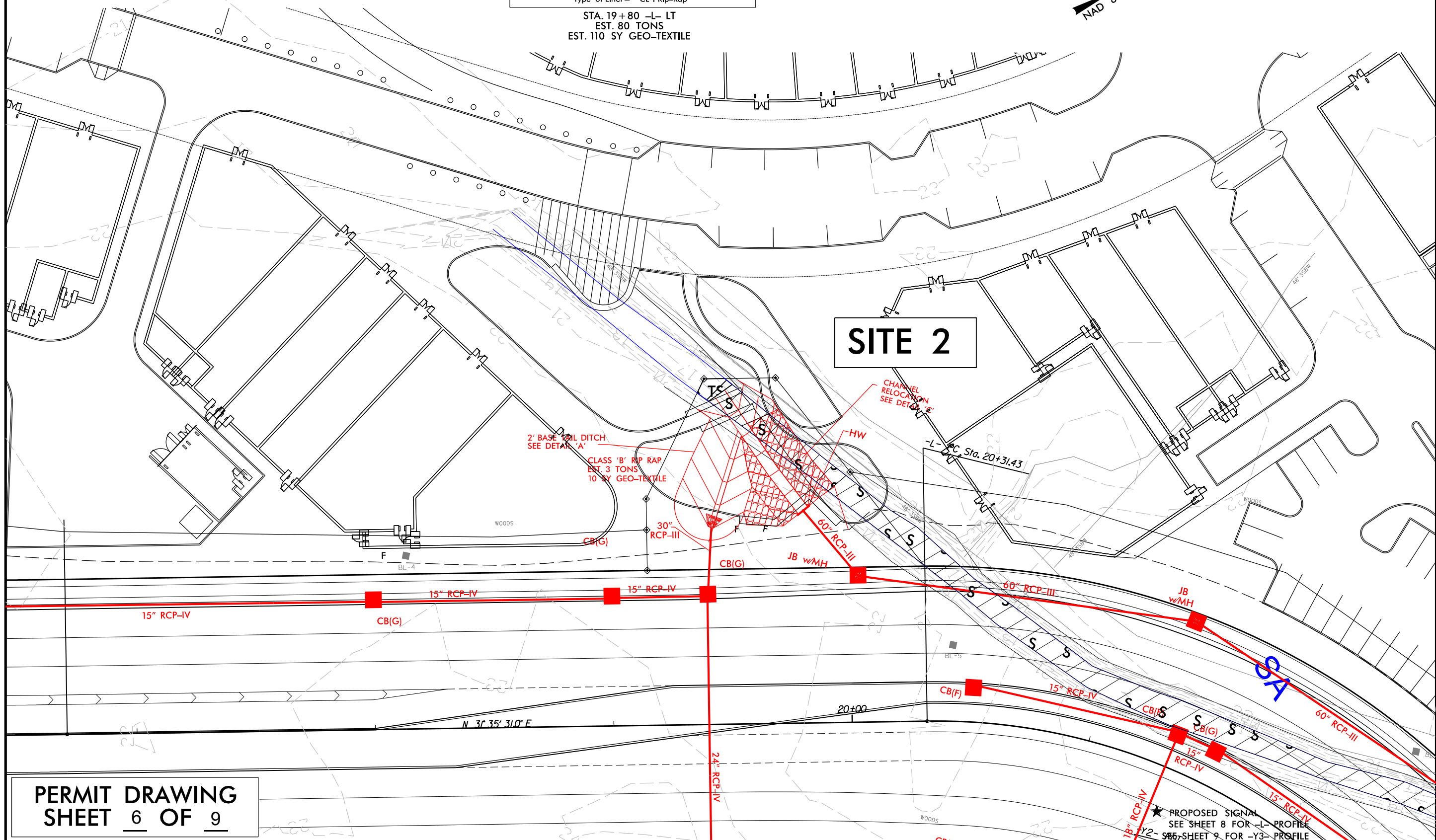

**PERMIT DRAWING
SHEET 6 OF 9**

★ PROPOSED SIGNAL
SEE SHEET 8 FOR -L- PROFILE
SEE SHEET 9 FOR -Y3- PROFILE

LEGEND:

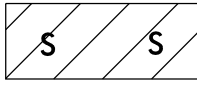

DENOTES IMPACTS IN SURFACE WATER

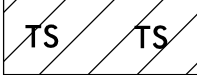

DENOTES TEMPORARY IMPACTS IN SURFACE WATER

13 THOMAS HERGA
DB 5654 PG 0358
MB 32 PG 295

14 ETHEL L. REYNOLDS
DB 4902 PG 0969
MB 32 PG 295

SITE 2



PROJECT REFERENCE NO. U-5710A	SHEET NO. 7
RW SHEET NO.	
ROADWAY DESIGN ENGINEER	HYDRAULICS ENGINEER
DOCUMENT NOT CONSIDERED FINAL UNLESS ALL SIGNATURES COMPLETED	
HDR Engineering, Inc. of the Carolinas 555 Fayetteville St. Suite 900 Raleigh, N.C. 27601 N.C.B.E.L.S. License Number: F-0116	

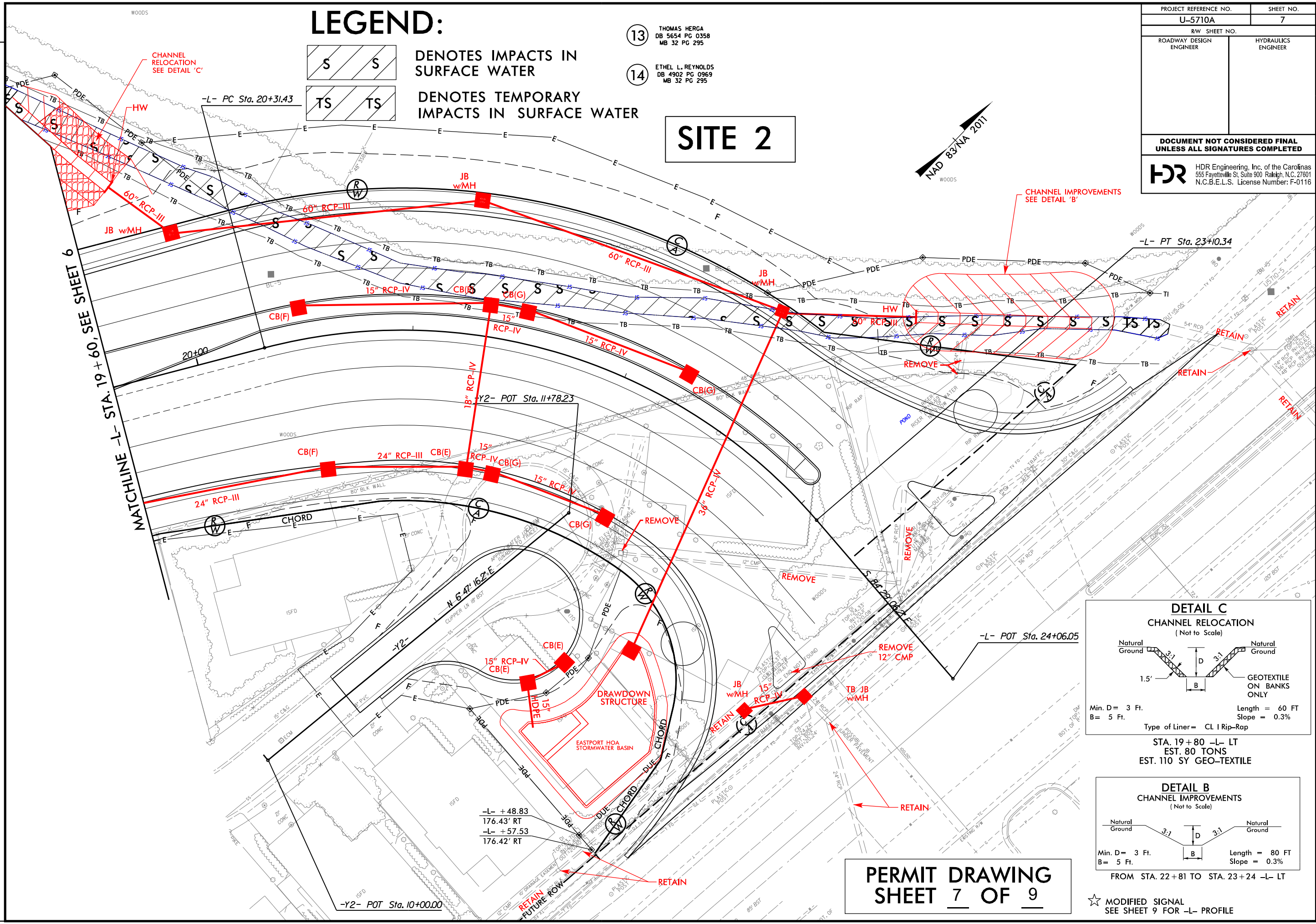

MATCHLINE -L- STA. 19+60, SEE SHEET 6

ROW REV. - JUNE 19, 2019 - REVISED PDE AND ADDED TCE TO PARCEL 2, REVISED TCE TO STAY OFF OF HOUSE ON PARCEL 10. CEH
ROW REV. - AUGUST 16, 2019 - PARCEL 2 RE-NUMBERED TO PARCEL 11. ROW ADJUSTED AND REDUCED ON PARCELS 12 & 13.
PUE ON PARCEL 12 CHANGED TO DUE AND MODIFIED. PDE ADDED TO PARCELS 12 & 13. CEH.

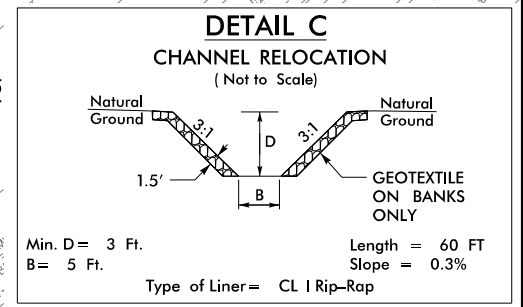

STA. 19+80 -L- LT
EST. 80 TONS
EST. 110 SY GEO-TEXTILE

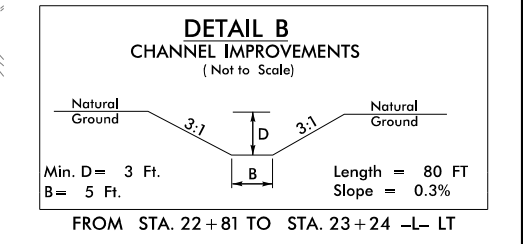

PERMIT DRAWING SHEET 7 OF 9

★ MODIFIED SIGNAL
SEE SHEET 9 FOR -L- PROFILE

PLOT DRIVER: NCDOT_color_eng_100.plt
USER: JMASSROC
DATE: 8/21/2019
TIME: 8:33:15 AM
FILE: North_Carolina_Dept_of_Transportation\2014_16_Planning_Design\LSA\U5710_TO_4_c\0600.Project.Engineering_and.Design\U5710A\Hydraulics\PERMITS.Environmental\Drawings\U5710A_PDM_PSH.dgn

REVISIONS

ROW REV. - JUNE 19, 2019 - REVISED PDE AND ADDED TCE TO PARCEL 2, REVISED TCE TO STAY OFF OF HOUSE ON PARCEL 10. CEH
ROW REV. - AUGUST 16, 2019 - PARCEL 2 RE-NUMBERED TO PARCEL 11. ROW ADJUSTED AND REDUCED ON PARCELS 12 & 13.
PUE ON PARCEL 12 CHANGED TO DUE AND MODIFIED. PDE ADDED TO PARCELS 12 & 13. CEH.

PROJECT REFERENCE NO.	SHEET NO.
U-5710A	7
RW SHEET NO.	
ROADWAY DESIGN ENGINEER	HYDRAULICS ENGINEER
DOCUMENT NOT CONSIDERED FINAL UNLESS ALL SIGNATURES COMPLETED	
 HDR Engineering, Inc. of the Carolinas 555 Fayetteville St. Suite 900 Raleigh, N.C. 27601 N.C.B.E.L.S. License Number: F-0116	

LEGEND:

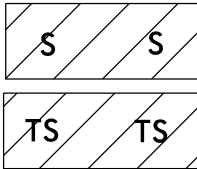

S DENOTES IMPACTS IN SURFACE WATER

TS DENOTES TEMPORARY IMPACTS IN SURFACE WATER

13 THOMAS HERGA
DB 5654 PG 0358
MB 32 PG 295

14 ETHEL L. REYNOLDS
DB 4902 PG 0969
MB 32 PG 295

SITE 2

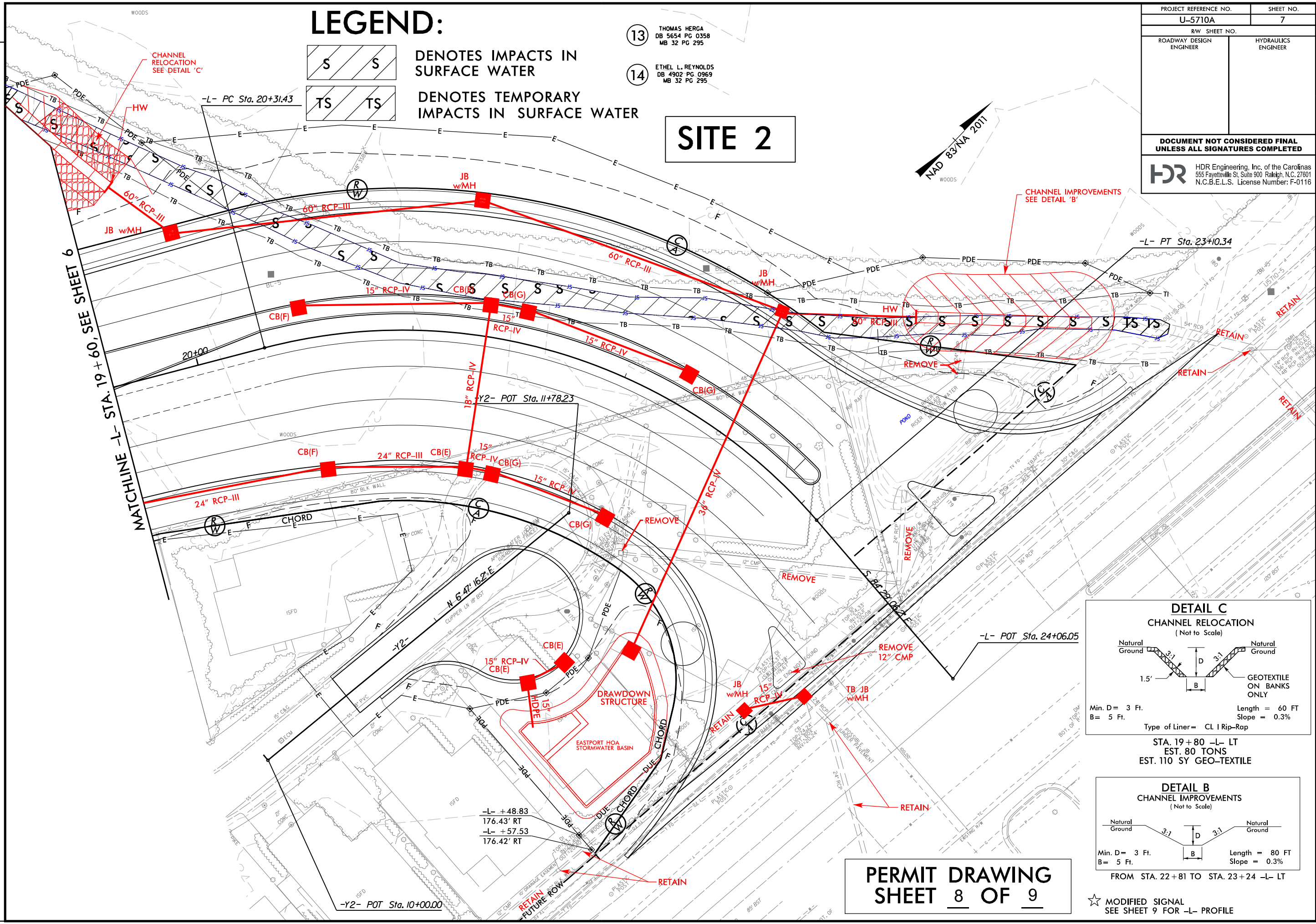
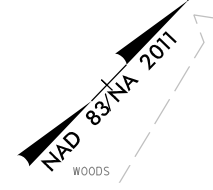

MATCHLINE -L- STA. 19+60, SEE SHEET 6

ROW REV. - JUNE 19, 2019 - REVISED PDE AND ADDED TCE TO PARCEL 2, REVISED TCE TO STAY OFF OF HOUSE ON PARCEL 10, CEH
ROW REV. - AUGUST 16, 2019 - PARCEL 2 RE-NUMBERED TO PARCEL 11, ROW ADJUSTED AND REDUCED ON PARCELS 12 & 13.
PUE ON PARCEL 12 CHANGED TO DUE AND MODIFIED. PDE ADDED TO PARCELS 12 & 13. CEH.

PLOT DRIVER: NCDOT_color_eng_100.plt
USER: JMASSROC
DATE: 8/21/2019
TIME: 8:32:41 AM
FILE: North_Carolina_Dept_of_Transportation\2014_16_Planning_Design\LSA\U5710_TO_4_c\06_00_Project_Engineering_and_Design\U-5710A_Hydraulics\PERMITS_Environment\Drawings\U5710A_PRM_PSH.dgn

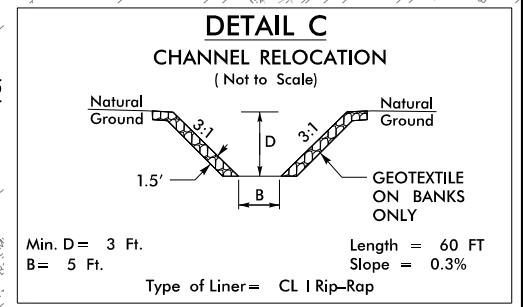

STA. 19+80 -L- LT
EST. 80 TONS
EST. 110 SY GEO-TEXTILE

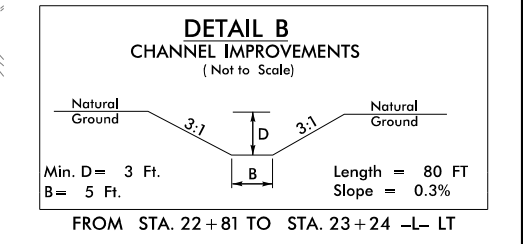

PERMIT DRAWING SHEET 8 OF 9

★ MODIFIED SIGNAL
SEE SHEET 9 FOR -L- PROFILE

WETLAND PERMIT IMPACT SUMMARY

Site No.	Station (From/To)	Structure Size / Type	WETLAND IMPACTS					SURFACE WATER IMPACTS				
			Permanent Fill In Wetlands (ac)	Temp. Fill In Wetlands (ac)	Excavation in Wetlands (ac)	Mechanized Clearing in Wetlands (ac)	Hand Clearing in Wetlands (ac)	Permanent SW impacts (ac)	Temp. SW impacts (ac)	Existing Channel Impacts Permanent (ft)	Existing Channel Impacts Temp. (ft)	Natural Stream Design (ft)
1	15+80 to 16+30 -L-	Roadway Fill	0.038			0.007						
2	19+50 to 23+68.78 -L-	60" RCP						0.094		372		
		Channel Improvements						0.015	0.004	91	25	
		Channel Relocation						0.010	0.002	62	9	
TOTALS*:			0.038	0.000	0.000	0.007	0.000	0.119	0.006	525	34	0

*Rounded totals are sum of actual impacts

NOTES:

NC DEPARTMENT OF TRANSPORTATION
 DIVISION OF HIGHWAYS
 08/19/2019
 NEW HANOVER
 U-5710A
 50115.1.2
 SHEET 9 OF 9

**Project Special Provisions
Erosion Control**

STABILIZATION REQUIREMENTS:

(4-30-2019)

Stabilization for this project shall comply with the time frame guidelines as specified by the NCG-010000 general construction permit effective April 1, 2019 issued by the North Carolina Department of Environmental Quality Division of Water Resources. Temporary or permanent ground cover stabilization shall occur within 7 calendar days from the last land-disturbing activity, with the following exceptions in which temporary or permanent ground cover shall be provided in 14 calendar days from the last land-disturbing activity:

- Slopes between 2:1 and 3:1, with a slope length of 10 ft. or less
- Slopes 3:1 or flatter, with a slope of length of 50 ft. or less
- Slopes 4:1 or flatter

The stabilization timeframe for High Quality Water (HQW) Zones shall be 7 calendar days with no exceptions for slope grades or lengths. High Quality Water Zones (HQW) Zones are defined by North Carolina Administrative Code 15A NCAC 04A.0105 (25). Temporary and permanent ground cover stabilization shall be achieved in accordance with the provisions in this contract and as directed.

SEEDING AND MULCHING:

(East)

The kinds of seed and fertilizer, and the rates of application of seed, fertilizer, and limestone, shall be as stated below. During periods of overlapping dates, the kind of seed to be used shall be determined. All rates are in pounds per acre.

All Roadway Areas

March 1 - August 31		September 1 - February 28	
50#	Tall Fescue	50#	Tall Fescue
10#	Centipede	10#	Centipede
25#	Bermudagrass (hulled)	35#	Bermudagrass (unhulled)
500#	Fertilizer	500#	Fertilizer
4000#	Limestone	4000#	Limestone

Waste and Borrow Locations

March 1 – August 31		September 1 - February 28	
75#	Tall Fescue	75#	Tall Fescue
25#	Bermudagrass (hulled)	35#	Bermudagrass (unhulled)
500#	Fertilizer	500#	Fertilizer
4000#	Limestone	4000#	Limestone

Note: 50# of Bahiagrass may be substituted for either Centipede or Bermudagrass only upon Engineer's request.

Approved Tall Fescue Cultivars

06 Dust	Escalade	Justice	Serengeti
2 nd Millennium	Essential	Kalahari	Shelby
3 rd Millennium	Evergreen 2	Kitty Hawk 2000	Sheridan
Apache III	Falcon IV	Legitimate	Signia
Avenger	Falcon NG	Lexington	Silver Hawk
Barlexas	Falcon V	LSD	Sliverstar
Barlexas II	Faith	Magellan	Shenandoah Elite
Bar Fa	Fat Cat	Matador	Sidewinder
Barrera	Festnova	Millennium SRP	Skyline
Barrington	Fidelity	Monet	Solara
Barrobusto	Finelawn Elite	Mustang 4	Southern Choice II
Barvado	Finelawn Xpress	Ninja 2	Speedway
Biltmore	Finesse II	Ol' Glory	Spyder LS
Bingo	Firebird	Olympic Gold	Sunset Gold
Bizem	Firecracker LS	Padre	Taccoa
Blackwatch	Firenza	Patagonia	Tanzania
Blade Runner II	Five Point	Pedigree	Trio
Bonsai	Focus	Picasso	Tahoe II
Braveheart	Forte	Piedmont	Talladega
Bravo	Garrison	Plantation	Tarheel
Bullseye	Gazelle II	Proseeds 5301	Terrano
Cannavaro	Gold Medallion	Prospect	Titan ltd
Catalyst	Grande 3	Pure Gold	Titanium LS
Cayenne	Greenbrooks	Quest	Tracer
Cessane Rz	Greenkeeper	Raptor II	Traverse SRP
Chipper	Gremlin	Rebel Exeda	Tulsa Time
Cochise IV	Greystone	Rebel Sentry	Turbo
Constitution	Guardian 21	Rebel IV	Turbo RZ
Corgi	Guardian 41	Regiment II	Tuxedo RZ
Corona	Hemi	Regenerate	Ultimate
Coyote	Honky Tonk	Rendition	Venture
Darlington	Hot Rod	Rhambler 2 SRP	Umbrella
Davinci	Hunter	Rembrandt	Van Gogh
Desire	Inferno	Reunion	Watchdog
Dominion	Innovator	Riverside	Wolfpack II
Dynamic	Integrity	RNP	Xtremegreen
Dynasty	Jaguar 3	Rocket	
Endeavor	Jamboree	Scorpion	

On cut and fill slopes 2:1 or steeper Centipede shall be applied at the rate of 5 pounds per acre and add 20# of Sericea Lespedeza from January 1 - December 31.

Fertilizer shall be 10-20-20 analysis. A different analysis of fertilizer may be used provided the 1-2-2 ratio is maintained and the rate of application adjusted to provide the same amount of plant food as a 10-20-20 analysis and as directed.

Native Grass Seeding and Mulching (East)

Native Grass Seeding and Mulching shall be performed on the disturbed areas of wetlands and riparian areas, and adjacent to Stream Relocation construction within a 50 foot zone on both sides of the stream or depression, measured from top of stream bank or center of depression. The stream bank of the stream relocation shall be seeded by a method that does not alter the typical cross section of the stream bank. Native Grass Seeding and Mulching shall also be performed in the permanent soil reinforcement mat section of preformed scour holes, and in other areas as directed.

The kinds of seed and fertilizer, and the rates of application of seed, fertilizer, and limestone, shall be as stated below. During periods of overlapping dates, the kind of seed to be used shall be determined. All rates are in pounds per acre.

March 1 - August 31		September 1 - February 28	
18#	Creeping Red Fescue	18#	Creeping Red Fescue
6#	Indiangrass	6#	Indiangrass
8#	Little Bluestem	8#	Little Bluestem
4#	Switchgrass	4#	Switchgrass
25#	Browntop Millet	35#	Rye Grain
500#	Fertilizer	500#	Fertilizer
4000#	Limestone	4000#	Limestone

Approved Creeping Red Fescue Cultivars:

- Aberdeen
- Boreal
- Epic
- Cindy Lou

Fertilizer shall be 10-20-20 analysis. A different analysis of fertilizer may be used provided the 1-2-2 ratio is maintained and the rate of application adjusted to provide the same amount of plant food as a 10-20-20 analysis and as directed.

Native Grass Seeding and Mulching shall be performed in accordance with Section 1660 of the *Standard Specifications* and vegetative cover sufficient to restrain erosion shall be installed immediately following grade establishment.

Measurement and Payment

Native Grass *Seeding and Mulching* will be measured and paid for in accordance with Article 1660-8 of the *Standard Specifications*.

All areas seeded and mulched shall be tacked with asphalt. Crimping of straw in lieu of asphalt tack shall not be allowed on this project.

CRIMPING STRAW MULCH:

Crimping shall be required on this project adjacent to any section of roadway where traffic is to be maintained or allowed during construction. In areas within six feet of the edge of pavement, straw is to be applied and then crimped. After the crimping operation is complete, an additional application of straw shall be applied and immediately tacked with a sufficient amount of undiluted emulsified asphalt.

Straw mulch shall be of sufficient length and quality to withstand the crimping operation.

Crimping equipment including power source shall be subject to the approval of the Engineer providing that maximum spacing of crimper blades shall not exceed 8".

TEMPORARY SEEDING:

Fertilizer shall be the same analysis as specified for *Seeding and Mulching* and applied at the rate of 400 pounds and seeded at the rate of 50 pounds per acre. Sweet Sudan Grass, German Millet or Browntop Millet shall be used in summer months and Rye Grain during the remainder of the year. The Engineer will determine the exact dates for using each kind of seed.

FERTILIZER TOPDRESSING:

Fertilizer used for topdressing on all roadway areas except slopes 2:1 and steeper shall be 10-20-20 grade and shall be applied at the rate of 500 pounds per acre. A different analysis of fertilizer may be used provided the 1-2-2 ratio is maintained and the rate of application adjusted to provide the same amount of plant food as 10-20-20 analysis and as directed.

Fertilizer used for topdressing on slopes 2:1 and steeper and waste and borrow areas shall be 16-8-8 grade and shall be applied at the rate of 500 pounds per acre. A different analysis of fertilizer may be used provided the 2-1-1 ratio is maintained and the rate of application adjusted to provide the same amount of plant food as 16-8-8 analysis and as directed.

SUPPLEMENTAL SEEDING:

The kinds of seed and proportions shall be the same as specified for *Seeding and Mulching*, with the exception that no centipede seed will be used in the seed mix for supplemental seeding. The rate of application for supplemental seeding may vary from 25# to 75# per acre. The actual rate per acre will be determined prior to the time of topdressing and the Contractor will be notified in writing of the rate per acre, total quantity needed, and areas on which to apply the supplemental seed. Minimum tillage equipment, consisting of a sod seeder shall be used for incorporating seed into the soil as to prevent disturbance of existing vegetation. A clodbuster (ball and chain) may be used where degree of slope prevents the use of a sod seeder.

MOWING:

The minimum mowing height on this project shall be 4 inches.

LAWN TYPE APPEARANCE:

All areas adjacent to lawns must be hand finished as directed to give a lawn type appearance. Remove all trash, debris, and stones $\frac{3}{4}$ " and larger in diameter or other obstructions that could interfere with providing a smooth lawn type appearance. These areas shall be reseeded to match their original vegetative conditions, unless directed otherwise by the Field Operations Engineer.

RESPONSE FOR EROSION CONTROL:**Description**

Furnish the labor, materials, tools and equipment necessary to move personnel, equipment, and supplies to the project necessary for the pursuit of any or all of the following work as shown herein, by an approved subcontractor.

Section	Erosion Control Item	Unit
1605	Temporary Silt Fence	LF
1606	Special Sediment Control Fence	LF/TON
1615	Temporary Mulching	ACR
1620	Seed - Temporary Seeding	LB
1620	Fertilizer - Temporary Seeding	TN
1631	Matting for Erosion Control	SY
SP	Coir Fiber Mat	SY
1640	Coir Fiber Baffles	LF
SP	Permanent Soil Reinforcement Mat	SY
1660	Seeding and Mulching	ACR
1661	Seed - Repair Seeding	LB
1661	Fertilizer - Repair Seeding	TON
1662	Seed - Supplemental Seeding	LB
1665	Fertilizer Topdressing	TON
SP	Safety/Highly Visible Fencing	LF
SP	Response for Erosion Control	EA

Construction Methods

Provide an approved subcontractor who performs an erosion control action as described in the NPDES Inspection Form SPPP30. Each erosion control action may include one or more of the above work items.

Measurement and Payment

Response for Erosion Control will be measured and paid for by counting the actual number of times the subcontractor moves onto the project, including borrow and waste sites, and satisfactorily completes an erosion control action described in Form 1675. The provisions of Article 104-5 of the *Standard Specifications* will not apply to this item of work.

Payment will be made under:

Pay Item	Pay Unit
Response for Erosion Control	Each

HIGH QUALITY WATERS:

Description

UT to Bradley Creek has been identified as high quality waters. This designation requires special procedures to be used for clearing and grubbing, temporary stream crossings, and grading operations within the High Quality Water Zone and as designated by the Engineer. The High Quality Water Zones are identified on the plans as Environmentally Sensitive Areas. This also requires special procedures to be used for seeding and mulching and staged seeding.

The High Quality Water Zone/Environmentally Sensitive Area shall be defined as a 50-foot buffer zone on both sides of the stream measured from top of streambank.

Construction Methods

(A) Clearing and Grubbing

In areas identified as High Quality Water Zones/Environmentally Sensitive Areas, the Contractor may perform clearing operations, but not grubbing operations until immediately prior to beginning grading operations as described in Article 200-1 of the *Standard Specifications*. Only clearing operations (not grubbing) shall be allowed in this buffer zone until immediately prior to beginning grading operations. Erosion control devices shall be installed immediately following the clearing operation.

(B) Grading

Once grading operations begin in identified High Quality Water Zones/ Environmentally Sensitive Areas, work shall progress in a continuous manner until complete. All construction within these areas shall progress in a continuous manner such that each phase is complete and areas are permanently stabilized prior to beginning of next phase. Failure

on the part of the Contractor to complete any phase of construction in a continuous manner in High Quality Water Zones/ Environmentally Sensitive Areas will be just cause for the Engineer to direct the suspension of work in accordance with Article 108-7 of the *Standard Specifications*.

(C) Temporary Stream Crossings

Any crossing of streams within the limits of this project shall be accomplished in accordance with the requirements of Subarticle 107-12 of the *Standard Specifications*.

(D) Seeding and Mulching

Seeding and mulching shall be performed in accordance with Section 1660 of the *Standard Specifications* and vegetative cover sufficient to restrain erosion shall be installed immediately following grade establishment.

Seeding and mulching shall be performed on the areas disturbed by construction immediately following final grade establishment. No appreciable time shall lapse into the contract time without stabilization of slopes, ditches and other areas within the High Quality Water Zones/Environmentally Sensitive Areas.

(E) Stage Seeding

The work covered by this section shall consist of the establishment of a vegetative cover on cut and fill slopes as grading progresses. Seeding and mulching shall be done in stages on cut and fill slopes that are greater than 20 feet in height measured along the slope, or greater than 2 acres in area. Each stage shall not exceed the limits stated above.

Additional payments will not be made for the requirements of this section, as the cost for this work shall be included in the contract unit prices for the work involved.

MINIMIZE REMOVAL OF VEGETATION:

The Contractor shall minimize removal of vegetation within project limits to the maximum extent practicable. Vegetation along stream banks and adjacent to other jurisdictional resources outside the construction limits shall only be removed upon approval of Engineer. No additional payment will be made for this minimization work.

STOCKPILE AREAS:

The Contractor shall install and maintain erosion control devices sufficient to contain sediment around any erodible material stockpile areas as directed.

ACCESS AND HAUL ROADS:

At the end of each working day, the Contractor shall install or re-establish temporary diversions or earth berms across access/haul roads to direct runoff into sediment devices. Silt fence sections that are temporarily removed shall be reinstalled across access/haul roads at the end of each working day.

CONSTRUCTION MATERIALS MANAGEMENT

(3-19-19) (rev. 04-27-19)

Description

The requirements set forth shall be adhered to in order to meet the applicable materials handling requirements of the NCG010000 permit. Structural controls installed to manage construction materials stored or used on site shall be shown on the E&SC Plan. Requirements for handling materials on construction sites shall be as follows:

Polyacrylamides (PAMS) and Flocculants

Polyacrylamides (PAMS) and flocculants shall be stored in leak-proof containers that are kept under storm-resistant cover or surrounded by secondary containment structures designed to protect adjacent surface waters. PAMS or other flocculants used shall be selected from the NC DWR List of Approved PAMS/Flocculants. The concentration of PAMS and other flocculants used shall not exceed those specified in the NC DWR List of Approved PAMS/Flocculants and in accordance with the manufacturer's instructions. The NC DWR List of Approved PAMS/Flocculants is available at:

https://files.nc.gov/ncdeq/Water%20Quality/Environmental%20Sciences/ATU/ApprovedPAMS_4_1_2017.pdf

Equipment Fluids

Fuels, lubricants, coolants, and hydraulic fluids, and other petroleum products shall be handled and disposed of in a manner so as not to enter surface or ground waters and in accordance with applicable state and federal regulations. Equipment used on the site must be operated and maintained properly to prevent discharge of fluids. Equipment, vehicle, and other wash waters shall not be discharged into E&SC basins or other E&SC devices. Alternative controls should be provided such that there is no discharge of soaps, solvents, or detergents.

Waste Materials

Construction materials and land clearing waste shall be disposed of in accordance with North Carolina General Statutes, Chapter 130A, Article 9 - Solid Waste Management, and rules governing the disposal of solid waste (15A NCAC 13B). Areas dedicated for managing construction material and land clearing waste shall be at least 50 feet away from storm drain inlets and surface waters unless it can be shown that no other alternatives are reasonably available. Paint

and other liquid construction material waste shall not be dumped into storm drains. Paint and other liquid construction waste washouts should be located at least 50 feet away from storm drain inlets unless there is no alternative. Other options are to install lined washouts or use portable, removable bags or bins. Hazardous or toxic waste shall be managed in accordance with the federal Resource Conservation and Recovery Act (RCRA) and NC Hazardous Waste Rules at 15A NCAC, Subchapter 13A. Litter and sanitary waste shall be managed in a manner to prevent it from entering jurisdictional waters and shall be disposed of offsite.

Herbicide, Pesticide, and Rodenticides

Herbicide, pesticide, and rodenticides shall be stored and applied in accordance with the Federal Insecticide, Fungicide, and Rodenticide Act, North Carolina Pesticide Law of 1971 and labeling restrictions.

Concrete Materials

Concrete materials onsite, including excess concrete, must be controlled and managed to avoid contact with surface waters, wetlands or buffers. No concrete or cement slurry shall be discharged from the site. (Note that discharges from onsite concrete plants require coverage under a separate NPDES permit – NCG140000.) Concrete wash water shall be managed in accordance with the *Concrete Washout Structure* provision. Concrete slurry shall be managed and disposed of in accordance with *NCDOT DGS and HOS DCAR Distribution of Class A Residuals Statewide* (Permit No. WQ0035749). Any hardened concrete residue will be disposed of, or recycled on site, in accordance with state solid waste regulations.

Earthen Material Stock Piles

Earthen material stock piles shall be located at least 50 feet away from storm drain inlets and surface waters unless it can be shown that no other alternatives are reasonably available.

Measurement and Payment

Conditions set within the *Construction Materials Management* provision are incidental to the project for which no direct compensation will be made.

WASTE AND BORROW SOURCES:

Payment for temporary erosion control measures, except those made necessary by the Contractor's own negligence or for his own convenience, will be paid for at the appropriate contract unit price for the devices or measures utilized in borrow sources and waste areas.

No additional payment will be made for erosion control devices or permanent seeding and mulching in any commercial borrow or waste pit. All erosion and sediment control practices that may be required on a commercial borrow or waste site will be done at the Contractor's expense.

All offsite Staging Areas, Borrow and Waste sites shall be in accordance with “Borrow and Waste Site Reclamation Procedures for Contracted Projects” located at:

<https://connect.ncdot.gov/resources/roadside/FieldOperationsDocuments/ContractedReclamationProcedures.pdf>

All forms and documents referenced in the “Borrow and Waste Site Reclamation Procedures for Contracted Projects” shall be included with the reclamation plans for offsite staging areas, and borrow and waste sites.

SAFETY FENCE AND JURISDICTIONAL FLAGGING:

Description

Safety Fence shall consist of furnishing materials, installing and maintaining polyethylene or polypropylene fence along the outside riparian buffer, wetland, or water boundary, or other boundaries located within the construction corridor to mark the areas that have been approved to infringe within the buffer, wetland, endangered vegetation, culturally sensitive areas or water. The fence shall be installed prior to any land disturbing activities.

Interior boundaries for jurisdictional areas noted above shall be delineated by stakes and highly visible flagging.

Jurisdictional boundaries at staging areas, waste sites, or borrow pits, whether considered outside or interior boundaries shall be delineated by stakes and highly visible flagging.

Materials

(A) Safety Fencing

Polyethylene or polypropylene fence shall be a highly visible preconstructed safety fence approved by the Engineer. The fence material shall have an ultraviolet coating.

Either wood posts or steel posts may be used. Wood posts shall be hardwood with a wedge or pencil tip at one end, and shall be at least 5 ft. in length with a minimum nominal 2" x 2" cross section. Steel posts shall be at least 5 ft. in length, and have a minimum weight of 0.85 lb/ft of length.

(B) Boundary Flagging

Wooden stakes shall be 4 feet in length with a minimum nominal 3/4" x 1-3/4" cross section. The flagging shall be at least 1" in width. The flagging material shall be vinyl and shall be orange in color and highly visible.

Construction Methods

No additional clearing and grubbing is anticipated for the installation of this fence. The fence shall be erected to conform to the general contour of the ground.

(A) Safety Fencing

Posts shall be set at a maximum spacing of 10 ft., maintained in a vertical position and hand set or set with a post driver. Posts shall be installed a minimum of 2 ft. into the ground. If hand set, all backfill material shall be thoroughly tamped. Wood posts may be sharpened to a dull point if power driven. Posts damaged by power driving shall be removed and replaced prior to final acceptance. The tops of all wood posts shall be cut at a 30-degree angle. The wood posts may, at the option of the Contractor, be cut at this angle either before or after the posts are erected.

The fence geotextile shall be attached to the wood posts with one 2" galvanized wire staple across each cable or to the steel posts with wire or other acceptable means.

Place construction stakes to establish the location of the safety fence in accordance with Article 105-9 or Article 801-1 of the *Standard Specifications*. No direct pay will be made for the staking of the safety fence. All stakeouts for safety fence shall be considered incidental to the work being paid for as "Construction Surveying", except that where there is no pay item for construction surveying, all safety fence stakeout will be performed by state forces.

The Contractor shall be required to maintain the safety fence in a satisfactory condition for the duration of the project as determined by the Engineer.

(B) Boundary Flagging

Boundary flagging delineation of interior boundaries shall consist of wooden stakes on 25 feet maximum intervals with highly visible orange flagging attached. Stakes shall be installed a minimum of 6" into the ground. Interior boundaries may be staked on a tangent that runs parallel to buffer but must not encroach on the buffer at any location. Interior boundaries of hand clearing shall be identified with a different colored flagging to distinguish it from mechanized clearing.

Boundary flagging delineation of interior boundaries will be placed in accordance with Article 105-9 or Article 801-1 of the *Standard Specifications*. No direct pay will be made for delineation of the interior boundaries. This delineation will be considered incidental to the work being paid for as *Construction Surveying*, except that where there is no pay item or construction surveying the cost of boundary flagging delineation shall be included in the unit prices bid for the various items in the contract. Installation for delineation of all jurisdictional boundaries at staging areas, waste sites, or borrow pits shall consist of wooden stakes on 25 feet maximum intervals with highly visible orange flagging attached. Stakes shall be installed a minimum of 6" into the ground. Additional flagging may be placed on overhanging vegetation to enhance visibility but does not substitute for installation of stakes.

Installation of boundary flagging for delineation of all jurisdictional boundaries at staging areas, waste sites, or borrow pits shall be performed in accordance with Subarticle 230-4(B)(5) or Subarticle 802-2(F) of the *Standard Specifications*. No direct pay will be made for this delineation, as the cost of same shall be included in the unit prices bid for the various items in the contract.

The Contractor shall be required to maintain alternative stakes and highly visible flagging in a satisfactory condition for the duration of the project as determined by the Engineer.

Measurement and Payment

Safety Fence will be measured and paid as the actual number of linear feet of polyethylene or polypropylene fence installed in place and accepted. Such payment will be full compensation including but not limited to furnishing and installing fence geotextile with necessary posts and post bracing, staples, tie wires, tools, equipment and incidentals necessary to complete this work.

Payment will be made under:

Pay Item
Safety Fence

Pay Unit
Linear Foot

SILT FENCE COIR FIBER WATTLE BREAK:

(8-21-12) 1605,1630

Description

Silt fence coir fiber wattle breaks are tubular products consisting of coir fibers (coconut fibers) encased in coir fiber netting and used in conjunction with temporary silt fence at the toe of fills to intercept runoff. Silt fence coir fiber wattle breaks are to be placed at locations shown on the plans or as directed. Installation shall follow the detail provided in the plans and as directed. Work includes furnishing materials, installation, maintenance and removing Silt fence coir fiber wattle breaks.

Materials

Coir fiber wattle shall meet the following specifications:

100% Coir (Coconut) Fibers	
Minimum Diameter	12"
Minimum Length	10 ft
Minimum Density	3.5 lb/cf \pm 10%
Net Material	Coir Fiber
Net Openings	2" x 2"
Net Strength	90 lb.
Minimum Weight	2.6 lb/ft \pm 10%

Stakes shall be used as anchors. Provide hardwood stakes a minimum of 2-ft long with a 2" x 2" nominal square cross section. One end of the stake shall be sharpened or beveled to facilitate driving down into the underlying soil.

Provide staples made of 0.125" diameter new steel wire formed into a U-shape not less than 12" in length with a throat of 1" in width.

Construction Methods

Excavate a trench the entire length of each wattle with a depth of 1" to 2" for the wattle to be placed. Secure silt fence coir fiber wattle breaks to the soil by wire staples approximately every linear foot and at the end of each wattle. Install at least 4 stakes on the downslope side of the wattle with a maximum spacing of 2 linear feet and according to the detail. Install at least 2 stakes on the upslope side of the silt fence coir fiber wattle break according to the detail provided in the plans. Drive stakes into the ground at least 10" with no more than 2" projecting from the top of the wattle. Drive stakes at an angle according to the detail provided in the plans.

Install temporary silt fence in accordance with Section 1605 of the *Standard Specifications* and overlap each downslope side of silt fence wattle break by 6".

Maintain the silt fence coir fiber wattle breaks until the project is accepted or until the silt fence coir fiber wattle breaks are removed, and remove and dispose of silt accumulations at the silt fence coir fiber wattle breaks when so directed in accordance with Section 1630 of the *Standard Specifications*.

Measurement and Payment

Coir Fiber Wattle will be measured and paid as the actual number of linear feet of wattles installed and accepted. Such price and payment will be full compensation for all work covered by this provision, including, but not limited to, furnishing all materials, labor, equipment and incidentals necessary to install the silt fence coir fiber wattle break.

Payment will be made under:

Pay Item
Coir Fiber Wattle

Pay Unit
Linear Foot

TEMPORARY ROCK SILT CHECK TYPE A WITH EXCELSIOR MATTING AND POLYACRYLAMIDE (PAM):

Description

Temporary Rock Silt Checks Type A with Excelsior Matting and Polyacrylamide (PAM) are devices utilized in temporary and permanent ditches to reduce runoff velocity and incorporate PAM into the construction runoff to increase settling of sediment particles and reduce turbidity of runoff. Temporary Rock Silt Checks Type A with Excelsior Matting and PAM are to be placed at

locations shown on the plans or as directed. Installation shall follow the detail provided in the plans and as directed. Work includes furnishing materials, installation of Temporary Rock Silt Checks Type A, matting installation, PAM application, and removing Temporary Rock Silt Checks Type A with Excelsior Matting and PAM.

Materials

Structural stone shall be class B stone that meets the requirements of Section 1042 of the *Standard Specifications* for Stone for Erosion Control, Class B.

Sediment control stone shall be #5 or #57 stone, which meets the requirements of Section 1005 of the *Standard Specifications* for these stone sizes.

Matting shall meet the requirements of Excelsior Matting in Subarticle 1060-8(B) of the *Standard Specifications*, or shall meet specifications provided elsewhere in this contract.

Polyacrylamide (PAM) shall be applied in powder form and shall be anionic or neutrally charged. Soil samples shall be obtained in areas where the Temporary Rock Silt Checks Type A with Excelsior Matting and PAM will be placed, and from offsite material used to construct the roadway, and analyzed for the appropriate PAM flocculant to be utilized with each Temporary Rock Silt Check Type A. The PAM product used shall be listed on the North Carolina Department of Environmental Quality Division of Water Resources web site as an approved PAM product for use in North Carolina.

Construction Methods

Temporary Rock Silt Checks Type A shall be installed in accordance with Subarticle 1633-3(A) of the *Standard Specifications*, Roadway Standard Drawing No. 1633.01 and the detail provided in the plans.

Installation of matting shall be in accordance with the detail provided in the plans, and anchored by placing Class B stone on top of the matting at the upper and lower ends.

Apply PAM at a rate of 4 ounces over the center portion of the Temporary Rock Silt Checks Type A and matting where the water is going to flow over. PAM applications shall be done during construction activities and after every rainfall event that is equal to or exceeds 0.50 in.

The Contractor shall maintain the Temporary Rock Silt Checks Type A with Excelsior Matting and PAM until the project is accepted or until the Temporary Rock Silt Checks Type A with Excelsior Matting and PAM are removed, and shall remove and dispose of silt accumulations at the Temporary Rock Silt Checks Type A with Excelsior Matting and PAM when so directed in accordance with the requirements of Section 1630 of the *Standard Specifications*.

Measurement and Payment

Temporary Rock Silt Checks Type A will be measured and paid for in accordance with Article 1633-5 of the *Standard Specifications*, or in accordance with specifications provided elsewhere in this contract.

Matting will be measured and paid for in accordance with Article 1631-4 of the *Standard Specifications*, or in accordance with specifications provided elsewhere in this contract.

Polyacrylamide(PAM) will be measured and paid for by the actual weight in pounds of PAM applied to the Temporary Rock Silt Checks Type A. Such price and payment will be full compensation for all work covered by this section, including, but not limited to, furnishing all materials, labor, equipment and incidentals necessary to apply the *Polyacrylamide(PAM)*.

Payment will be made under:

Pay Item	Pay Unit
Polyacrylamide(PAM)	Pound

IMPERVIOUS DIKE:**Description**

This work consists of furnishing, installing, maintaining, and removing an *Impervious Dike* for the purpose of diverting normal stream flow around the construction site. The Contractor shall construct an impervious dike in such a manner approved by the Engineer. The impervious dike shall not permit seepage of water into the construction site or contribute to siltation of the stream. The impervious dike shall be constructed of an acceptable material in the locations noted on the plans or as directed.

Materials

Acceptable materials shall include but not be limited to sheet piles, sandbags, and/or the placement of an acceptable size stone lined with polypropylene or other impervious geotextile.

Earth material shall not be used to construct an impervious dike when it is in direct contact with the stream unless vegetation can be established before contact with the stream takes place.

Measurement and Payment

Impervious Dike will be measured and paid as the actual number of linear feet of impervious dike(s) constructed, measured in place from end to end of each separate installation that has been completed and accepted. Such price and payment will be full compensation for all work including but not limited to furnishing materials, construction, maintenance, and removal of the impervious dike.

Payment will be made under:

Pay Item	Pay Unit
Impervious Dike	Linear Foot

COIR FIBER MAT:

Description

Furnish material, install and maintain coir fiber mat in locations shown on the plans or in locations as directed. Work includes providing all materials, excavating and backfilling, and placing and securing coir fiber mat with stakes, steel reinforcement bars or staples as directed.

Materials

Item	Section
Coir Fiber Mat	1060-14

Anchors: Stakes, reinforcement bars, or staples shall be used as anchors.

Wooden Stakes:

Provide hardwood stakes 12"- 24" long with a 2" x 2" nominal square cross section. One end of the stake must be sharpened or beveled to facilitate driving through the coir fiber mat and down into the underlying soil. The other end of the stake needs to have a 1"- 2" long head at the top with a 1"- 2" notch following to catch and secure the coir fiber mat.

Steel Reinforcement Bars:

Provide uncoated #10 steel reinforcement bars 24" nominal length. The bars shall have a 4" diameter bend at one end with a 4" straight section at the tip to catch and secure the coir fiber mat.

Staples:

Provide staples made of 0.125" diameter new steel wire formed into a *u* shape not less than 12" in length with a throat of 1" in width.

Construction Methods

Place the coir fiber mat immediately upon final grading. Provide a smooth soil surface free from stones, clods, or debris that will prevent the contact of the mat with the soil. Unroll the mat and apply without stretching such that it will lie smoothly but loosely on the soil surface.

For stream relocation applications, take care to preserve the required line, grade, and cross section of the area covered. Bury the top slope end of each piece of mat in a narrow trench at least 6 in.

deep and tamp firmly. Where one roll of matting ends and a second roll begins, overlap the end of the upper roll over the buried end of the second roll so there is a 6 in. overlap. Construct check trenches at least 12 in. deep every 50 ft. longitudinally along the edges of the mat or as directed. Fold over and bury mat to the full depth of the trench, close and tamp firmly. Overlap mat at least 6 in. where 2 or more widths of mat are installed side by side.

Place anchors across the mat at the ends approximately 1 ft. apart. Place anchors along the outer edges and down the center of the mat 3 ft. apart.

Adjustments in the trenching or anchoring requirements to fit individual site conditions may be required.

Measurement and Payment

Coir Fiber Mat will be measured and paid for as the actual number of square yards measured along the surface of the ground over which coir fiber mat is installed and accepted.

No measurement will be made for anchor items.

Payment will be made under:

Pay Item	Pay Unit
Coir Fiber Mat	Square Yard

CONCRETE WASHOUT STRUCTURE:

(01-03-19)

Description

Concrete washout structures are enclosures above or below grade to contain concrete waste water and associated concrete mix from washing out ready-mix trucks, drums, pumps, or other equipment. Concrete washouts must collect and retain all the concrete washout water and solids, so that this material does not migrate to surface waters or into the ground water. These enclosures are not intended for concrete waste not associated with wash out operations.

The concrete washout structure may include constructed devices above or below ground and or commercially available devices designed specifically to capture concrete wash water.

Materials

Item	Section
Temporary Silt Fence	1605

Safety Fence shall meet the specifications as provided elsewhere in this contract.

Geomembrane basin liner shall meet the following minimum physical properties for low permeability; it shall consist of a polypropylene or polyethylene 10 mil thick geomembrane. If the minimum setback dimensions can be achieved the liner is not required. (5 feet above groundwater, 50 feet from top of bank of perennial stream, other surface water body, or wetland.)

Construction Methods

Build an enclosed earthen berm or excavate to form an enclosure in accordance with the details and as directed.

Install temporary silt fence around the perimeter of the enclosure in accordance with the details and as directed if structure is not located in an area where existing erosion and sedimentation control devices are capable to containing any loss of sediment.

Post a sign with the words “Concrete Washout” in close proximity of the concrete washout area, so it is clearly visible to site personnel. Install safety fence as directed for visibility to construction traffic.

The construction details for the above grade and below grade concrete washout structures can be found on the following web page link:

<https://connect.ncdot.gov/resources/roadside/SoilWaterDocuments/ConcreteWashoutStructuredetail.pdf>

Alternate details for accommodating concrete washout may be submitted for review and approval.

The alternate details shall include the method used to retain and dispose of the concrete waste water within the project limits and in accordance with the minimum setback requirements. (5 feet above groundwater, 50 feet from top of bank of perennial stream, other surface water body, or wetland.)

Maintenance and Removal

Maintain the concrete washout structure(s) to provide adequate holding capacity plus a minimum freeboard of 12 inches. Remove and dispose of hardened concrete and return the structure to a functional condition after reaching 75% capacity.

Inspect concrete washout structures for damage and maintain for effectiveness.

Remove the concrete washout structures and sign upon project completion. Grade the earth material to match the existing contours and permanently seed and mulch area.

Measurement and Payment

Concrete Washout Structure will be paid for per each enclosure installed in accordance with the details. If alternate details are approved then those details will also be paid for per each approved and installed device.

Temporary Silt Fence will be measured and paid for in accordance with Article 1605-5 of the *Standard Specifications*.

No measurement will be made for other items or for over excavation or stockpiling.

Payment will be made under:

Pay Item	Pay Unit
Concrete Washout Structure	Each

PUMP AROUND OPERATION:**Description**

The work covered by this section consists of furnishing, installing, maintaining and removing any and all pump around systems used on this project. The Contractor shall install a pump around system in locations as shown in the plans and in other locations approved by the Engineer. The pump around system shall provide a passageway for the stream flow around the work site.

The quantity of pump around systems may be increased, decreased, or eliminated entirely as directed. Such variations in quantity will not be considered as alterations in the details of construction or a change in the character of the work. See NCDOT *Best Management Practices for Construction and Maintenance Activities* manual for example pump around operation.

Materials

Item	Section
Special Stilling Basin	1639

Impervious Dike shall meet the specifications as provided elsewhere in this contract.

Pumps shall be of sufficient size to divert the stream flow around the work area, as approved by the Engineer.

Construction Methods

Install *impervious dike(s)* as shown on the plans or as directed. Pump water around the work site. If the water is turbid or exposed to bare soil, pump through a *special stilling basin*. Once the work is complete in an area remove the *impervious dike(s)* and pump system, and stabilize the area.

Measurement and Payment

Impervious Dike will be measured and paid for as provided elsewhere in this contract.

Special Stilling Basin will be measured and paid for in accordance with Article 1639-4 of the *Standard Specifications*.

Payment for pumping operations shall be considered incidental to the work of installing pipes and culverts. The pumping operations shall include but not be limited to, diverting the stream flow around the work area and pumping runoff from the work area into a stilling basin, special stilling basin or other sediment control device. No additional payment will be made for furnishing materials or maintenance of the pumping operations for the installation of pipes and culverts.

The above prices and payments will be full compensation for all work covered by this section including, but not limited to furnishing all of the necessary materials, construction, maintenance and removal of the impervious dike and pump around system.

FABRIC INSERT INLET PROTECTION DEVICE

(6-29-17)

Description

This work shall consist of installing, maintaining, and removing *Fabric Inlet Protection Device*, of the type specified, in inlet structures (catch basins, drop inlets, etc) in areas where asphalt or concrete may not be fully removed in lieu Rock Inlet Sediment Traps Type C, or as directed.

Materials

The product shall be a fabric inlet protection device composed of a fitted woven polypropylene geotextile double sewn with nylon thread suspended sack. The *Fabric Inlet Protection Device* shall be manufactured to fit the opening of the catch basin or drop inlet or shall have a deflector to direct runoff from the curb opening into the fabric sack. The *Fabric Inlet Protection Device* shall have a rigid frame or support system to support the loaded weight of the product. The product shall have lifting loops for removing the device from the basin and will have dump straps attached at the bottom to facilitate the emptying of the device. The *Fabric Inlet Protection Device* shall have an overflow system to allow stormwater to enter the inlet structure and avoid ponding on the roadway when the device reaches capacity.

The stitching shall meet the following physical properties:

Physical	Test Method	English
Average Wide Width Strength	ASTM D-4884	165 lb/in

The fitted filter assembly shall have the following physical properties:

Physical	Test Method	English
----------	-------------	---------

Grab Tensile	ASTM D-4632	315 x 300 lbs
Grab Elongation	ASTM D-4632	15 x 15 %
Minimum Puncture Strength	ASTM D-4833	125 lbs
Mullen Burst	ASTM D-3786	650 PSI
Minimum UV Resistance	ASTM D-4355	90 %.
Flow Rate	ASTM D-4491	40 gal/min/ft ²
Apparent Opening	ASTM D-4751	40 US Sieve
Permittivity	ASTM D-4491	0.55 sec ⁻¹

Construction Methods

Strictly comply with manufacturer's installation instructions and recommendations. Maintenance shall include regular daily inspections and after each qualifying rain event. The *Fabric Insert Inlet Protection Device* shall be emptied, cleaned and placed back into the basin when it reaches 50% capacity or as directed.

Measurement and Payment

This work will be paid for at the contract unit price per *Fabric Insert Inlet Protection Device* of the type specified, complete in place and accepted. Such payment shall be full compensation for furnishing and installing the *Fabric Insert Inlet Protection Device* in accordance with this specification and for all required maintenance.

Maintenance of the device, cleanout and disposal of accumulated sediments shall be paid for by *Fabric Insert Inlet Protection Device Cleanout*.

Payment will be made under:

Pay Item	Pay Unit
Fabric Insert Inlet Protection Device	Each
Fabric Insert Inlet Protection Device Cleanout	Each

VERTICAL PANEL TYPE 3 OBJECT MARKER – OM3-L:

(07-23-18)

(A) General

Provide a vertical marker with sheeting for a Vertical Panel Type 3 Object Marker – OM3-L. The vertical marker post shall be affixed to a base capable of restoring the marker to the vertical position if struck by a vehicle.

(B) Crash Testing

The vertical panel shall be crash tested and meet requirements for a NCHRP 350 or MASH-16 Category II device. The vertical marker shall be capable of sustaining a minimum of twenty (20) direct wheel-over impacts at 55 MPH without damage to the vertical marker or reflective sheeting applied to the vertical marker.

(C) Construction

The vertical marker shall be composed of UV-stabilized high impact plastic. The vertical marker shall be a minimum of 12 inches wide and a minimum of 48 inches high when installed. The vertical marker will consist of a retro-reflective sheeting, flat panel, post and permanent base. The post shall be attached to the base with a flexible mount or similar device capable of restoring the marker to the vertical position if struck by a vehicle.

(D) Reflective Sheeting

The vertical marker flat panel shall accommodate a minimum of 12 inches x 36 inches of Grade C high intensity retro-reflective sheeting or better that meets the requirements of Section 1092. The retro-reflective sheeting shall meet the color and stripe patterns of a Vertical Panel Type 3 Object Marker – OM3-L per requirements of the 2009 MUTCD.

(E) Installation

The vertical marker shall be installed per manufacturer’s instructions.

(F) Approval

All materials are subject to the approval of the Engineer.

(D) Measurement and Payment

Payment will be made under:

Pay Item

Vertical Panel Type 3 Object Marker – OM3-L

Pay Unit

each

Ron King
12/5/2019



U-5710A

TS-1

New Hanover County

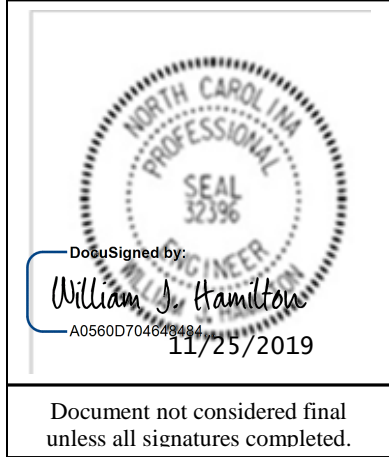

**Signals and Intelligent Transportation Systems
 Project Special Provisions
 (Version 18.2)**

*Prepared By: WJH
 25-Nov-19*

Contents

1. 2018 STANDARD SPECIFICATIONS FOR ROADS & STRUCTURES.....3

1.1. GENERAL REQUIREMENTS – CONSTRUCTION METHODS (1700-3(K)) 3

1.2. WOOD POLES – CONSTRUCTION METHODS (1720-3) 3

2. SIGNAL HEADS.....3

2.1. MATERIALS 3

A. General:..... 3

B. Vehicle Signal Heads:..... 5

C. Pedestrian Signal Heads: 7

D. Signal Cable: 9

3. CONTROLLERS WITH CABINETS9

3.1. MATERIALS – GENERAL CABINETS 9

3.2. MATERIALS – TYPE 170E CABINETS 10

A. Type 170 E Cabinets General:..... 10

B. Type 170 E Cabinet Electrical Requirements:..... 10

C. Type 170 E Cabinet Physical Requirements:..... 17

D. Model 2018 Enhanced Conflict Monitor: 18

E. Preemption and Sign Control Box 28

3.3. MATERIALS – TYPE 170 DETECTOR SENSOR UNITS 31

3.4. MATERIALS – TYPE 2070E CONTROLLERS 31

4. MICROWAVE VEHICLE DETECTION SYSTEM - MULTIPLE DETECTION ZONES.....31

4.1. DESCRIPTION 31

4.2. MATERIALS 31

4.3. CONSTRUCTION METHODS 32

4.4. MEASUREMENT AND PAYMENT 33

5. TRAFFIC SIGNAL SUPPORTS.....33

5.1. METAL TRAFFIC SIGNAL SUPPORTS – ALL POLES 33

A. General:..... 33

B. Materials: 35

C. Construction Methods: 36

5.2. METAL POLE UPRIGHTS (VERTICAL MEMBERS) 37

A. Materials: 37

B. Construction Methods: 38

5.3. MAST ARMS..... 38

A. Materials: 39

B. Construction Methods: 39

5.4. DRILLED PIER FOUNDATIONS FOR METAL TRAFFIC SIGNAL POLES..... 39

A. Description: 40

B. Soil Test and Foundation Determination: 40

- C. *Drilled Pier Construction:* 43
- 5.5. CUSTOM DESIGN OF TRAFFIC SIGNAL SUPPORTS 43
 - A. *General:* 43
 - B. *Metal Poles:* 44
 - C. *Mast Arms:* 46
- 5.6. METAL SIGNAL POLE REMOVALS 46
 - A. *Description:* 46
 - B. *Construction Methods:* 46
- 5.7. POLE NUMBERING SYSTEM 47
 - A. *New Poles* 47
- 5.8. MEASUREMENT AND PAYMENT 47
- 6. PROTECTIVE COATING FOR METAL POLES 47**
 - 6.1. DESCRIPTION 47
 - 6.2. MATERIALS 48
 - 6.3. COATING SHOP APPROVAL 48
 - 6.4. POWDER COATING 49
 - A. *Galvanizing:* 49
 - B. *Surface Preparation:* 49
 - C. *Powder Coating Application and Curing* 50
 - D. *Quality Control:* 50
 - E. *Storage, Shipping, and Handling:* 50
 - F. *Repair of Powder Coated Material:* 50
 - 6.5. ACRYLIC PRIMER AND TOP COAT PAINT SYSTEM 4 (MODIFIED) 50
 - A. *Description* 50
 - B. *Surface Preparation:* 51
 - C. *Materials:* 51
 - D. *Painting* 51
 - E. *Curing* 52
 - F. *Inspection:* 52
 - G. *Handling* 52
 - H. *Repair of Damaged Coating:* 52
 - 6.6. MEASUREMENT AND PAYMENT 53
- 7. BACK PULL FIBER OPTIC CABLE 53**
 - 7.1. DESCRIPTION 53
 - 7.1. CONSTRUCTION 53
 - 7.2. MEASUREMENT AND PAYMENT 53
- 8. DROP CABLE ASSEMBLY 53**
 - 8.1. DESCRIPTION 53
 - 8.2. MATERIALS 54
 - 8.3. CONSTRUCTION METHODS 54
 - 8.4. MEASUREMENT AND PAYMENT 55

1. 2018 STANDARD SPECIFICATIONS FOR ROADS & STRUCTURES

The 2018 Standard Specifications are revised as follows:

1.1. GENERAL REQUIREMENTS – Construction Methods (1700-3(K))

Page 17-4, revise sentence starting on line 14 to read “Modify existing electrical services, as necessary, to meet the grounding requirements of the NEC, these *Standard Specifications*, *Standard Drawings*, and the project plans.”

Page 17-4, revise sentence beginning on line 21 to read “Furnish and install additional ground rods to grounding electrode system as necessary to meet the *Standard Specifications*, *Standard Drawings*, and test requirements.”

1.2. WOOD POLES – Construction Methods (1720-3)

Page 17-18, revise sentence starting on line 13 to read “On new Department-owned poles, install a grounding system consisting of #6 AWG solid bare copper wire that is mechanically crimped using an irreversible compression tool with die to a single ground rod installed at base of pole or to the electrical service grounding electrode system located within 10 feet of the pole.”

2. SIGNAL HEADS

2.1. MATERIALS

A. General:

Fabricate vehicle signal head housings and end caps from die-cast aluminum. Fabricate 16-inch pedestrian signal head housings and end caps from die-cast aluminum. Provide visor mounting screws, door latches, and hinge pins fabricated from stainless steel. Provide interior screws, fasteners, and metal parts fabricated from stainless steel.

Fabricate tunnel and traditional visors from sheet aluminum.

Paint all surfaces inside and outside of signal housings and doors. Paint outside surfaces of tunnel and traditional visors, wire outlet bodies, wire entrance fitting brackets and end caps when supplied as components of messenger cable mounting assemblies, pole and pedestal mounting assemblies, and pedestrian pushbutton housings. Have electrostatically-applied, fused-polyester paint in highway yellow (Federal Standard 595C, Color Chip Number 13538) a minimum of 2.5 to 3.5 mils thick. Do not apply paint to the latching hardware, rigid vehicle signal head mounting brackets for mast-arm attachments, messenger cable hanger components or balance adjuster components.

Have the interior surfaces of tunnel and traditional visors painted an alkyd urea black synthetic baking enamel with a minimum gloss reflectance and meeting the requirements of MIL-E-10169, “Enamel Heat Resisting, Instrument Black.”

Where required, provide polycarbonate signal heads and visors that comply with the provisions pertaining to the aluminum signal heads listed on the QPL with the following exceptions:

Fabricate signal head housings, end caps, and visors from virgin polycarbonate material. Provide UV stabilized polycarbonate plastic with a minimum thickness of 0.1 ± 0.01 inches that is highway yellow (Federal Standard 595C, Color Chip 13538). Ensure the color is incorporated into the plastic material before molding the signal head housings and end caps. Ensure the plastic formulation provides the following physical properties in the assembly (tests may be performed on separately molded specimens):

U-5710A

TS-4

New Hanover County

Test	Required	Method
Specific Gravity	1.17 minimum	ASTM D 792
Flammability	Self-extinguishing	ASTM D 635
Tensile Strength, yield, PSI	8500 minimum	ASTM D 638
Izod impact strength, ft-lb/in [notched, 1/8 inch]	12 minimum	ASTM D 256

For pole mounting, provide side of pole mounting assemblies with framework and all other hardware necessary to make complete, watertight connections of the signal heads to the poles and pedestals. Fabricate the mounting assemblies and frames from aluminum with all necessary hardware, screws, washers, etc. to be stainless steel. Provide mounting fittings that match the positive locking device on the signal head with the serrations integrally cast into the brackets. Provide upper and lower pole plates that have a 1 ¼-inch vertical conduit entrance hubs with the hubs capped on the lower plate and 1 ½-inch horizontal hubs. Ensure that the assemblies provide rigid attachments to poles and pedestals so as to allow no twisting or swaying of the signal heads. Ensure that all raceways are free of sharp edges and protrusions and can accommodate a minimum of ten Number 14 AWG conductors.

For pedestal mounting, provide a post-top slipfitter mounting assembly that matches the positive locking device on the signal head with serrations integrally cast into the slipfitter. Provide stainless steel hardware, screws, washers, etc. Provide a minimum of six 3/8 X 3/4-inch long square head bolts for attachment to pedestal. Provide a center post for multi-way slipfitters.

For light emitting diode (LED) traffic signal modules, provide the following requirements for inclusion on the Department's Qualified Products List for traffic signal equipment.

1. Sample submittal,
2. Third-party independent laboratory testing results for each submitted module with evidence of testing and conformance with all of the Design Qualification Testing specified in section 6.4 of each of the following Institute of Transportation Engineers (ITE) specifications:
 - Vehicle Traffic Control Signal Heads – Light Emitting Diode (LED) Circular Signal Supplement
 - Vehicle Traffic Control Signal Heads – Light Emitting Diode (LED) Vehicle Arrow Traffic Signal Supplement
 - Pedestrian Traffic Control Signal Indications –Light Emitting Diode (LED) Signal Modules.

(Note: The Department currently recognizes two approved independent testing laboratories. They are Intertek ETL Semko and Light Metrics, Incorporated with Garwood Laboratories. Independent laboratory tests from other laboratories may be considered as part of the QPL submittal at the discretion of the Department,

3. Evidence of conformance with the requirements of these specifications,
4. A manufacturer's warranty statement in accordance with the required warranty, and
5. Submittal of manufacturer's design and production documentation for the model, including but not limited to, electrical schematics, electronic component values, proprietary part numbers, bill of materials, and production electrical and photometric test parameters.

6. Evidence of approval of the product to bear the Intertek ETL Verified product label for LED traffic signal modules.

In addition to meeting the performance requirements for the minimum period of 60 months, provide a written warranty against defects in materials and workmanship for the modules for a period of 60 months after installation of the modules. During the warranty period, the manufacturer must provide new replacement modules within 45 days of receipt of modules that have failed at no cost to the State. Repaired or refurbished modules may not be used to fulfill the manufacturer's warranty obligations. Provide manufacturer's warranty documentation to the Department during evaluation of product for inclusion on Qualified Products List (QPL).

B. Vehicle Signal Heads:

Comply with the ITE standard "Vehicle Traffic Control Signal Heads". Provide housings with provisions for attaching backplates.

Provide visors that are 10 inches in length for 12-inch vehicle signal heads.

Provide a termination block with one empty terminal for field wiring for each indication plus one empty terminal for the neutral conductor. Have all signal sections wired to the termination block. Provide barriers between the terminals that have terminal screws with a minimum Number 8 thread size and that will accommodate and secure spade lugs sized for a Number 10 terminal screw.

Mount termination blocks in the yellow signal head sections on all in-line vehicle signal heads. Mount the termination block in the red section on five-section vehicle signal heads.

Furnish vehicle signal head interconnecting brackets. Provide one-piece aluminum brackets less than 4.5 inches in height and with no threaded pipe connections. Provide hand holes on the bottom of the brackets to aid in installing wires to the signal heads. Lower brackets that carry no wires and are used only for connecting the bottom signal sections together may be flat in construction.

For messenger cable mounting, provide messenger cable hangers, wire outlet bodies, balance adjusters, bottom caps, wire entrance fitting brackets, and all other hardware necessary to make complete, watertight connections of the vehicle signal heads to the messenger cable. Fabricate messenger cable hanger components, wire outlet bodies and balance adjuster components from stainless steel or malleable iron galvanized in accordance with ASTM A153 (Class A) or ASTM A123. Provide serrated rings made of aluminum. Provide messenger cable hangers with U-bolt clamps. Fabricate washers, screws, hex-head bolts and associated nuts, clevis pins, cotter pins, U-bolt clamps and nuts from stainless steel.

For mast-arm mounting, provide rigid vehicle signal head mounting brackets and all other hardware necessary to make complete, watertight connections of the vehicle signal heads to the mast arms and to provide a means for vertically adjusting the vehicle signal heads to proper alignment. Fabricate the mounting assemblies from aluminum, and provide serrated rings made of aluminum. Provide stainless steel cable attachment assemblies to secure the brackets to the mast arms. Ensure all fastening hardware and fasteners are fabricated from stainless steel.

Provide LED vehicular traffic signal modules (hereafter referred to as modules) that consist of an assembly that uses LEDs as the light source in lieu of an incandescent lamp for use in traffic signal sections. Use LEDs that are aluminum indium gallium phosphorus (AlInGaP) technology for red and yellow indications and indium gallium nitride (InGaN) for green indications. Install the ultra bright type LEDs that are rated for 100,000 hours of continuous operation from -40°F to +165°F. Design

modules to have a minimum useful life of 60 months and to meet all parameters of this specification during this period of useful life.

For the modules, provide spade terminals crimped to the lead wires and sized for a #10 screw connection to the existing terminal block in a standard signal head. Do not provide other types of crimped terminals with a spade adapter.

Ensure the power supply is integral to the module assembly. On the back of the module, permanently mark the date of manufacture (month & year) or some other method of identifying date of manufacture.

Tint the red, yellow and green lenses to correspond with the wavelength (chromaticity) of the LED. Transparent tinting films are unacceptable. Provide a lens that is integral to the unit with a smooth outer surface.

1. LED Circular Signal Modules:

Provide modules in the following configurations: 12-inch circular sections, and 8-inch circular sections. All makes and models of LED modules purchased for use on the State Highway System shall appear on the current NCDOT Traffic Signal Qualified Products List (QPL).

Provide the manufacturer's model number and the product number (assigned by the Department) for each module that appears on the 2018 or most recent Qualified Products List. In addition, provide manufacturer's certification in accordance with Article 106-3 of the *Standard Specifications*, that each module meets or exceeds the ITE "Vehicle Traffic Control Signal Heads – Light Emitting Diode (LED) Circular Signal Supplement" dated June 27, 2005 (hereafter referred to as VTCSH Circular Supplement) and other requirements stated in this specification.

Provide modules that meet the following requirements when tested under the procedures outlined in the VTCSH Circular Supplement:

Module Type	Max. Wattage at 165° F	Nominal Wattage at 77° F
12-inch red circular	17	11
12-inch green circular	15	15

For yellow circular signal modules, provide modules tested under the procedures outlined in the VTCSH Circular Supplement to insure power required at 77° F is 22 Watts or less for the 12-inch circular module and 13 Watts or less for the 8-inch circular module.

Note: Use a wattmeter having an accuracy of $\pm 1\%$ to measure the nominal wattage and maximum wattage of a circular traffic signal module. Power may also be derived from voltage, current and power factor measurements.

2. LED Arrow Signal Modules

Provide 12-inch omnidirectional arrow signal modules. All makes and models of LED modules purchased for use on the State Highway System shall appear on the current NCDOT Traffic Signal Qualified Products List (QPL).

Provide the manufacturer's model number and the product number (assigned by the Department) for each module that appears on the 2018 or most recent Qualified Products List. In addition, provide manufacturer's certification in accordance with Article 106-3 of the *Standard Specifications*, that each module meets or exceeds the requirements for 12-inch omnidirectional modules specified in the ITE

U-5710A**TS-7****New Hanover County**

“Vehicle Traffic Control Signal Heads – Light Emitting Diode (LED) Vehicle Arrow Traffic Signal Supplement” dated July 1, 2007 (hereafter referred to as VTCSH Arrow Supplement) and other requirements stated in this specification.

Provide modules that meet the following requirements when tested under the procedures outlined in the VTCSH Arrow Supplement:

Module Type	Max. Wattage at 165° F	Nominal Wattage at 77° F
12-inch red arrow	12	9
12-inch green arrow	11	11

For yellow arrow signal modules, provide modules tested under the procedures outlined in the VTCSH Arrow Supplement to insure power required at 77° F is 12 Watts or less.

Note: Use a wattmeter having an accuracy of $\pm 1\%$ to measure the nominal wattage and maximum wattage of an arrow traffic signal module. Power may also be derived from voltage, current and power factor measurements.

C. Pedestrian Signal Heads:

Provide pedestrian signal heads with international symbols that meet the MUTCD. Do not provide letter indications.

Comply with the ITE standard for “Pedestrian Traffic Control Signal Indications” and the following sections of the ITE standard for “Vehicle Traffic Control Signal Heads” in effect on the date of advertisement:

- Section 3.00 - “Physical and Mechanical Requirements”
- Section 4.01 - “Housing, Door, and Visor: General”
- Section 4.04 - “Housing, Door, and Visor: Materials and Fabrication”
- Section 7.00 - “Exterior Finish”

Provide a double-row termination block with three empty terminals and number 10 screws for field wiring. Provide barriers between the terminals that accommodate a spade lug sized for number 10 terminal screws. Mount the termination block in the hand section. Wire all signal sections to the terminal block.

Where required by the plans, provide 16-inch pedestrian signal heads with traditional three-sided, rectangular visors, 6 inches long.

Provide 2-inch diameter pedestrian push-buttons with weather-tight housings fabricated from die-cast aluminum and threading in compliance with the NEC for rigid metal conduit. Provide a weep hole in the housing bottom and ensure that the unit is vandal resistant.

Provide push-button housings that are suitable for mounting on flat or curved surfaces and that will accept 1/2-inch conduit installed in the top. Provide units that have a heavy duty push-button assembly with a sturdy, momentary, normally-open switch. Have contacts that are electrically insulated from the housing and push-button. Ensure that the push-buttons are rated for a minimum of 5 mA at 24 volts DC and 250 mA at 12 volts AC.

U-5710A**TS-8****New Hanover County**

Provide standard R10-3 signs with mounting hardware that comply with the MUTCD in effect on the date of advertisement. Provide R10-3E signs for countdown pedestrian heads and R10-3B for non-countdown pedestrian heads.

Design the LED pedestrian traffic signal modules (hereafter referred to as modules) for installation into standard pedestrian traffic signal sections that do not contain the incandescent signal section reflector, lens, eggcrate visor, gasket, or socket. Provide modules that consist of an assembly that uses LEDs as the light source in lieu of an incandescent lamp. Use LEDs that are of the latest aluminum indium gallium phosphorus (AlInGaP) technology for the Portland Orange hand and countdown displays. Use LEDs that are of the latest indium gallium nitride (InGaN) technology for the Lunar White walking man displays. Install the ultra-bright type LEDs that are rated for 100,000 hours of continuous operation from -40°F to +165°F. Design modules to have a minimum useful life of 60 months and to meet all parameters of this specification during this period of useful life.

Design all modules to operate using a standard 3 - wire field installation. Provide spade terminals crimped to the lead wires and sized for a #10 screw connection to the existing terminal block in a standard pedestrian signal housing. Do not provide other types of crimped terminals with a spade adapter.

Ensure the power supply is integral to the module assembly. On the back of the module, permanently mark the date of manufacture (month & year) or some other method of identifying date of manufacture.

Provide modules in the following configuration: 16-inch displays which have the solid hand/walking man overlay on the left and the countdown on the right, and 12-inch displays which have the solid hand/walking man module as an overlay. All makes and models of LED modules purchased for use on the State Highway System shall appear on the current NCDOT Traffic Signal Qualified Products List (QPL).

Provide the manufacturer's model number and the product number (assigned by the Department) for each module that appears on the 2018 or most recent Qualified Products List. In addition, provide manufacturer's certification in accordance with Article 106-3 of the *Standard Specifications*, that each module meets or exceeds the ITE "Pedestrian Traffic Control Signal Indicators - Light Emitting Diode (LED) Signal Modules" dated August 04, 2010 (hereafter referred to as PTCSI Pedestrian Standard) and other requirements stated in this specification.

Provide modules that meet the following requirements when tested under the procedures outlined in the PTCSI Pedestrian Standard:

Module Type	Max. Wattage at 165° F	Nominal Wattage at 77° F
Hand Indication	16	13
Walking Man Indication	12	9
Countdown Indication	16	13

Note: Use a wattmeter having an accuracy of $\pm 1\%$ to measure the nominal wattage and maximum wattage of a circular traffic signal module. Power may also be derived from voltage, current and power factor measurements.

Provide module lens that is hard coated or otherwise made to comply with the material exposure and weathering effects requirements of the Society of Automotive Engineers (SAE) J576. Ensure all

exposed components of the module are suitable for prolonged exposure to the environment, without appreciable degradation that would interfere with function or appearance.

Ensure the countdown display continuously monitors the traffic controller to automatically learn the pedestrian phase time and update for subsequent changes to the pedestrian phase time.

Ensure the countdown display begins normal operation upon the completion of the preemption sequence and no more than one pedestrian clearance cycle.

D. Signal Cable:

Furnish 16-4 and 16-7 signal cable that complies with IMSA specification 20-1 except provide the following conductor insulation colors:

- For 16-4 cable: white, yellow, red, and green
- For 16-7 cable: white, yellow, red, green, yellow with black stripe tracer, red with black stripe tracer, and green with black stripe tracer. Apply continuous stripe tracer on conductor insulation with a longitudinal or spiral pattern.

Provide a ripcord to allow the cable jacket to be opened without using a cutter. IMSA specification 19-1 will not be acceptable. Provide a cable jacket labeled with the IMSA specification number and provide conductors constructed of stranded copper.

3. CONTROLLERS WITH CABINETS

3.1.MATERIALS – GENERAL CABINETS

Provide a moisture resistant coating on all circuit boards.

Provide one 20 mm diameter radial lead UL-recognized metal oxide varistor (MOV) between each load switch field terminal and equipment ground. Electrical performance is outlined below.

PROPERTIES OF MOV SURGE PROTECTOR	
Maximum Continuous Applied Voltage at 185° F	150 VAC (RMS) 200 VDC
Maximum Peak 8x20µs Current at 185° F	6500 A
Maximum Energy Rating at 185° F	80 J
Voltage Range 1 mA DC Test at 77° F	212-268 V
Max. Clamping Voltage 8x20µs, 100A at 77° F	395 V
Typical Capacitance (1 MHz) at 77° F	1600 pF

Provide a power line surge protector that is a two-stage device that will allow connection of the radio frequency interference filter between the stages of the device. Ensure that a maximum continuous current is at least 10A at 120V. Ensure that the device can withstand a minimum of 20 peak surge current occurrences at 20,000A for an 8x20 microsecond waveform. Provide a maximum clamp

voltage of 395V at 20,000A with a nominal series inductance of 200 μ h. Ensure that the voltage does not exceed 395V. Provide devices that comply with the following:

Frequency (Hz)	Minimum Insertion Loss (dB)
60	0
10,000	30
50,000	55
100,000	50
500,000	50
2,000,000	60
5,000,000	40
10,000,000	20
20,000,000	25

3.2. MATERIALS – TYPE 170E CABINETS

A. Type 170 E Cabinets General:

Conform to the city of Los Angeles' Specification No. 54-053-08, *Traffic Signal Cabinet Assembly Specification* (dated July 2008), except as required herein.

Furnish model 332 base mounted cabinets configured for 8 vehicle phases, 4 pedestrian phases, and 6 overlaps. When overlaps are required, provide auxiliary output files for the overlaps. Do not reassign load switches to accommodate overlaps unless shown on electrical details.

Provide model 200 load switches, model 222 loop detector sensors, model 252 AC isolators, and model 242 DC isolators according to the electrical details. As a minimum, provide one (1) model 2018 conflict monitor, one (1) model 206L power supply unit, two (2) model 204 flashers, one (1) DC isolator (located in slot I14), and four (4) model 430 flash transfer relays (provide seven (7) model 430 flash transfer relays if auxiliary output file is installed) with each cabinet.

B. Type 170 E Cabinet Electrical Requirements:

Provide a cabinet assembly designed to ensure that upon leaving any cabinet switch or conflict monitor initiated flashing operation, the controller starts up in the programmed start up phases and start up interval.

Furnish two sets of non-fading cabinet wiring diagrams and schematics in a paper envelope or container and placed in the cabinet drawer.

All AC+ power is subject to radio frequency signal suppression.

Provide surge suppression in the cabinet for each type of cabinet device. Provide surge protection for the full capacity of the cabinet input file. Provide surge suppression devices that operate properly

U-5710A**TS-11****New Hanover County**

over a temperature range of -40° F to +185° F. Ensure the surge suppression devices provide both common and differential modes of protection.

Provide a pluggable power line surge protector that is installed on the back of the PDA (power distribution assembly) chassis to filter and absorb power line noise and switching transients. Ensure the device incorporates LEDs for failure indication and provides a dry relay contact closure for the purpose of remote sensing. Ensure the device meets the following specifications:

Peak Surge Current (Single pulse, 8x20µs).....	20,000A
Occurrences (8x20µs waveform).....	10 minimum @ 20,000A
Maximum Clamp Voltage.....	395VAC
Operating Current.....	15 amps
Response Time.....	< 5 nanoseconds

Provide a loop surge suppressor for each set of loop terminals in the cabinet. Ensure the device meets the following specifications:

Peak Surge Current (6 times, 8x20µs)	
(Differential Mode).....	400A
(Common Mode).....	1,000A
Occurrences (8x20µs waveform).....	500 min @ 200A
Maximum Clamp Voltage	
(Differential Mode @400A).....	35V
(Common Mode @1,000A).....	35V
Response Time.....	< 5 nanoseconds
Maximum Capacitance.....	35 pF

Provide a data communications surge suppressor for each communications line entering or leaving the cabinet. Ensure the device meets the following specifications:

Peak Surge Current (Single pulse, 8x20µs).....	10,000A
Occurrences (8x20µs waveform).....	100 min @ 2,000A
Maximum Clamp Voltage.....	Rated for equipment protected
Response Time.....	< 1 nanosecond
Maximum Capacitance.....	1,500 pF
Maximum Series Resistance.....	15Ω

U-5710A**TS-12****New Hanover County**

Provide a DC signal surge suppressor for each DC input channel in the cabinet. Ensure the device meets the following specifications:

Peak Surge Current (Single pulse, 8x20 μ s).....10,000A
 Occurrences (8x20 μ s waveform).....100 @ 2,000A
 Maximum Clamp Voltage.....30V
 Response Time.....< 1 nanosecond

Provide a 120 VAC signal surge suppressor for each AC+ interconnect signal input. Ensure the device meets the following specifications:

Peak Surge Current (Single pulse, 8x20 μ s).....20,000A
 Maximum Clamp Voltage.....350VAC
 Response Time.....< 200 nanoseconds
 Discharge Voltage.....<200 Volts @ 1,000A
 Insulation Resistance..... \geq 100 M Ω

Provide conductors for surge protection wiring that are of sufficient size (ampacity) to withstand maximum overcurrents which could occur before protective device thresholds are attained and current flow is interrupted.

If additional surge protected power outlets are needed to accommodate fiber transceivers, modems, etc., install a UL listed, industrial, heavy-duty type power outlet strip with a minimum rating of 15 A / 125 VAC, 60 Hz. Provide a strip that has a minimum of 3 grounded outlets. Ensure the power outlet strip plugs into one of the controller unit receptacles located on the rear of the PDA. Ensure power outlet strip is mounted securely; provide strain relief if necessary.

Provide a door switch in the front and a door switch in the rear of the cabinet that will provide the controller unit with a Door Ajar alarm when either the front or the rear door is open. Ensure the door switches apply DC ground to the Input File when either the front door or the rear door is open.

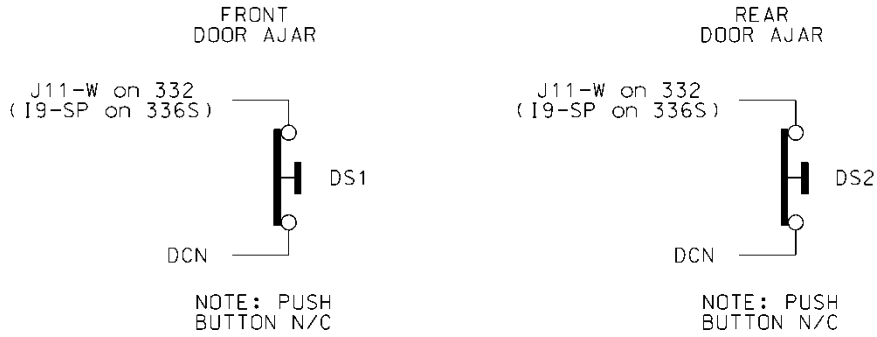

Furnish a fluorescent fixture in the rear across the top of the cabinet and another fluorescent fixture in the front across the top of the cabinet at a minimum. Ensure that the fixtures provide sufficient light to illuminate all terminals, labels, switches, and devices in the cabinet. Conveniently locate the fixtures so as not to interfere with a technician’s ability to perform work on any devices or terminals in the cabinet. Provide a protective diffuser to cover exposed bulbs. Install 16 watt T-4 lamps in the fluorescent fixtures. Provide a door switch to provide power to each fixture when the respective door is open. Wire the fluorescent fixtures to the 15 amp ECB (equipment circuit breaker).

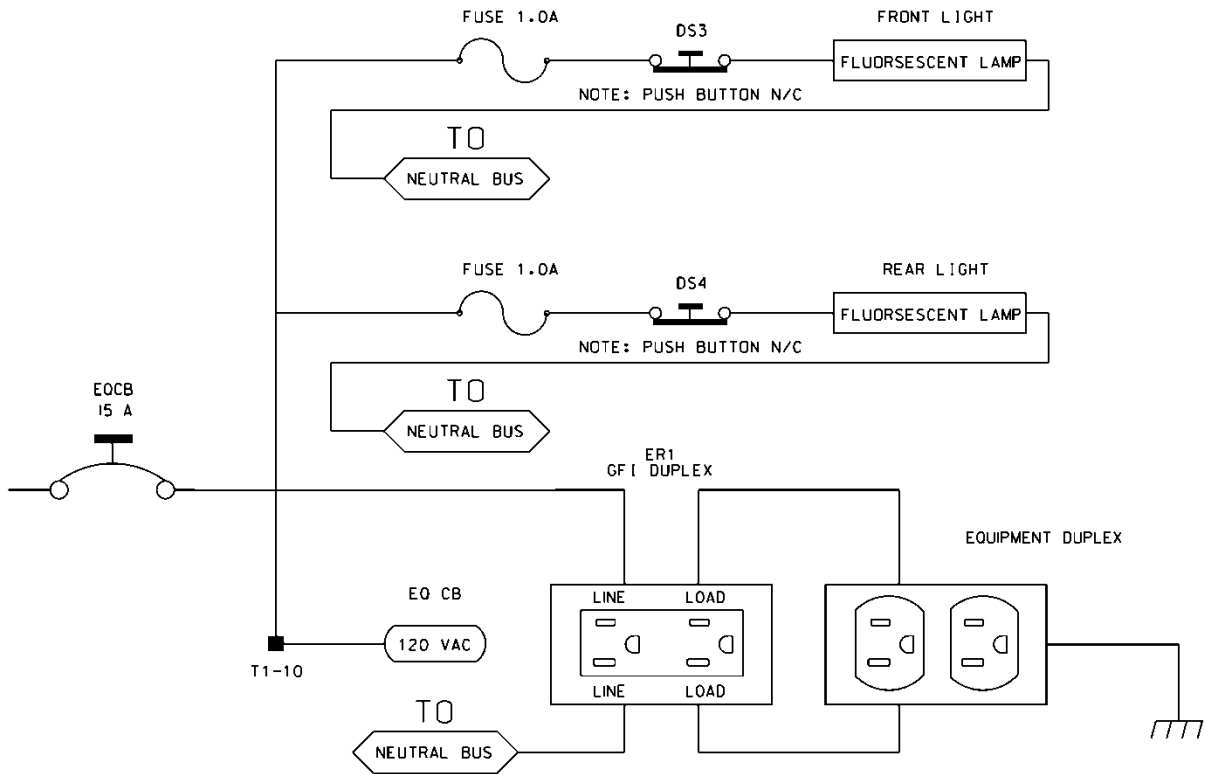

Furnish a police panel with a police panel door. Ensure that the police panel door permits access to the police panel when the main door is closed. Ensure that no rainwater can enter the cabinet even with the police panel door open. Provide a police panel door hinged on the right side as viewed from the front. Provide a police panel door lock that is keyed to a standard police/fire call box key. In addition to the requirements of LA Specification No. 54-053-08, provide the police panel with a toggle

switch connected to switch the intersection operation between normal stop-and-go operation (AUTO) and manual operation (MANUAL). Ensure that manual control can be implemented using inputs and software such that the controller provides full programmed clearance times for the yellow clearance and red clearance for each phase while under manual control.

Provide a 1/4-inch locking phone jack in the police panel for a hand control to manually control the intersection. Provide sufficient room in the police panel for storage of a hand control and cord.

For model 332 base mounted cabinets, ensure terminals J14-E and J14-K are wired together on the rear of the Input File. Connect TB9-12 (J14 Common) on the Input Panel to T1-2 (AC-) on the rear of the PDA.

Provide detector test switches mounted at the top of the cabinet rack or other convenient location which may be used to place a call on each of eight phases based on the chart below. Provide three positions for each switch: On (place call), Off (normal detector operation), and Momentary On (place momentary call and return to normal detector operation after switch is released). Ensure that the switches are located such that the technician can read the controller display and observe the intersection.

Connect detector test switches for cabinets as follows:

332 Cabinet	
Detector Call Switches	Terminals
Phase 1	I1-W
Phase 2	I4-W
Phase 3	I5-W
Phase 4	I8-W
Phase 5	J1-W
Phase 6	J4-W
Phase 7	J5-W
Phase 8	J8-W

Provide the PCB 28/56 connector for the conflict monitor unit (CMU) with 28 independent contacts per side, dual-sided with 0.156 inch contact centers. Provide the PCB 28/56 connector contacts with solder eyelet terminations. Ensure all connections to the PCB 28/56 connector are soldered to the solder eyelet terminations.

Ensure that all cabinets have the CMU connector wired according to the 332 cabinet connector pin assignments (include all wires for auxiliary output file connection). Wire pins 13, 16, R, and U of the CMU connector to a separate 4 pin plug, P1, as shown below. Provide a second plug, P2, which will mate with P1 and is wired to the auxiliary output file as shown below. Provide an additional plug, P3, which will mate with P1 and is wired to the pedestrian yellow circuits as shown below. When no auxiliary output file is installed in the cabinet, provide wires for the green and yellow inputs for channels 11, 12, 17, and 18, the red inputs for channels 17 and 18, and the wires for the P2 plug. Terminate the two-foot wires with ring type lugs, insulated, and bundled for optional use.

U-5710A

TS-15

New Hanover County

PIN	P1		P2		P3	
	FUNCTION	CONN TO	FUNCTION	CONN TO	FUNCTION	CONN TO
1	CH-9G	CMU-13	OLA-GRN	A123	2P-YEL	114
2	CH-9Y	CMU-16	OLA-YEL	A122	4P-YEL	105
3	CH-10G	CMU-R	OLB-GRN	A126	6P-YEL	120
4	CH-10Y	CMU-U	OLB-YEL	A125	8P-YEL	111

Do not provide the P20 terminal assembly (red monitor board) or red interface ribbon cable as specified in LA Specification No. 54-053-08.

Provide a P20 connector that mates with and is compatible with the red interface connector mounted on the front of the conflict monitor. Ensure that the P20 connector and the red interface connector on the conflict monitor are center polarized to ensure proper connection. Ensure that removal of the P20 connector will cause the conflict monitor to recognize a latching fault condition and place the cabinet into flashing operation.

Wire the P20 connector to the output file and auxiliary output file using 22 AWG stranded wires. Ensure the length of these wires is a minimum of 42 inches in length. Provide a durable braided sleeve around the wires to organize and protect the wires.

Wire the P20 connector to the traffic signal red displays to provide inputs to the conflict monitor as shown below. Ensure the pedestrian Don't Walk circuits are wired to channels 13 through 16 of the P20 connector. When no auxiliary output file is installed in the cabinet, provide wires for channels 9 through 12 reds. Provide a wire for special function 1. Terminate the unused wires with ring type lugs, insulated, and bundled for optional use.

P20 Connector					
PIN	FUNCTION	CONN TO	PIN	FUNCTION	CONN TO
1	Channel 15 Red	119	2	Channel 16 Red	110
3	Channel 14 Red	104	4	Chassis GND	01-9
5	Channel 13 Red	113	6	N/C	
7	Channel 12 Red	AUX 101	8	Spec Function 1	
9	Channel 10 Red	AUX 124	10	Channel 11 Red	AUX 114
11	Channel 9 Red	AUX 121	12	Channel 8 Red	107
13	Channel 7 Red	122	14	Channel 6 Red	134
15	Channel 5 Red	131	16	Channel 4 Red	101
17	Channel 3 Red	116	18	Channel 2 Red	128
19	Channel 1 Red	125	20	Red Enable	01-14

Ensure the controller unit outputs to the auxiliary output file are pre-wired to the C5 connector. When no auxiliary output file is installed in the cabinet, connect the C5 connector to a storage socket located on the Input Panel or on the rear of the PDA.

Do not wire pin 12 of the load switch sockets.

In addition to the requirements of LA Specification No. 54-053-08, ensure relay K1 on the Power Distribution Assembly (PDA) is a four pole relay and K2 on the PDA is a two pole relay.

Provide a two pole, ganged circuit breaker for the flash bus circuit. Ensure the flash bus circuit breaker is an inverse time circuit breaker rated for 10 amps at 120 VAC with a minimum of 10,000 RMS symmetrical amperes short circuit current rating. Do not provide the auxiliary switch feature on the flash bus circuit breaker. Ensure the ganged flash bus circuit breaker is certified by the circuit breaker manufacturer to provide gang tripping operation.

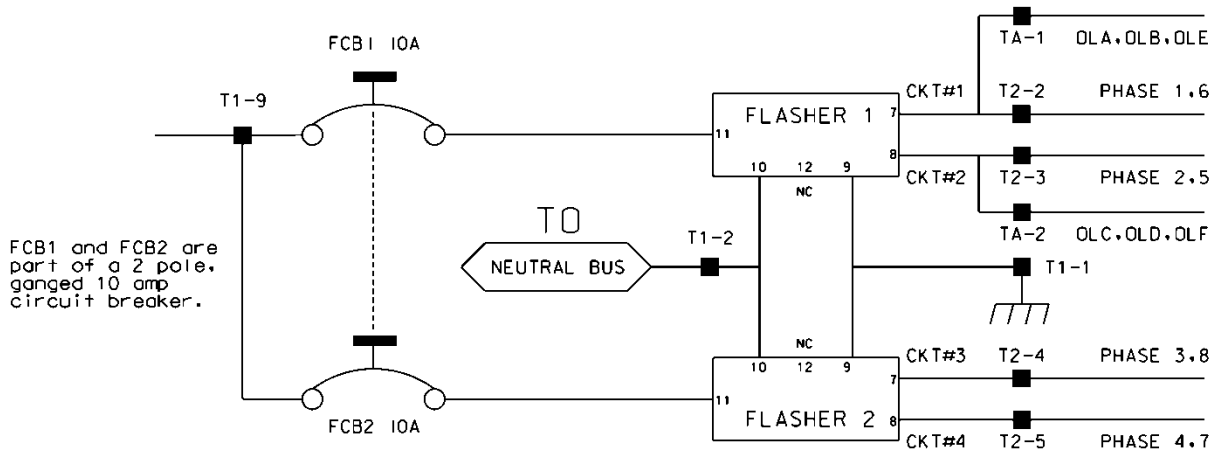

Ensure auxiliary output files are wired as follows:

AUXILIARY OUTPUT FILE	
TERMINAL BLOCK TA ASSIGNMENTS	
POSITION	FUNCTION
1	Flasher Unit #1, Circuit 1/FTR1 (OLA, OLB)/FTR3 (OLE)
2	Flasher Unit #1, Circuit 2/FTR2 (OLC, OLD)/FTR3 (OLF)
3	Flash Transfer Relay Coils
4	AC -
5	Power Circuit 5
6	Power Circuit 5
7	Equipment Ground Bus
8	NC

Provide four spare load resistors mounted in each cabinet. Ensure each load resistor is rated as shown in the table below. Wire one side of each load resistor to AC-. Connect the other side of each resistor to a separate terminal on a four (4) position terminal block. Mount the load resistors and terminal block either inside the back of Output File No. 1 or on the upper area of the Service Panel.

ACCEPTABLE LOAD RESISTOR VALUES	
VALUE (ohms)	WATTAGE
1.5K – 1.9 K	25W (min)
2.0K – 3.0K	10W (min)

Provide Model 200 load switches, Model 204 flashers, Model 242 DC isolators, Model 252 AC isolators, and Model 206L power supply units that conform to CALTRANS' *“Transportation Electrical Equipment Specifications”* dated March 12, 2009 with Erratum 1.

C. Type 170 E Cabinet Physical Requirements:

Do not mold, cast, or scribe the name “City of Los Angeles” on the outside of the cabinet door as specified in LA Specification No. 54-053-08. Do not provide a Communications Terminal Panel as specified in LA Specification No. 54-053-08. Do not provide terminal block TBB on the Service Panel. Do not provide Cabinet Verification Test Program software or associated test jigs as specified in LA Specification No. 54-053-08.

Furnish unpainted, natural, aluminum cabinet shells. Ensure that all non-aluminum hardware on the cabinet is stainless steel or a Department approved non-corrosive alternate.

Ensure the lifting eyes, gasket channels, police panel, and all supports welded to the enclosure and doors are fabricated from 0.125 inch minimum thickness aluminum sheet and meet the same standards as the cabinet and doors.

Provide front and rear doors with latching handles that allow padlocking in the closed position. Furnish 0.75 inch minimum diameter stainless steel handles with a minimum 0.5 inch shank. Place the padlocking attachment at 4.0 inches from the handle shank center to clear the lock and key. Provide an additional 4.0 inches minimum gripping length.

Provide Corbin #2 locks on the front and rear doors. Provide one (1) Corbin #2 and one (1) police master key with each cabinet. Ensure main door locks allow removal of keys in the locked position only.

Provide a surge protection panel with 16 loop surge protection devices and designed to allow sufficient free space for wire connection/disconnection and surge protection device replacement. For model 332 cabinets, provide an additional 20 loop surge protection devices. Provide an additional two AC+ interconnect surge devices to protect one slot and eight DC surge protection devices to protect four slots. Provide no protection devices on slot I14.

For base mounted cabinets, mount surge protection panels on the left side of the cabinet as viewed from the rear. Attach each panel to the cabinet rack assembly using bolts and make it easily removable. Mount the surge protection devices in vertical rows on each panel and connect the devices to one side

of 12 position, double row terminal blocks with #8 screws. For each surge protection panel, terminate all grounds from the surge protection devices on a copper equipment ground bus attached to the surge protection panel. Wire the terminals to the rear of a standard input file using spade lugs for input file protection.

Provide permanent labels that indicate the slot and the pins connected to each terminal that may be viewed from the rear cabinet door. Label and orient terminals so that each pair of inputs is next to each other. Indicate on the labeling the input file (I or J), the slot number (1-14) and the terminal pins of the input slots (either D & E for upper or J & K for lower).

Provide a minimum 14 x 16 inch pull out, hinged top shelf located immediately below controller mounting section of the cabinet. Ensure the shelf is designed to fully expose the table surface outside the controller at a height approximately even with the bottom of the controller. Ensure the shelf has a storage bin interior which is a minimum of 1 inch deep and approximately the same dimensions as the shelf. Provide an access to the storage area by lifting the hinged top of the shelf. Fabricate the shelf and slide from aluminum or stainless steel and ensure the assembly can support the 2070L controller plus 15 pounds of additional weight. Ensure shelf has a locking mechanism to secure it in the fully extended position and does not inhibit the removal of the 2070L controller or removal of cards inside the controller when fully extended. Provide a locking mechanism that is easily released when the shelf is to be returned to its non-use position directly under the controller.

D. Model 2018 Enhanced Conflict Monitor:

Furnish Model 2018 Enhanced Conflict Monitors that provide monitoring of 18 channels. Ensure each channel consists of a green, yellow, and red field signal input. Ensure that the conflict monitor meets or exceeds CALTRANS' Transportation Electrical Equipment Specifications dated March 12, 2009, with Erratum 1 (hereafter referred to as CALTRANS' 2009 TEES) for a model 210 monitor unit and other requirements stated in this specification.

Ensure the conflict monitor is provided with an 18 channel conflict programming card. Pin EE and Pin T of the conflict programming card shall be connected together. Pin 16 of the conflict programming card shall be floating. Ensure that the absence of the conflict programming card will cause the conflict monitor to trigger (enter into fault mode), and remain in the triggered state until the programming card is properly inserted and the conflict monitor is reset.

Provide a conflict monitor that incorporates LED indicators into the front panel to dynamically display the status of the monitor under normal conditions and to provide a comprehensive review of field inputs with monitor status under fault conditions. Ensure that the monitor indicates the channels that were active during a conflict condition and the channels that experienced a failure for all other per channel fault conditions detected. Ensure that these indications and the status of each channel are retained until the Conflict Monitor is reset. Furnish LED indicators for the following:

- AC Power (Green LED indicator)
- VDC Failed (Red LED indicator)
- WDT Error (Red LED indicator)
- Conflict (Red LED indicator)
- Red Fail (Red LED indicator)
- Dual Indication (Red LED indicator)

- Yellow/Clearance Failure (Red LED indicator)
- PCA/PC Ajar (Red LED indicator)
- Monitor Fail/Diagnostic Failure (Red LED indicator)
- 54 Channel Status Indicators (1 Red, 1 Yellow, and 1 Green LED indicator for each of the 18 channels)

Provide a switch to set the Red Fail fault timing. Ensure that when the switch is in the ON position the Red Fail fault timing value is set to 1350 +/- 150 ms (2018 mode). Ensure that when the switch is in the OFF position the Red Fail fault timing value is set to 850 +/- 150 ms (210 mode).

Provide a switch to set the Watchdog fault timing. Ensure that when the switch is in the ON position the Watchdog fault timing value is set to 1.0 +/- 0.1 s (2018 mode). Ensure that when the switch is in the OFF position the Watchdog fault timing value is set to 1.5 +/- 0.1 s (210 mode).

Provide a jumper or switch to set the AC line brown-out levels. Ensure that when the jumper is present or the switch is in the ON position the AC line dropout voltage threshold is 98 +/- 2 Vrms, the AC line restore voltage threshold is 103 +/- 2 Vrms, and the AC line brown-out timing value is set to 400 +/- 50ms (2018 mode). Ensure that when the jumper is not present or the switch is in the OFF position the AC line dropout voltage threshold is 92 +/- 2 Vrms, the AC line restore voltage threshold is 98 +/- 2 Vrms, and the AC line brown-out timing value is set to 80 +/- 17 ms (210 mode).

Provide a jumper or switch that will enable and disable the Watchdog Latch function. Ensure that when the jumper is not present or the switch is in the OFF position the Watchdog Latch function is disabled. In this mode of operation, a Watchdog fault will be reset following a power loss, brownout, or power interruption. Ensure that when the jumper is present or the switch is in the ON position the Watchdog Latch function is enabled. In this mode of operation, a Watchdog fault will be retained until a Reset command is issued.

Provide a jumper that will reverse the active polarity for pin #EE (output relay common). Ensure that when the jumper is not present pin #EE (output relay common) will be considered 'Active' at a voltage greater than 70 Vrms and 'Not Active' at a voltage less than 50 Vrms (Caltrans mode). Ensure that when the jumper is present pin #EE (output relay common) will be considered 'Active' at a voltage less than 50 Vrms and 'Not Active' at a voltage greater than 70 Vrms (Failsafe mode).

In addition to the connectors required by CALTRANS' 2009 TEES, provide the conflict monitor with a red interface connector mounted on the front of the monitor. Ensure the connector is a 20 pin, right angle, center polarized, male connector with latching clip locks and polarizing keys. Ensure the right angle solder tails are designed for a 0.062" thick printed circuit board. Keying of the connector shall be between pins 3 and 5, and between 17 and 19. Ensure the connector has two rows of pins with the odd numbered pins on one row and the even pins on the other row. Ensure the connector pin row spacing is 0.10" and pitch is 0.10". Ensure the mating length of the connector pins is 0.24". Ensure the pins are finished with gold plating 30μ" thick.

U-5710A

TS-20

New Hanover County

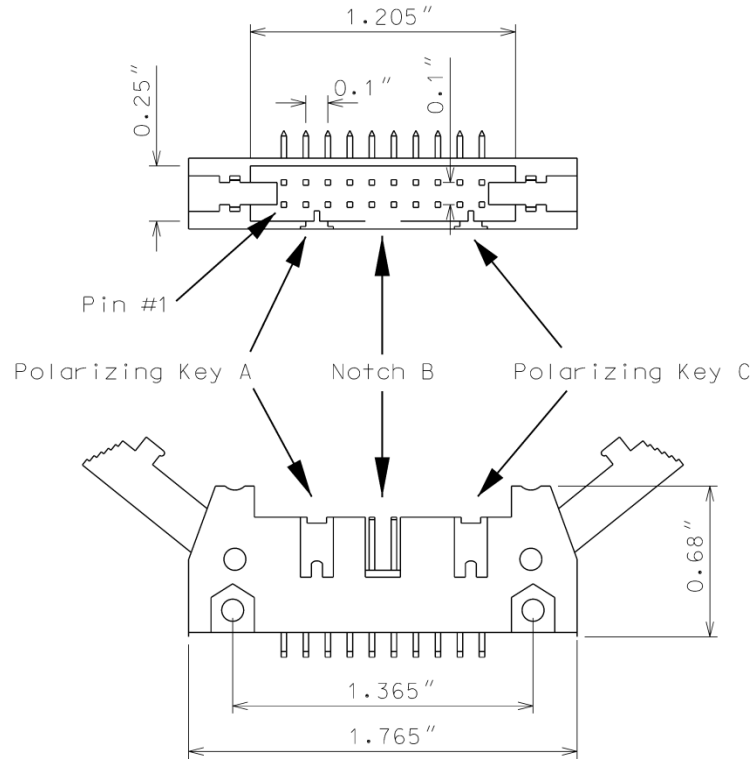

Ensure the red interface connector pins on the monitor have the following functions:

Pin #	Function	Pin #	Function
1	Channel 15 Red	2	Channel 16 Red
3	Channel 14 Red	4	Chassis Ground
5	Channel 13 Red	6	Special Function 2
7	Channel 12 Red	8	Special Function 1
9	Channel 10 Red	10	Channel 11 Red
11	Channel 9 Red	12	Channel 8 Red
13	Channel 7 Red	14	Channel 6 Red
15	Channel 5 Red	16	Channel 4 Red
17	Channel 3 Red	18	Channel 2 Red
19	Channel 1 Red	20	Red Enable

Ensure that removal of the P20 cable connector will cause the conflict monitor to recognize a latching fault condition and place the cabinet into flashing operation.

U-5710A**TS-21****New Hanover County**

Provide Special Function 1 and Special Function 2 inputs to the unit which shall disable only Red Fail Monitoring when either input is sensed active. A Special Function input shall be sensed active when the input voltage exceeds 70 Vrms with a minimum duration of 550 ms. A Special Function input shall be sensed not active when the input voltage is less than 50 Vrms or the duration is less than 250 ms. A Special Function input is undefined by these specifications and may or may not be sensed active when the input voltage is between 50 Vrms and 70 Vrms or the duration is between 250 ms and 550 ms.

Ensure the conflict monitor recognizes field signal inputs for each channel that meet the following requirements:

- consider a Red input greater than 70 Vrms and with a duration of at least 500 ms as an “on” condition;
- consider a Red input less than 50 Vrms or with a duration of less than 200 ms as an “off” condition (no valid signal);
- consider a Red input between 50 Vrms and 70 Vrms or with a duration between 200 ms and 500 ms to be undefined by these specifications;
- consider a Green or Yellow input greater than 25 Vrms and with a duration of at least 500 ms as an “on” condition;
- consider a Green or Yellow input less than 15 Vrms or with a duration of less than 200 ms as an “off” condition; and
- consider a Green or Yellow input between 15 Vrms and 25 Vrms or with a duration between 200 ms and 500 ms to be undefined by these specifications.

Provide a conflict monitor that recognizes the faults specified by CALTRANS’ 2009 TEES and the following additional faults. Ensure the conflict monitor will trigger upon detection of a fault and will remain in the triggered (in fault mode) state until the unit is reset at the front panel or through the external remote reset input for the following failures:

1. **Red Monitoring or Absence of Any Indication (Red Failure):** A condition in which no “on” voltage signal is detected on any of the green, yellow, or red inputs to a given monitor channel. If a signal is not detected on at least one input (R, Y, or G) of a conflict monitor channel for a period greater than 1000 ms when used with a 170 controller and 1500 ms when used with a 2070 controller, ensure monitor will trigger and put the intersection into flash. If the absence of any indication condition lasts less than 700 ms when used with a 170 controller and 1200 ms when used with a 2070 controller, ensure conflict monitor will not trigger. Red fail monitoring shall be enabled on a per channel basis by the use of switches located on the conflict monitor. Have red monitoring occur when all of the following input conditions are in effect:
 - a) Red Enable input to monitor is active (Red Enable voltages are “on” at greater than 70 Vrms, off at less than 50 Vrms, undefined between 50 and 70 Vrms), and
 - b) Neither Special Function 1 nor Special Function 2 inputs are active.
 - c) Pin #EE (output relay common) is not active

2. **Short/Missing Yellow Indication Fault (Clearance Error):** Yellow indication following a green is missing or shorter than 2.7 seconds (with ± 0.1 -second accuracy). If a channel fails to detect an “on” signal at the Yellow input for a minimum of 2.7 seconds (± 0.1 second) following the detection of an “on” signal at a Green input for that channel, ensure that the monitor triggers and generates a clearance/short yellow error fault indication. Short/missing yellow (clearance) monitoring shall be enabled on a per channel basis by the use of switches located on the conflict monitor. This fault shall not occur when the channel is programmed for Yellow Inhibit, when the Red Enable signal is inactive or pin #EE (output relay common) is active.
3. **Dual Indications on the Same Channel:** In this condition, more than one indication (R,Y,G) is detected as “on” at the same time on the same channel. If dual indications are detected for a period greater than 500 ms, ensure that the conflict monitor triggers and displays the proper failure indication (Dual Ind fault). If this condition is detected for less than 200 ms, ensure that the monitor does not trigger. G-Y-R dual indication monitoring shall be enabled on a per channel basis by the use of switches located on the conflict monitor. G-Y dual indication monitoring shall be enabled for all channels by use of a switch located on the conflict monitor. This fault shall not occur when the Red Enable signal is inactive or pin #EE (output relay common) is active.
4. **Configuration Settings Change:** The configuration settings are comprised of (as a minimum) the permissive diode matrix, dual indication switches, yellow disable jumpers, any option switches, any option jumpers, and the Watchdog Enable switch. Ensure the conflict monitor compares the current configuration settings with the previous stored configuration settings on power-up, on reset, and periodically during operation. If any of the configuration settings are changed, ensure that the conflict monitor triggers and causes the program card indicator to flash. Ensure that configuration change faults are only reset by depressing and holding the front panel reset button for a minimum of three seconds. Ensure the external remote reset input does not reset configuration change faults.

Ensure the conflict monitor will trigger and the AC Power indicator will flash at a rate of 2 Hz \pm 20% with a 50% duty cycle when the AC Line voltage falls below the “drop-out” level. Ensure the conflict monitor will resume normal operation when the AC Line voltage returns above the “restore” level. Ensure the AC Power indicator will remain illuminated when the AC voltage returns above the “restore” level. Should an AC Line power interruption occur while the monitor is in the fault mode, then upon restoration of AC Line power, the monitor will remain in the fault mode and the correct fault and channel indicators will be displayed.

Provide a flash interval of at least 6 seconds and at most 10 seconds in duration following a power-up, an AC Line interruption, or a brownout restore. Ensure the conflict monitor will suspend all fault monitoring functions, close the Output relay contacts, and flash the AC indicator at a rate of 4 Hz \pm 20% with a 50% duty cycle during this interval. Ensure the termination of the flash interval after at least 6 seconds if the Watchdog input has made 5 transitions between the True and False state and the AC Line voltage is greater than the “restore” level. If the watchdog input has not made 5 transitions

U-5710A**TS-23****New Hanover County**

between the True and False state within 10 ± 0.5 seconds, the monitor shall enter a WDT error fault condition.

Ensure the conflict monitor will monitor an intersection with a minimum of four approaches using the four-section Flashing Yellow Arrow (FYA) vehicle traffic signal as outlined by the NCHRP 3-54 research project for protected-permissive left turn signal displays. Ensure the conflict monitor will operate in the FYA mode and FYAc (Compact) mode as specified below to monitor each channel pair for the following fault conditions: Conflict, Flash Rate Detection, Red Fail, Dual Indication, and Clearance. Provide a switch to select between the FYA mode and FYAc mode. Provide a switch to select each FYA phase movement for monitoring.

FYA mode

FYA Signal Head	Phase 1	Phase 3	Phase 5	Phase 7
Red Arrow	Channel 9 Red	Channel 10 Red	Channel 11 Red	Channel 12 Red
Yellow Arrow	Channel 9 Yellow	Channel 10 Yellow	Channel 11 Yellow	Channel 12 Yellow
Flashing Yellow Arrow	Channel 9 Green	Channel 10 Green	Channel 11 Green	Channel 12 Green
Green Arrow	Channel 1 Green	Channel 3 Green	Channel 5 Green	Channel 7 Green

FYAc mode

FYA Signal Head	Phase 1	Phase 3	Phase 5	Phase 7
Red Arrow	Channel 1 Red	Channel 3 Red	Channel 5 Red	Channel 7 Red
Yellow Arrow	Channel 1 Yellow	Channel 3 Yellow	Channel 5 Yellow	Channel 7 Yellow
Flashing Yellow Arrow	Channel 1 Green	Channel 3 Green	Channel 5 Green	Channel 7 Green
Green Arrow	Channel 9 Green	Channel 9 Yellow	Channel 10 Green	Channel 10 Yellow

If a FYA channel pair is enabled for FYA operation, the conflict monitor will monitor the FYA logical channel pair for the additional following conditions:

1. **Conflict:** Channel conflicts are detected based on the permissive programming jumpers on the program card. This operation remains unchanged from normal operation except for the solid Yellow arrow (FYA clearance) signal.
2. **Yellow Change Interval Conflict:** During the Yellow change interval of the Permissive Turn channel (flashing Yellow arrow) the conflict monitor shall verify that no conflicting channels to the solid Yellow arrow channel (clearance) are active. These conflicting channels shall be determined by the program card compatibility programming of the Permissive Turn channel (flashing Yellow arrow). During the Yellow change interval of the Protected Turn channel (solid Green arrow) the conflict monitor shall verify that no conflicting channels to the solid Yellow arrow channel (clearance) are active as determined by the program card compatibility programming of the Protected Turn channel (solid Green arrow).
3. **Flash Rate Detection:** The conflict monitor unit shall monitor for the absence of a valid flash rate for the Permissive turn channel (flashing Yellow arrow). If the Permissive turn channel (flashing Yellow arrow) is active for a period greater than 1600 milliseconds, ensure the conflict monitor triggers and puts the intersection into flash. If the Permissive turn channel (flashing Yellow arrow) is active for a period less than 1400 milliseconds, ensure the conflict monitor does not trigger. Ensure the conflict monitor will remain in the triggered (in fault mode) state until the unit is reset at the front panel or through the external remote reset input. Provide a jumper or switch that will enable and disable the Flash Rate Detection function. Ensure that when the jumper is not present or the switch is in the OFF position the Flash Rate Detection function is enabled. Ensure that when the jumper is present or the switch is in the ON position the Flash Rate Detection function is disabled.
4. **Red Monitoring or Absence of Any Indication (Red Failure):** The conflict monitor unit shall detect a red failure if there is an absence of voltage on all four of the inputs of a FYA channel pair (RA, YA, FYA, GA).
5. **Dual Indications on the Same Channel:** The conflict monitor unit shall detect a dual indication if two or more inputs of a FYA channel pair (RA, YA, FYA, GA) are “on” at the same time.
6. **Short/Missing Yellow Indication Fault (Clearance Error):** The conflict monitor unit shall monitor the solid Yellow arrow for a clearance fault when terminating both the Protected Turn channel (solid Green arrow) interval and the Permissive Turn channel (flashing Yellow arrow) interval.

Ensure that the conflict monitor will log at least nine of the most recent events detected by the monitor in non-volatile EEPROM memory (or equivalent). For each event, record at a minimum the time, date, type of event, status of each field signal indication with RMS voltage, and specific channels involved with the event. Ensure the conflict monitor will log the following events: monitor reset, configuration, previous fault, and AC line. Furnish the signal sequence log that shows all channel states (Greens, Yellows, and Reds) and the Red Enable State for a minimum of 2 seconds prior to the current fault trigger point. Ensure the display resolution of the inputs for the signal sequence log is not greater than 50 ms.

For non-Ethernet connected monitors, provide a RS-232C/D compliant port (DB-9 female connector) on the front panel of the conflict monitor in order to provide communications from the conflict monitor to the 170/2070 controller or to a Department-furnished laptop computer. Electrically isolate the port interface electronics from all monitor electronics, excluding Chassis Ground. Ensure

U-5710A**TS-25****New Hanover County**

that the controller can receive all event log information through a controller Asynchronous Communications Interface Adapter (Type 170E) or Async Serial Comm Module (2070). Furnish and connect a serial cable from the conflict monitor's DB-9 connector to Comm Port 1 of the 2070 controller. Ensure conflict monitor communicates with the controller. Provide a Windows based graphic user interface software to communicate directly through the same monitor RS-232C/D compliant port to retrieve and view all event log information to a Department-furnished laptop computer. The RS-232C/D compliant port on the monitor shall allow the monitor to function as a DCE device with pin connections as follows:

Conflict Monitor RS-232C/D (DB-9 Female) Pinout		
Pin Number	Function	I/O
1	DCD	O
2	TX Data	O
3	RX Data	I
4	DTR	I
5	Ground	-
6	DSR	O
7	CTS	I
8	RTS	O
9	NC	-

U-5710A

TS-26

New Hanover County

MONITOR BOARD EDGE CONNECTOR

Pin #	Function (Back Side)	Pin #	Function (Component Side)
1	Channel 2 Green	A	Channel 2 Yellow
2	Channel 13 Green	B	Channel 6 Green
3	Channel 6 Yellow	C	Channel 15 Green
4	Channel 4 Green	D	Channel 4 Yellow
5	Channel 14 Green	E	Channel 8 Green
6	Channel 8 Yellow	F	Channel 16 Green
7	Channel 5 Green	H	Channel 5 Yellow
8	Channel 13 Yellow	J	Channel 1 Green
9	Channel 1 Yellow	K	Channel 15 Yellow
10	Channel 7 Green	L	Channel 7 Yellow
11	Channel 14 Yellow	M	Channel 3 Green
12	Channel 3 Yellow	N	Channel 16 Yellow
13	Channel 9 Green	P	Channel 17 Yellow
14	Channel 17 Green	R	Channel 10 Green
15	Channel 11 Yellow	S	Channel 11 Green
16	Channel 9 Yellow	T	Channel 18 Yellow
17	Channel 18 Green	U	Channel 10 Yellow
--		--	
18	Channel 12 Yellow	V	Channel 12 Green
19	Channel 17 Red	W	Channel 18 Red
20	Chassis Ground	X	Not Assigned
21	AC-	Y	DC Common
22	Watchdog Timer	Z	External Test Reset
23	+24VDC	AA	+24VDC
24	Tied to Pin 25	BB	Stop Time (Output)
25	Tied to Pin 24	CC	Not Assigned
26	Not Assigned	DD	Not Assigned
27	Relay Output, Side #3, N.O.	EE	Relay Output, Side #2, Common
28	Relay Output, Side #1, N.C.	FF	AC+

-- Slotted for keying between Pins 17/U and 18/V

U-5710A

TS-27

New Hanover County

CONFLICT PROGRAM CARD PIN ASSIGNMENTS

Pin #	Function (Back Side)	Pin #	Function (Component Side)
1	Channel 2 Green	A	Channel 1 Green
2	Channel 3 Green	B	Channel 2 Green
3	Channel 4 Green	C	Channel 3 Green
4	Channel 5 Green	D	Channel 4 Green
5	Channel 6 Green	E	Channel 5 Green
6	Channel 7 Green	F	Channel 6 Green
7	Channel 8 Green	H	Channel 7 Green
8	Channel 9 Green	J	Channel 8 Green
9	Channel 10 Green	K	Channel 9 Green
10	Channel 11 Green	L	Channel 10 Green
11	Channel 12 Green	M	Channel 11 Green
12	Channel 13 Green	N	Channel 12 Green
13	Channel 14 Green	P	Channel 13 Green
14	Channel 15 Green	R	Channel 14 Green
15	Channel 16 Green	S	Channel 15 Green
16	N/C	T	PC AJAR
17	Channel 1 Yellow	U	Channel 9 Yellow
18	Channel 2 Yellow	V	Channel 10 Yellow
19	Channel 3 Yellow	W	Channel 11 Yellow
20	Channel 4 Yellow	X	Channel 12 Yellow
21	Channel 5 Yellow	Y	Channel 13 Yellow
22	Channel 6 Yellow	Z	Channel 14 Yellow
23	Channel 7 Yellow	AA	Channel 15 Yellow
24	Channel 8 Yellow	BB	Channel 16 Yellow
--		--	
25	Channel 17 Green	CC	Channel 17 Yellow
26	Channel 18 Green	DD	Channel 18 Yellow
27	Channel 16 Green	EE	PC AJAR (Program Card)
28	Yellow Inhibit Common	FF	Channel 17 Green

-- Slotted for keying between Pins 24/BB and 25/CC

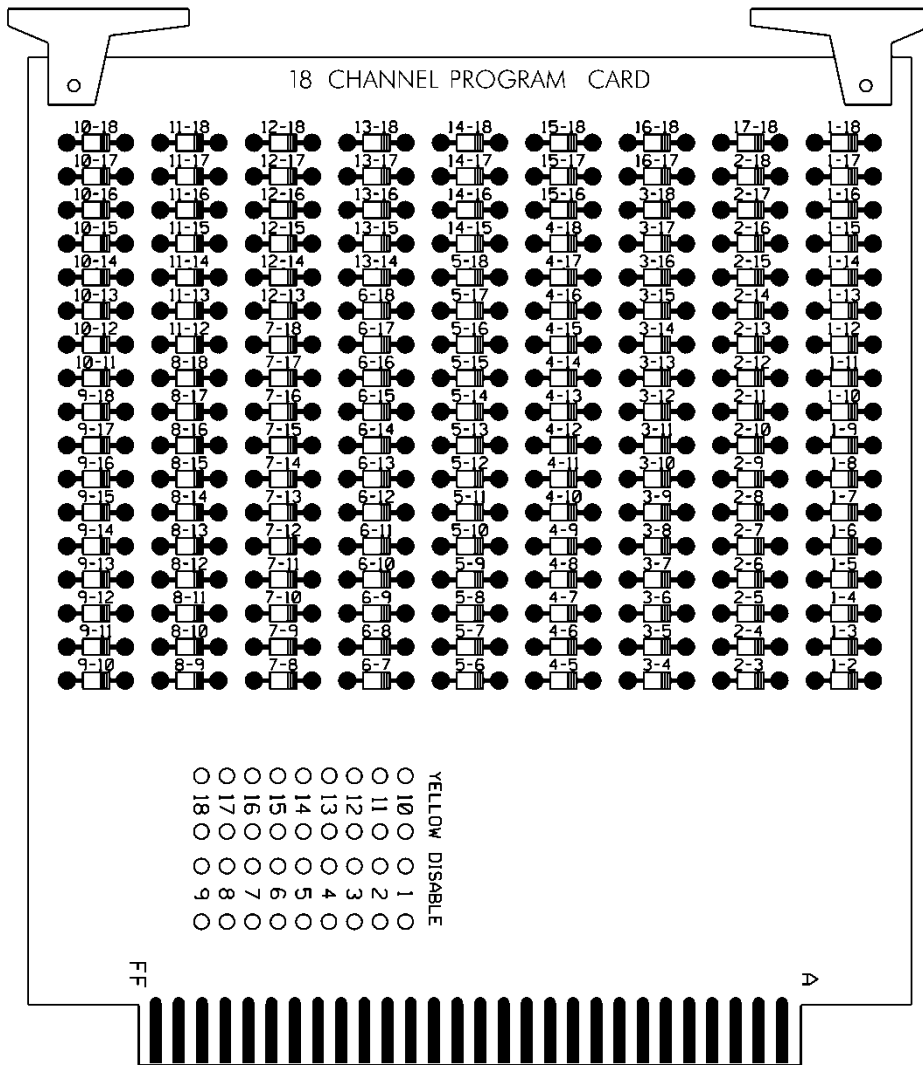

E. Preemption and Sign Control Box

Provide preemption and sign control box to operate in a Model 332 cabinet. Provide hardware to mount the box to the cage of the cabinet to ensure the front side is facing the opposite side of the cabinet. Furnish the material of the box from a durable finished metallic or thermoplastic case. Ensure the size of the box is not greater than 7(l) x 5(w) x 5(d) inches. Ensure that no modification is necessary to mount the box on the cabinet cage.

Provide the following components in the preemption and sign control box: relays, fuses, terminal blocks, MOVs, resistor, RC network, lamp, and push button switch.

Provide UL Listed or Recognized relay K1 as a DPDT enclosed relay (120 VAC, 60 Hz coil) with an 8-pin octal-style plug and associated octal base. Provide contact material made of AgCdO with a 10 amp, 240 VAC rating. Ensure the relay has a specified pickup voltage of 102 VAC.

Provide relay SSR1 as a Triac SPST normally open solid state relay that is rated for 120 VAC input and zero-crossing (resistive load) 25 amp @ 120 VAC output. Ensure the relay turns on at 90

U-5710A**TS-29****New Hanover County**

Vrms within 10 ms and turns off at 10 Vrms within 40 ms. Ensure the relay has physical characteristics as shown in the wiring detail in Figure 1. Provide 4 terminal screws with saddle clamps.

Provide fuses F1 and F2 as a UL Listed ¼" x 1-1/4" glass tube rated at 250 volts with a 10kA interrupting rating. Ensure F1 non-delay (fast-acting) and F2 slow-blow (time-delay) fuses have a maximum opening times of 60 minutes and 120 seconds for currents of 135 and 200 percent of the ampere rating, respectively. Ensure F2 slow-blow (time-delay) fuses have a minimum opening times of 12 seconds at 200 percent of the ampere rating. Provide fuse holders that are UL Recognized panel-mounted holders rated 250V, 15 ampere minimum with bayonet-type knobs which accept ¼" x 1-1/4" glass tube fuses.

Provide terminal blocks that are rated for 300V and are made of electrical grade thermoplastic or thermosetting plastic. Ensure each terminal block is of closed back design and has recessed-screw terminals with molded barriers between terminals. Ensure each terminal block is labeled with a block designation. Ensure each terminal is labeled with the function and a number.

Provide 3/4-inch diameter radial lead UL-recognized metal oxide varistors (MOVs) that have electrical performance as outlined below.

PROPERTIES OF MOV SURGE PROTECTOR	
Maximum Continuous Applied Voltage at 185° F	150 VAC (RMS) 200 VDC
Maximum Peak 8x20µs Current at 185° F	6500 A
Maximum Energy Rating at 185° F	80 J
Voltage Range 1 mA DC Test at 77° F	212-268 V
Max. Clamping Voltage 8x20µs, 100A at 77° F	395 V
Typical Capacitance (1 MHz) at 77° F	1600 pF

Provide resistor R1 as a 2K ohm, 12 watt, wirewound resistor with tinned terminals and attaching leads. Ensure the resistor is spaced apart from surrounding wires.

Provide a LED or incandescent lamp that has a voltage rating of 120 VAC with a minimum life rating at 50,000 hours.

Wire the preemption and sign control box as shown in Figure 1.

RAILROAD PREEMPTION WIRING DETAIL

(wire as shown below)

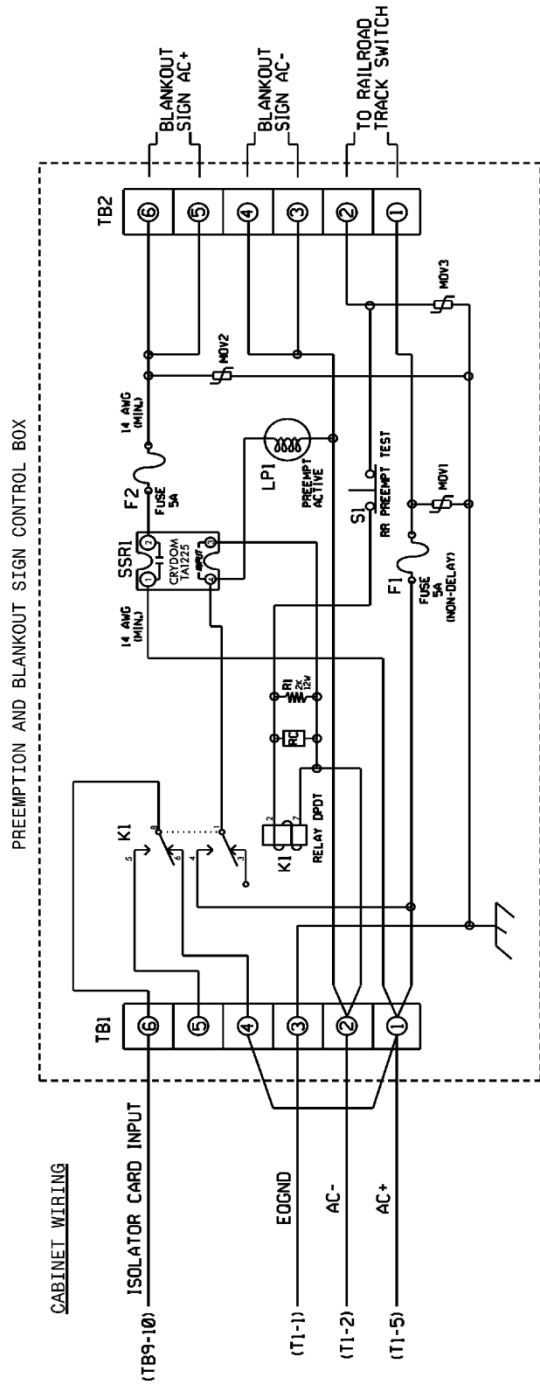

NOTES

1. RELAY K1 IS SHOWN IN THE ENERGIZED (PREEMPT NO1 ACTIVE) NORMAL OPERATION STATE.
2. AC ISOLATOR CARD SHALL ACTIVATE PREEMPTION UPON REMOVAL OF AC+ FROM INPUT (AS SHOWN ABOVE). THIS IS ACCOMPLISHED BY SETTING TYPE 252 AC ISOLATOR CARD TO INVERTED OPERATION.

FRONT VIEW

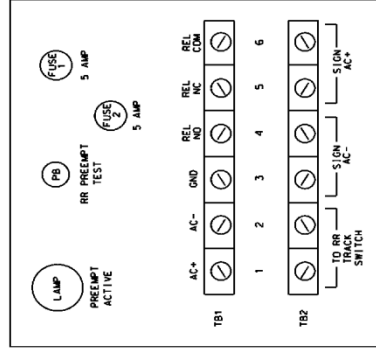

Figure 1

3.3. MATERIALS – TYPE 170 DETECTOR SENSOR UNITS

Furnish detector sensor units that comply with Chapter 5 Section 1, “General Requirements,” and Chapter 5 Section 2, “Model 222 & 224 Loop Detector Sensor Unit Requirements,” of the CALTRANS “Transportation Electrical Equipment Specifications” dated March 12, 2009 with Erratum 1.

3.4. MATERIALS – TYPE 2070E CONTROLLERS

Furnish model 2070E controller units that conform to CALTRANS *Transportation Electrical Equipment Specifications* (TEES) (dated March 12, 2009, plus Errata 1 dated January 21, 2010 and Errata 2 dated December 5, 2014) except as required herein.

The Department will provide software at the beginning of the burning-in period. Contractor shall give 5 working days notice before needing software. Program software provided by the Department.

Provide model 2070E controllers with OS-9 release 1.3.1 or later with kernel edition #380 or later operating software and device drivers, composed of the unit chassis and at a minimum the following modules and assemblies:

- MODEL 2070-1E, CPU Module, Single Board, with 8Mb Datakey (blue in color)
- MODEL 2070-2E+, Field I/O Module (FI/O)
 - Note: Configure the Field I/O Module to disable both the External WDT Shunt/Toggle Switch and SP3 (SP3 active indicator is “off”)
- MODEL 2070-3B, Front Panel Module (FP), Display B (8x40)
- MODEL 2070-4A, Power Supply Module, 10 AMP
- MODEL 2070-7A, Async Serial Com Module (9-pin RS-232)

4. MICROWAVE VEHICLE DETECTION SYSTEM - MULTIPLE DETECTION ZONES

4.1. DESCRIPTION

Design, furnish and install a microwave vehicle detection system with the manufacturer recommended cables and hardware in accordance to the plans and specifications. Ensure the detection system provides multiple detection zones.

4.2. MATERIALS

Provide design drawings showing design details and microwave sensor locations for review and acceptance before installation. Provide mounting height and location requirements for microwave sensor units on the design based on a site survey. Design microwave vehicle detection system with all necessary hardware. Indicate all necessary poles, spans, mast arms, luminaire arms, cables, microwave sensor mounting assemblies and hardware to achieve the required detection zones where Department owned poles are not adequate to locate the microwave sensor units. Do not design for the installation of poles in medians.

Obtain the Engineer’s approval before furnishing microwave vehicle detection system. The contractor is responsible for the final design of microwave vehicle detection system. Review and acceptance of the designs by the Department does not relieve the contractor from the responsibility to provide fully functional systems and to ensure that the required detection zones can be provided. With the exception of contractor-furnished poles, mast arms, and luminaire arms, furnish material, equipment, and hardware under this section that is pre-approved on the ITS and Signals QPL.

Submit and obtain Engineer's approval of shop drawings for any poles, mast arms, and luminaire arms provided by the contractor prior to ordering from manufacturer.

Provide a detector for either side-fire or forward-fire configuration. Ensure the detector will detect vehicles in sunny, cloudy, rainy, snowy, and foggy weather conditions. Ensure the detector can operate from the voltage supplied by a NEMA TS-1/TS-2 or Type 332 or 336 traffic signal cabinet. Ensure the detector can provide detection calls to the traffic signal controller within a NEMA TS-1/TS-2 or Type 332 or 336 cabinet. Ensure the detection system provides a constant call in the event of a component failure or loss of power. Ensure the detector has an operating temperature range of -30 to 165 degrees F and operates within the frequency range of 10 to 25 GHz. Ensure the detector is provided with a water-tight housing offering NEMA 4X protection and operates properly in up to 95% relative humidity, non-condensing.

Provide each detector unit to allow the placement of at least 8 detection zones with a minimum of 8 detection channel outputs. When the microwave vehicle detection system requires an integrated card rack interface(s), provide only enough interface cards to implement the vehicle detection shown on the signal plans. Provide a means acceptable to the Engineer to configure traffic lanes and detection zones. Provide each channel output with a programmable means to delay the output call upon activation of a detection zone that is adjustable in one second increments (maximum) over the range of 0 to 25 seconds. Provide each channel output with a programmable means to extend the output call that is adjustable in one second increments (maximum) over the range of 0 to 25 seconds. Ensure both delay and extend timing can be set for the same channel output.

For advance detection system, ensure the detector senses vehicles in motion at a range of 50 to 400 feet from the detector unit for forward-fire configuration and a range of 50 to 200 feet from the detector unit for side-fire configuration with an accuracy of 95% for both configurations. Ensure the advance detection system provides each channel output call of at least 100 ms in duration.

For stop bar presence detection system, ensure the detector outputs a constant call while a vehicle is in the detection zone and removes the call after all vehicles exit the detection zone. Ensure the presence detector unit can cover a detection zone as shown on the plans and has an effective range of 10 to 120 feet from the detector unit.

For units without an integrated card rack interface, provide Form C output relay contacts rated a minimum of 3A, 24VDC.

If a laptop is used to adjust detector settings, ensure that software is licensed for use by the Department and by any other agency responsible for maintaining or operating the microwave detection system. Provide the Department with a license to duplicate and distribute the software as necessary for design and maintenance support.

After initial detector configuration and installation, ensure routine adjustments or calibration are not needed to maintain acceptable performance.

4.3. CONSTRUCTION METHODS

Install the microwave vehicle detection system in accordance with the manufacturer's recommendations.

Monitor and maintain each detector unit during construction to ensure microwave vehicle detection system is functioning properly and aimed for the detection zone shown in the plans. Refer to Subarticle 1700-3 (D) Maintenance and Repair of Materials of the *Standard Specifications* for failure to maintain the microwave detection system.

4.4. MEASUREMENT AND PAYMENT

Actual number of microwave vehicle detection systems – multiple zones furnished, installed, and accepted.

No measurement will be made of cables or hardware, as these will be considered incidental to furnishing and installing microwave vehicle detection systems.

Payment will be made under:

Microwave Vehicle Detection System – Multiple Zones Each

5. TRAFFIC SIGNAL SUPPORTS

5.1. METAL TRAFFIC SIGNAL SUPPORTS – ALL POLES

A. General:

Furnish and install metal strain poles and metal poles with mast arms, grounding systems, and all necessary hardware. The work covered by this special provision includes requirements for the design, fabrication, and installation of both standard and custom/site specifically designed metal traffic signal supports and associated foundations.

Provide metal traffic signal support systems that contain no guy assemblies, struts, or stay braces. Provide designs of completed assemblies with hardware that equals or exceeds AASHTO *Standard Specifications for Structural Supports for Highway Signs, Luminaires and Traffic Signals* 6th Edition, 2013 (hereafter called 6th Edition AASHTO), including the latest interim specifications. Provide assemblies with a round or near-round (18 sides or more) cross-section, or a multi sided cross section with no less than six sides. The sides may be straight, convex, or concave.

Pole heights shown on signal plans are estimated from available data for bid purposes. Prior to furnishing metal signal poles, use field measurements and adjusted cross-sections to determine whether pole heights are sufficient to obtain required clearances. If pole heights are not sufficient, the Contractor should immediately notify the Engineer of the required revised pole heights.

Ensure that metal signal poles permit cables to be installed inside poles and any required mast arms. For holes in the poles and arms used to accommodate cables, provide full-circumference grommets. Arm flange plate wire access holes should be deburred, non grommets, and oversized to fit around the 2” diameter grommets shaft flange plate wire access hole.

After fabrication, have steel poles, required mast arms, and all parts used in the assembly hot-dip galvanized per section 1076. Design structural assemblies with weep holes large enough and properly located to drain molten zinc during the galvanization process. Provide hot-dip galvanizing on structures that meets or exceeds ASTM Standard A-123. Provide galvanizing on hardware that meets or exceeds ASTM Standard A-153. Ensure that threaded material is brushed and retapped as necessary after galvanizing. Perform repair of damaged galvanizing that complies with the following:

Repair of GalvanizingArticle 1076-7

Standard Drawings for Metal Poles are available that supplement these project special provisions. These drawings are located on the Department’s website:

<https://connect.ncdot.gov/resources/safety/pages/ITS-Design-Resources.aspx>

U-5710A

TS-34

New Hanover County

Comply with article 1098-1B of the *2018 STANDARD SPECIFICATIONS FOR ROADS & STRUCTURES*, hereinafter referred to as the *Standard Specifications* for submittal requirements. Furnish shop drawings for approval. Provide the copies of detailed shop drawings for each type of structure as summarized below. Ensure that shop drawings include material specifications for each component and identify welds by type and size on the detail drawing only, not in table format. **Do not release structures for fabrication until shop drawings have been approved by NCDOT.** Provide an itemized bill of materials for all structural components and associated connecting hardware on the drawings.

Comply with article 1098-1A of the *Standard Specifications* for Qualified Products List (QPL) submittals. All shop drawings must include project location description, signal inventory number(s) and a project number or work order number on the drawings.

Summary of information required for metal pole review submittal:

Item	Hardcopy Submittal	Electronic Submittal	Comments / Special Instructions
Sealed, Approved Signal Plan/Loading Diagram	1	1	All structure design information needs to reflect the latest approved signal plans
Custom Pole Shop Drawings	4 sets	1 set	Show NCDOT inventory number(s), contractor's name and relevant revision number in the title block. All drawings must have a unique <u>drawing</u> number for each project and identified for multiple pages.
Standard Pole Shop Drawings (from the QPL)	4 sets	1 set	Submit drawings on 11" x 17" format media. Show NCDOT inventory number(s), contractor's name and relevant revision number in the title block. All drawings must have a <u>unique drawing</u> number for each project and identified for multiple pages.
Structure Calculations	1 set	1 set	Not required for Standard QPL Poles
Standard Pole Foundation Drawings	1 set	1 set	Submit drawings on 11" x 17" format media. Submit a completed Standard Foundation Selection form for each pole using foundation table on Metal Pole Drawing M-8.
Custom Foundation Drawings	4 sets	1 set	Submit drawings on 11" x 17" format media. Show NCDOT inventory number(s), contractor's name and relevant revision number in the title block. All drawings must have a <u>unique drawing</u> number for each project and identified for multiple pages. If QPL Poles are used, include the corresponding QPL pole shop drawings with this submittal.

U-5710A

TS-35

New Hanover County

Foundation Calculations	1	1	Submit copies of LPILE input, output and pile tip deflection graph per Section 11.4 of this specification for each foundation. Not required for Standard QPL Poles
Soil Boring Logs and Report	1	1	Report should include a location plan and a soil classification report including soil capacity, water level, hammer efficiency, soil bearing pressure, soil density, etc. for each pole.

NOTE – All shop drawings and custom foundation design drawings must be sealed by a Professional Engineer licensed in the state of North Carolina. All geotechnical information must be sealed by either a Professional Engineer or geologist licensed in the state of North Carolina. Include a title block and revision block on the shop drawings and foundation drawings showing the NCDOT inventory number.

Shop drawings and foundation drawings may be submitted together or separately for approval. However, shop drawings must be approved before foundations can be reviewed. Foundation designs will be returned without review if the associated shop drawing has not been approved. Boring reports should include the following: Engineer’s summary, boring location maps, soil classification per AASHTO Classification System, hammer efficiency, and Metal Pole Standard Foundation Selection Form. Incomplete submittals will be returned without review. The Reviewer has the right to request additional analysis and copies of the calculations to expedite the approval process.

B. Materials:

Fabricate metal pole and arm shaft from coil or plate steel to meet the requirements of ASTM A 595 Grade A tubes. For structural steel shapes, plates and bars use A572 Gr 50 min or ASTM A709 Gr 50 min. Provide pole and arm shafts that are round in cross section or multisided tubular shapes and have a uniform linear taper of 0.14 in/ft. Construct shafts from one piece of single ply plate or coil so there are no circumferential weld splices. Galvanize in accordance with AASHTO M 111 or an approved equivalent.

Use the submerged arc process or other NCDOT previously approved process suitable for pole shaft and arms to continuously weld pole shafts and arm shafts along their entire length. The longitudinal seam weld will be finished flush to the outside contour of the base metal. Ensure shafts have no circumferential welds except at the lower end joining the shaft to the pole base and arm base. Use full penetration groove welds with backing ring for all tube-to-transverse-plate connections in accordance with 6th Edition AASHTO. Provide welding that conforms to Article 1072-18 of the *Standard Specifications*, except that no field welding on any part of the pole will be permitted unless approved by a qualified engineer.

Refer to Metal Pole Standard Drawing Sheets M2 through M5 for fabrication details. Fabricate anchor bases and mast arm connecting plates from plate steel meeting, as a minimum, the requirements of ASTM A572 Gr 50, AASHTO M270 Gr 50, ASTM A709 Gr50, or an approved equivalent. Conform to the applicable bolt pattern and orientation as shown on Metal Pole Standard Drawing Sheet M2.

Ensure all hardware is galvanized steel or stainless steel. The Contractor is responsible for ensuring that the designer/fabricator specifies connecting hardware and/or materials that do not create a dissimilar metal corrosive reaction.

Provide a minimum of four (4) 1-1/2" diameter high strength bolts for connection between arm plate and pole plate. Increase number of bolts to six (6) 1-1/2" diameter high strength bolts when arm lengths are greater than 50'-0" long.

Unless otherwise required by the design, ensure each anchor rod is 2" diameter and 60" length. Provide 10" minimum thread projection at the top of the rod, and 8" minimum at the bottom of the rod. Use anchor rod assembly and drilled pier foundation materials that meet the *Foundations and Anchor Rod Assemblies for Metal Poles* provision.

For each structural bolt and other steel hardware, hot dip galvanizing shall conform to the requirements of AASHTO M 232 (ASTM A 153). Ensure end caps for poles or mast arms are constructed of cast aluminum conforming to Aluminum Alloy 356.0F.

Provide a circular anchor bolt lock plate that will be secured to the anchor bolts at the embedded end with 2 washers and 2 nuts. Provide a base plate template that matches the bolt circle diameter of the anchor bolt lock plate. Construct plates and templates from 1/4" minimum thick steel with a minimum width of 4". Galvanizing is not required for both plates.

Provide 4 heavy hex nuts and 4 flat washers for each anchor bolt. For nuts, use AASHTO M291 grade 2H, DH, or DH3 or equivalent material. For flat washers, use AASHTO M293 or equivalent material.

C. Construction Methods:

Erect signal support poles only after concrete has attained a minimum allowable compressive strength of 3000 psi. Install anchor rod assemblies in accordance with the *Foundations and Anchor Rod Assemblies for Metal Poles* provision.

For further construction methods, see construction methods for Metal Strain Pole, or Metal Pole with Mast Arm.

Connect poles to grounding electrodes and bond them to the electrical service grounding electrodes.

For holes in the poles used to accommodate cables, install grommets before wiring pole or arm. Do not cut or split grommets.

Attach the terminal compartment cover to the pole by a sturdy chain or cable. Ensure the chain or cable is long enough to permit the cover to hang clear of the compartment opening when the cover is removed, and is strong enough to prevent vandalism. Ensure the chain or cable will not interfere with service to the cables in the pole base.

Attach cap to pole with a sturdy chain or cable. Ensure the chain or cable is long enough to permit the cap to hang clear of the opening when the cap is removed.

Perform repair of damaged galvanizing that complies with the *Standard Specifications*, Article 1076-7 "Repair of Galvanizing."

Install galvanized wire mesh around the perimeter of the base plate to cover the gap between the base plate and top of foundation for debris and pest control.

Install a 1/4" thick plate for concrete foundation tag to include: concrete grade, depth, diameter, and reinforcement sizes of the installed foundation.

5.2. METAL POLE UPRIGHTS (VERTICAL MEMBERS)

A. Materials:

- Provide tapered tubular shafts and fabricated of steel conforming to ASTM A-595 Grade A or an approved equivalent.
- Hot-dip galvanize poles in accordance with AASHTO M 111 or an approved equivalent.
- Have shafts that are continuously welded for the entire length by the submerged arc process, and with exposed welds ground or rolled smooth and flush with the base metal. Provide welding that conforms to Article 1072-18 of the *Standard Specification* except that no field welding on any part of the pole will be permitted.
- Have Shafts with no circumferential welds except at the lower end joining the shaft to the base.
- Have anchor bases for steel poles fabricated from plate steel meeting as a minimum the requirements of ASTM A572 Gr 50, AASHTO M270 Gr 50, ASTM A709 Gr 50, or an approved equivalent.

Provide a grounding lug(s) in the approximate vicinity of the messenger cable clamp for bonding and grounding messenger cable. Lugs must accept #4 or #6 AWG wire to bond messenger cables to the pole in order to provide an effective ground fault circuit path. Refer to Metal Pole Standard Drawing Sheet M6 for construction details.

Have poles permanently stamped above the hand holes with the identification tag details as shown on Metal Pole Standard Drawing Sheet M2.

Provide liquid tight flexible metal conduit (Type LFMC), liquid tight flexible nonmetallic conduit (Type LFNC), high density polyethylene conduit (Type HDPE), or approved equivalent to isolate conductors feeding luminaires.

Fabricate poles from a single piece of steel or aluminum with single line seam weld with no transverse butt welds. Fabrication of two ply pole shafts is unacceptable with the exception of fluted shafts. Provide tapers for all shafts that begin at base and that have diameters which decrease uniformly at the rate of not more than 0.14 inch per foot (11.7 millimeters per meter) of length.

Provide four anchor nuts and four washers for each anchor bolt. Ensure that anchor bolts have required diameters, lengths, and positions, and will develop strengths comparable to their respective poles.

Provide a terminal compartment with cover and screws in each pole that encompasses the hand hole and contains a 12-terminal barrier type terminal block. Provide two terminal screws with a removable shorting bar between them for each termination. Furnish terminal compartment covers attached to the pole by a sturdy chain or cable approved by the Engineer. Ensure that the chain or cable is long enough to permit the cover to hang clear of the compartment opening when the cover is removed, and is strong enough to prevent vandals from being able to disconnect the cover from the pole. Ensure that the chain or cable will not interfere with service to the cables in the pole base.

Install grounding lugs that will accept #4 or #6 AWG wire to electrically bond messenger cables to the pole. Refer to Metal Pole Standard Drawing Sheet M6 for construction details.

For each pole, provide a 1/2 inch minimum thread diameter, coarse thread stud and nut for grounding which will accommodate #6 AWG ground wire. Ensure that the lug is electrically bonded to the pole and is conveniently located inside the pole at the hand hole.

Provide a removable pole cap with stainless steel attachment screws for the top of each pole. Ensure that the cap is cast aluminum conforming to Aluminum Association Alloy 356.0F. Furnish cap attached to the pole with a sturdy chain or cable approved by the Engineer. Ensure that the chain or cable is long enough to permit the cap to hang clear of the pole-top opening when the cap is removed.

When required by the plans, furnish couplings 42 inches above the bottom of the base for mounting of pedestrian pushbuttons. Provide mounting points consisting of 1-1/2 inch internally threaded half-couplings that comply with the NEC and that are mounted within the poles. Ensure that couplings are essentially flush with the outside surfaces of the poles and are installed before any required galvanizing. Provide a threaded plug in each mounting point. Ensure that the surface of the plug is essentially flush with the outer end of the mounting point when installed and has a recessed hole to accommodate a standard wrench.

1. STRAIN POLE SHAFTS

Provide 2 messenger cable (span wire) clamps and associated hardware for attachment of messenger cable. Ensure that diameter of the clamp is appropriate to its location on the pole and is appropriately designed to be adjustable from 1'-6" below the top, down to 6'-6" below the top of the pole. Do not attach more than one support cable to a messenger cable clamp.

Provide a minimum of three (3) 2 inch (50 mm) holes equipped with an associated coupling and weatherhead on the messenger cable load side of the pole to accommodate passage of signal cables from inside the pole. Provide galvanized threaded plugs for all unused couplings at pole entrance points. Refer to Metal Pole Standard Drawing Sheet M3 for fabrication details.

Ensure that allowable pole deflection does not exceed that allowed per 6th Edition AASHTO. Ensure maximum deflection at the top of the pole does not exceed 2.5 percent of the pole height.

2. MAST ARM POLE SHAFTS

Ensure that allowable pole deflection does not exceed that allowed per 6th Edition AASHTO. Ensure that maximum angular rotation of the top of the mast arm pole does not exceed 1 degree 40 minutes (1°40').

B. Construction Methods:

Install metal poles, hardware, and fittings as shown on the manufacturer's installation drawings. Install metal poles so that when the pole is fully loaded it is within 1 degree 40 minutes (1°40') of vertical. Install poles with the manufacturer's recommended "rake." Use threaded leveling nuts to establish rake if required.

5.3. MAST ARMS

Provide pole plates and associated gussets and fittings for attachment of required mast arms. As part of each mast arm attachment, provide a cable passage hole in the pole to allow passage of signal cables from the pole to the arm.

Ensure that allowable mast arm deflection does not exceed that allowed per 6th Edition AASHTO. Also when arm is fully loaded, tip of the arm shall not go below the arm attachment point with the pole for all load conditions per 6th Edition AASHTO.

Furnish all arm plates and necessary attachment hardware, including bolts and brackets.

Provide two extra bolts for each arm.

Provide grommet holes on the arms to accommodate cables for the signals.

Provide arms with weatherproof connections for attaching to the shaft of the pole.

Provide hardware that is galvanized steel, stainless steel, or corrosive-resistant aluminum.

Provide a removable end cap with stainless steel attachment screws for the end of each mast arm. Ensure that the cap is cast aluminum conforming to Aluminum Association Alloy 356.0F. Furnish cap attached to the arm with a sturdy chain or cable approved by the Engineer. Ensure that the chain or cable is long enough to permit the cap to hang clear of the arm end opening when the cap is removed.

Comply with the following for Steel Luminaire Arms:

- In addition to tapered tube, luminaire arms may be standard weight black steel pipe conforming to ASTM A 53-90a, Type E or Type S, Grade B or an approved equivalent.
- Conform to the welding requirements of the steel poles.
- After all fabricating, cutting, punching, and welding are completed, luminaire arms should be hot-dipped galvanized inside and outside.
- In accordance with the National Electrical Code (NEC) Article 230.2(E), provide identification of the electrical source provider for the luminaire feeder circuit with contact information on a permanent label located in the pole hand hole in the vicinity of the feeder circuit raceway.

A. Materials:

After all fabricating, cutting, punching, and welding are completed, hot-dip galvanize the structure in accordance with the AASHTO M 111 or an approved equivalent.

B. Construction Methods:

Install horizontal-type arms with sufficient manufactured rise to keep arm from deflecting below the arm attachment height.

Attach cap to the mast arm with a sturdy chain or cable. Ensure that the chain or cable is long enough to permit the cap to hang clear of the arm opening when the cap is removed.

For mast arm poles, use full penetration welds with back-up ring at the pole base and at the arm base connection.

5.4. DRILLED PIER FOUNDATIONS FOR METAL TRAFFIC SIGNAL POLES

Analysis procedures and formulas shall be based on AASHTO 6th Edition, latest ACI code and the *Drilled Shafts: Construction Procedures and Design Methods* FHWA-NHI-10-016 manual. Design methods based on engineering publications or research papers needs to have prior approval from NCDOT. The Department reserves the right to accept or disapprove any method used for the analysis.

Use a Factor of Safety of 1.33 for torsion and 2.0 for bending for the foundation design.

Foundation design for lateral load shall not exceed 1” lateral deflection at top of foundation.

For lateral analysis, use LPILE Plus V6.0 or later. Inputs, results and corresponding graphs are to be submitted with the design calculations.

Skin Friction is to be calculated using the α -method for cohesive soils and the β -method for cohesion-less soils (**Broms method will not be accepted**). Detailed descriptions of the “ α ” and “ β ” methods can be found in *FHWA-NHI-10-016*.

Omit first 2.5ft for cohesive soils when calculating skin friction.

When hammer efficiency is not provided, assume a value of 0.70.

Design all custom foundations to carry the maximum capacity of each metal pole. For standard case strain poles only, if a custom foundation is designed, use the actual shear, axial and moment reactions from the Standard Foundation Selection Table shown on Standard Drawing No. M8.

When poor soil conditions are encountered which could create an excessively large foundation design, consideration may be given to allowing an exemption to the maximum capacity design. The contractor must gain approval from the engineer before reducing a foundation’s capacity. On projects where poor soil is known to be present, it is advisable that the contractor consider getting foundations approved before releasing poles for fabrication.

Have the contractor notify the engineer if the proposed foundation is to be installed on a slope other than 8H: 1V or flatter.

A. Description:

Furnish and install foundations for NCDOT metal poles with all necessary hardware in accordance with the plans and specifications.

Metal Pole Standards have been developed and implemented by NCDOT for use at signalized intersections in North Carolina. If the plans call for a standard pole, then a standard foundation may be selected from the plans. However, the Contractor is not required to use a standard foundation. If the Contractor chooses to design a non-standard site-specific foundation for a standard pole or if the plans call for a non-standard site-specific pole, design the foundation to conform to the applicable provisions in the NCDOT Metal Pole Standard Drawings and Section B7 (Non-Standard Foundation Design) below. If non-standard site specific foundations are designed for standard QPL approved strain poles, the foundation designer must use the design moment specified by load case on Metal Pole Standard Drawing Sheet M8. Failure to conform to this requirement will be grounds for rejection of the design.

If the Contractor chooses to design a non-standard foundation for a standard pole and the soil test results indicate a standard foundation is feasible for the site, the Contractor will be paid the cost of the standard foundation (drilled pier and wing wall, if applicable). Any additional costs associated with a non-standard site-specific foundation including additional materials, labor and equipment will be considered incidental to the cost of the standard foundation. All costs for the non-standard foundation design will also be considered incidental to the cost of the standard foundation.

B. Soil Test and Foundation Determination:

1. General:

Drilled piers are reinforced concrete sections, cast-in-place against in situ, undisturbed material. Drilled piers are of straight shaft type and vertical.

Some standard drilled piers for supporting poles with mast arms may require wing walls to resist torsional rotation. Based upon this provision and the results of the required soil test, a drilled pier length and wing wall requirement may be determined and constructed in accordance with the plans.

For non-standard site-specific poles, the contractor-selected pole fabricator will determine if the addition of wing walls is necessary for the supporting foundations.

2. Soil Test:

Perform a soil test at each proposed metal pole location. Complete all required fill placement and excavation at each signal pole location to finished grade before drilling each boring. Soil tests performed that are not in compliance with this requirement may be rejected and will not be paid. Drill one boring to a depth of 26 feet within a 25 foot radius of each proposed foundation.

Perform standard penetration tests (SPT) in accordance with ASTM D 1586 at depths of 1, 2.5, 5, 7.5, 10, 15, 20 and 26 feet. Discontinue the boring if one of the following occurs:

- A total of 100 blows have been applied in any 2 consecutive 6-in. intervals.
- A total of 50 blows have been applied with < 3-in. penetration.

Describe each intersection as the “Intersection of (Route or SR #), (Street Name) and (Route or SR #), (Street Name), _____ County, Signal Inventory No. _____”. Label borings with “B- N, S, E, W, NE, NW, SE or SW” corresponding to the quadrant location within the intersection. Pole numbers should be made available to the Drill Contractor. Include pole numbers in the boring label if they are available. If they are not available, ensure the boring labels can be cross-referenced to corresponding pole numbers. For each boring, submit a legible (hand written or typed) boring log signed and sealed by a licensed Geologist or Professional Engineer registered in North Carolina. Include on each boring the SPT blow counts and N-values at each depth, depth of the boring, hammer efficiency, depth of water table and a general description of the soil types encountered using the AASHTO Classification System.

3. Standard Foundation Determination:

Use the following method for determining the Design N-value:

$$N_{AVG} = \frac{(N@1' + N@2.5' + \dots + N@Deepest \text{ Boring Depth})}{\text{Total Number of N-values}}$$

$$Y = (N@1')^2 + (N@2.5')^2 + \dots + (N@Deepest \text{ Boring Depth})^2$$

$$Z = (N@1' + N@2.5' + \dots + N@Deepest \text{ Boring Depth})$$

$$N_{STD \text{ DEV}} = \left[\frac{(\text{Total Number of N-values} \times Y) - Z^2}{(\text{Total Number of N-values}) \times (\text{Total Number of N-values} - 1)} \right]^{0.5}$$

Design N-value equals lesser of the following two conditions:

$$N_{AVG} - (N_{STD \text{ DEV}} \times 0.45)$$

Or

$$\text{Average of First Four N-Values} = \frac{(N@1' + N@2.5' + N@5' + N@7.5')}{4}$$

Note: If less than 4 N-values are obtained because of criteria listed in Section 2 above, use average of N-values collected for second condition. Do not include the N-value at the deepest boring depth for above calculations if the boring is discontinued at or before the required boring depth because of criteria listed in Section 2 above. Use N-value of zero for weight of hammer or weight of rod. If N-value is greater than 50, reduce N-value to 50 for calculations.

If standard NCDOT strain poles are shown on the plans and the Contractor chooses to use standard foundations, determine a drilled pier length, “L,” for each signal pole from the Standard Foundations Chart (sheet M 8) based on the Design N-value and the predominant soil type. For each standard pole location, submit a completed “Metal Pole Standard Foundation Selection Form” signed by the Contractor’s representative. Signature on form is for verification purposes only. Include the Design N-value calculation and resulting drilled pier length, “L,” on each form.

If non-standard site-specific poles are shown on the plans, submit completed boring logs collected in accordance with Section 2 (Soil Test) above along with pole loading diagrams from the plans to the contractor-selected pole fabricator to assist in the pole and foundation design.

If one of the following occurs, the Standard Foundations Chart shown on the plans may not be used and a non-standard foundation may be required. In such case, contact the Engineer.

- The Design N-value is less than 4.
- The drilled pier length, “L”, determined from the Standard Foundations Chart, is greater than the depth of the corresponding boring.

In the case where a standard foundation cannot be used, the Department will be responsible for the additional cost of the non-standard foundation.

Foundation designs are based on level ground around the traffic signal pole. If the slope around the edge of the drilled pier is steeper than 8:1 (H:V) or the proposed foundation will be less than 10 feet from the top of an embankment slope, the Contractor is responsible for providing slope information to the foundation designer and to the Engineer so it can be considered in the design.

The “Metal Pole Standard Foundation Selection Form” may be found at:

<http://www.ncdot.gov/doh/preconstruct/highway/geotech/formdet/misc/MetalPole.pdf>

If assistance is needed, contact the Engineer.

4. Non-Standard Foundation Design:

Design non-standard foundations based upon site-specific soil test information collected in accordance with Section 2 (Soil Test) above. Design drilled piers for side resistance only in accordance with Section 4.6 of the *AASHTO Standard Specifications for Highway Bridges*. Use the computer software LPILE version-6.0 or later manufactured by Ensoft, Inc. to analyze drilled piers. Use the computer software gINT V8i or later manufactured by Bentley Systems, Inc. with the current NCDOT gINT library and data template to produce SPT boring logs. Provide a drilled pier foundation for each pole with a length and diameter that result in a horizontal lateral movement of less than 1 inch

at the top of the pier and a horizontal rotational movement of less than 1 inch at the edge of the pier. Contact the Engineer for pole loading diagrams for standard poles to be used for non-standard foundation designs. Submit any non-standard foundation designs including drawings, calculations, and soil boring logs to the Engineer for review and approval before construction.

C. Drilled Pier Construction:

Construct drilled pier foundations in accordance with the *Foundations and Anchor Rod Assemblies for Metal Poles* provision.

5.5. CUSTOM DESIGN OF TRAFFIC SIGNAL SUPPORTS

A. General:

Design traffic signal supports with foundations consisting of metal strain poles or metal poles with mast arms.

The lengths of the metal signal poles shown on the plans are estimated from available data for bid purposes. Determine the actual length of each pole from field measurements and adjusted cross-sections. Furnish the revised pole heights to the Engineer. Use all other dimensional requirements shown on the plans.

Ensure each pole includes an identification tag with information and location positions as defined on Metal Pole Standard Drawing Sheets M2, M3 and M4. All pole shaft tags must include the NCDOT Inventory number followed by the pole number shown on the traffic signal or ITS (non-signalized locations) plan.

Design all traffic signal support structures using the following 6th Edition AASHTO specifications:

- Design for a 50 year service life as recommended by Table 3.8.3-2.
- Use the wind pressure map developed from 3-second gust speeds, as provided in Article 3.8.
- Ensure signal support structures include natural wind gust loading and truck-induced gust loading in the fatigue design, as provided for in Articles 11.7.1.2 and 11.7.1.3, respectively. Designs need not consider periodic galloping forces.
- Assume the natural wind gust speed in North Carolina is 11.2 mph. For natural wind fatigue stress calculations, utilize a drag coefficient (C_d) computed for 11.2 mph wind velocity and not the basic wind speed velocity.
- Design for Category II fatigue, as provided for in Article 11.6, unless otherwise specified.
- Calculate all stresses using applicable equations from Section 5. The Maximum allowable stress ratios for all signal support designs are 0.9.
- Conform to article 10.4.2 and 11.8 for all deflection requirements.

Ensure that the design permits cables to be installed inside poles and mast arms.

Unless otherwise specified by special loading criteria, the computed surface area for ice load on signal heads is:

- 3-section, 12-inch, Surface area: 26.0 ft² (17.0 ft² without back plate)
- 4-section, 12-inch, Surface area: 32.0 ft² (21.0 ft² without back plate)
- 5-section, 12-inch, Surface area: 42.0 ft² (29.0 ft² without back plate)

The ice loading for signal heads defined above includes the additional surface area that back plates will induce. Special loading criteria may be specified in instances where back plates will not be installed on signal heads. Refer to the Loading Schedule on each Metal Pole Loading Diagram for revised signal head surface areas. The pole designer should revise ice loads accordingly in this instance. Careful examination of the plans when this is specified is important as this may impact sizing of the metal support structure and foundation design which could affect proposed bid quotes. All maximum stress ratios of 0.9 still apply.

Assume the combined minimum weight of a messenger cable bundle (including messenger cable, signal cable and detector lead-in cables) is 1.3 lbs/ft. Assume the combined minimum diameter of this cable bundle is 1.3 inches.

Ensure that designs provide a removable pole cap with stainless steel attachment screws for each pole top and mast arm end.

B. Metal Poles:

Submit design drawings for approval including pre-approved QPL pole drawings. Show all the necessary details and calculations for the metal poles including the foundation and connections. Include NCDOT inventory number on design drawings. Include as part of the design calculations the ASTM specification numbers for the materials to be used. Provide the types and sizes of welds on the design drawings. Include a Bill of Materials on design drawings. Ensure design drawings and calculations are signed, dated, and sealed by the responsible professional engineer licensed in the state of North Carolina. Immediately bring to the attention of the Engineer any structural deficiency that becomes apparent in any assembly or member of any assembly as a result of the design requirements imposed by these specifications, the plans, or the typical drawings. Said Professional Engineer is wholly responsible for the design of all poles and arms. Review and acceptance of these designs by the Department does not relieve the said Professional Engineer of his responsibility. **Do not fabricate the assemblies until receipt of the Department's approval of the design drawings.**

For mast arm poles, provide designs with provisions for pole plates and associated gussets and fittings for mast arm attachment. As part of each mast arm attachment, provide a grommeted 2" diameter hole on the shaft side of the connection to allow passage of the signal cables from the pole to the arm.

Where ice is present, assume wind loads as shown in Figure 3.9.4.2-3 of the 6th Edition AASHTO Specification for Group III loading.

For each strain pole, provide two messenger cable clamps and associated hardware to attach the messenger support cable. Ensure that the diameter of the clamps is appropriately designed to be adjustable from 1'-6" inches below the top, down to 6'-6" below the top of the pole. Do not attach more than one messenger support cable to a messenger cable clamp.

Provide a grounding lug(s) in the approximate vicinity of the messenger cable clamp for bonding and grounding messenger cable. Lugs must accept #4 or #6 AWG wire to bond messenger cables to the pole in order to provide an effective ground fault circuit path. Refer to Metal Pole Standard Drawing Sheet M6 for construction details.

Design tapers for all pole shafts that begin at the base with diameters that decrease uniformly at the rate of 0.14 inch per foot of length.

Design a base plate on each pole. The minimum base plate thickness for all poles is determined by the following criteria:

Case 1 Circular or rectangular solid base plate with the upright pole welded to the top surface of base plate with full penetration butt weld, and where no stiffeners are provided. A base plate with a small center hole, which is less than 1/3 of the upright diameter, and located concentrically with the upright pole, may be considered as a solid base plate.

The magnitude of bending moment in the base plate, induced by the anchoring force of each anchor bolt is $M = (P \times D_1) / 2$, where

M = bending moment at the critical section of the base plate induced by one anchor bolt

P = anchoring force of each anchor bolt

D_1 = horizontal distance between the anchor bolt center and the outer face of the upright, or the difference between the bolt circle radius and the outside radius of the upright

Locate the critical section at the face of the anchor bolt and perpendicular to the bolt circle radius. The overlapped part of two adjacent critical sections is considered ineffective.

Case 2 Circular or rectangular base plate with the upright pole socketed into and attached to the base plate with two lines of fillet weld, and where no stiffeners are provided, or any base plate with a center hole that is larger in diameter than 1/3 of the upright diameter.

The magnitude of bending moment induced by the anchoring force of each anchor bolt is $M = P \times D_2$,

where P = anchoring force of each anchor bolt

D_2 = horizontal distance between the face of the upright and the face of the anchor bolt nut

Locate the critical section at the face of the anchor bolt top nut and perpendicular to the radius of the bolt circle. The overlapped part of two adjacent critical sections is considered ineffective.

If the base plate thickness calculated for Case 2 is less than Case 1, use the thickness calculated for Case 1.

The following additional owner requirements apply concerning pole base plates.

- Ensure that whichever case governs as defined above, the anchor bolt diameter is set to match the base plate thickness. If the minimum diameter required for the anchor bolt exceeds the thickness required for the base plate, set the base plate thickness equal to the required bolt diameter.
- For dual mast arm supports, or for single mast arm supports 50' or greater, use a minimum 8 bolt orientation with 2" diameter anchor bolts, and a 2" thick base plate.
- For all metal poles with mast arms, use a full penetration groove weld with a backing ring to connect the pole upright component to the base. Refer to Metal Pole Standard Drawing Sheet M4.

Ensure that designs have anchor bolt holes with a diameter 1/4 inch larger than the anchor bolt diameters in the base plate.

Ensure that the anchor bolts have the required diameters, lengths, and positions, and will develop strengths comparable to their respective poles.

Provide designs with a 6 x 12-inch hand hole with a reinforcing frame for each pole.

Provide designs with a terminal compartment with cover and screws in each pole that encompasses the hand hole and contains provisions for a 12-terminal barrier type terminal block.

For each pole, provide designs with provisions for a 1/2 inch minimum thread diameter, coarse thread stud and nut for grounding which will accommodate a #6 AWG ground wire. Ensure the lug is electrically bonded to the pole and is conveniently located inside the pole at the hand hole.

When required, design couplings on the pole for mounting pedestrian pushbuttons at a height of 42 inches above the bottom of the base. Provide mounting points consisting of 1-1/2 inch internally threaded half-couplings that comply with the NEC that are mounted within the poles. Ensure the couplings are essentially flush with the outside surfaces of the poles and are installed before any required galvanizing. Provide a threaded plug for each half coupling. Ensure that the surface of the plug is essentially flush with the outer end of the mounting point when installed and has a recessed hole to accommodate a standard wrench.

C. Mast Arms:

Design all arm plates and necessary attachment hardware, including bolts and brackets as required by the plans.

Design for grommets holes on the arms to accommodate the cables for the signals if specified.

Design arms with weatherproof connections for attaching to the shaft of the pole.

Always use a full penetration groove weld with a backing ring to connect the mast arm to the pole. Refer to Metal Pole Standard Drawing Sheet M5.

Capacity of tapped flange plate must be sufficient to develop the full capacity of the connecting bolts. In all cases the flange plate of both arm and shaft must be at least as thick as the arm connecting bolts are in diameter.

5.6. METAL SIGNAL POLE REMOVALS

A. Description:

Remove existing metal signal poles including mast arms and return to Division 3 Traffic Services. Remove and dispose of existing foundations, associated anchor bolts, electrical wires and connections.

B. Construction Methods:

1. Foundations:

Remove and promptly dispose of the metal signal pole foundations including reinforcing steel, electrical wires, and anchor bolts to a minimum depth of two feet below the finished ground elevation. At the Contractor's option, remove the complete foundation.

2. Metal Poles:

Remove the metal signal poles and mast arms and promptly transport the metal signal poles and mast arms from the project to Division 3 Traffic Services. Use methods to remove the metal signal poles and attached traffic signal equipment that will not result in damage to other portions of the project or facility. Repair damages that are a result of the Contractor's actions at no additional cost to the Department.

Backfill and compact disturbed areas to match the finished ground elevation. Seed unpaved areas.

Use methods to remove the foundations that will not result in damage to other portions of the project or facility. Repair damages that are a result of the Contractor's actions at no cost to the Department.

5.7. POLE NUMBERING SYSTEM

A. New Poles

Attach an identification tag to each pole shaft and mast arm section as shown on Metal Pole Standard Drawing Sheet M2 “Typical Fabrication Details Common To All Metal Poles”.

5.8. MEASUREMENT AND PAYMENT

Actual number of metal strain signal poles (without regard to height or load capacity) furnished, installed and accepted.

Actual number of metal poles with single mast arms furnished, installed, and accepted.

Actual number of soil tests with SPT borings drilled furnished and accepted.

Actual volume of concrete poured in cubic yards of drilled pier foundation furnished, installed and accepted.

Actual number of designs for metal strain poles furnished and accepted.

Actual number of designs for mast arms with metal poles furnished and accepted.

Actual number of metal signal pole foundations removed and disposed.

Actual number of metal signal poles removed and returned to Division 3 Traffic Services.

No measurement will be made for foundation designs prepared with metal pole designs, as these will be considered incidental to designing signal support structures.

Payment will be made under:

Metal Strain Signal Pole	Each
Metal Pole with Single Mast Arm	Each
Soil Test	Each
Drilled Pier Foundation.....	Cubic Yard
Metal Strain Pole Design	Each
Mast Arm with Metal Pole Design	Each
Metal Pole Foundation Removal	Each
Metal Pole Removal.....	Each

6. PROTECTIVE COATING FOR METAL POLES

6.1. Description

Protective coating for metal poles is a supplemental durable color coating that is applied to galvanized steel and aluminum traffic signal structures installed in locations where maintaining an aesthetic appearance is important. Powder Coating is the preferred supplemental protective coating process for coating galvanized steel and aluminum structures. However, for the purposes of this special provision, an Acrylic Primer and top coat paint system is included as an acceptable alternative when protective color coating is required.

Provide protective coating over galvanization for all steel poles including all necessary hardware in accordance with the plans and specifications. Any aluminum components do not need to be galvanized before application of protective coating.

6.2. Materials

With the exception of aluminum components, furnish all metal poles with galvanic protection along with a tough and durable application of protective coating. Aluminum components shall have a durable powder coating application. Galvanization is not required for aluminum components.

Furnish pole caps that have a low gloss powder finish applied over a hot-dipped galvanized surface. Comply with the applicable provisions of Section 442-10 and 442-12 of the *Standard Specifications*.

Ensure the selected color for protective coating has been verified and approved by the Engineer prior to fabrication.

6.3. Coating Shop Approval

Approve the coating shop facility prior to the application of any coating process. Submit all requests, procedures and documents electronically to:

- Mr. Brian Hunter, P.E., Chemical Testing Engineer
- bhunter@ncdot.gov

A) Submit a quality control procedure that the company has established to ensure a quality and durable coating. The quality control procedure shall contain at a minimum the following:

- Qualified / Certified personnel to manage the QC Program and to conduct Quality Control tests
- Qualified / certified coaters
- Source and type of powder
- How the powder will be stored
- Powder application facility (heated or unheated)
- Surface pre-treatment
- Surface preparation including profile
- Application methods
- Curing conditions (conventional or infrared)
- Curing Temperature
- Adhesion & Holiday Detection
- Repair Procedure
- Storage and protection of coated items
- Shipping and handling (packing, protection, and wrapping)

B) Submit a powder certification from the manufacturer

C) Submit the following to the Chemical Testing Engineer a minimum of four weeks prior to coating application.

1. Two test panels of ASTM A36 steel, ¼ or greater in thickness measuring 8 inches by 11 inches using the proposed color of the final coat; a powder coated over galvanized test panel and a powder coated over un-galvanized test panel.

U-5710A

TS-49

New Hanover County

2. In addition, provide two (2) samples of the same or comparable material and thickness as production pieces. Ensure production piece replicas do not exceed twelve inches (12") in length and width nor 50 pounds in weight.
3. Submit all test panels with inspection reports and records according to *Standard Specifications*, Section 442, Section 1072, Section 1076, and Section 1080.
4. Acceptance of the panels is determined by meeting the requirements of ASTM D-4541 of 800 psi for both galvanized and un-galvanized and production piece test panels.
5. Send all panels to :
 - Materials and Tests Unit
 - 1801 Blue Ridge Road
 - Raleigh, NC 27607
 - Attn: Chemical Testing Engineer

6.4. POWDER COATING

A. Galvanizing

Galvanize steel products in accordance with Section 1076 of the *Standard Specifications*. Ensure the fabricator or designated representative(s) that is supplying the components to be galvanized communicates with the galvanizer to indicate that the galvanized pieces will be powder coated to avoid water or chromate quenching.

B. Surface Preparation

Comply with manufacturer's recommended surface coating specifications, Steel Structure Painting Council (SSPC) specifications and applicable articles of Section 442 (Painting Steel Structures) of the *Standard Specifications*. Ensure that surface preparations and treatments are performed and meet the requirements of the above referenced specifications.

Some pole components, specifically steel plates $\frac{3}{4}$ inches or more in thickness, may need blast cleaning prior to structure assembly to remove impurities and non-metallic foreign materials. Mechanically remove all weld flux after structure is assembled

Degrease and prepare steel structure for zinc coating after assembly using full immersion baths and pickling processes in heat controlled caustic and acid solutions. Rinse and clean structure to remove caustic or acid solutions by immersion in a circulating fresh water bath. Immerse structure in a heat controlled concentrated zinc ammonium chloride flux solution and air dry as a final prep before hot-dip galvanization.

Ensure that the surface preparation is no less than specified by the powder manufacturer's recommendations. Prepare all components to be coated in accordance with SSPC SP-2 (Hand Tool Cleaning) and/or SSPC SP-3 (Power Tool Cleaning). Remove all drainage spikes, high spots, protrusions or other surface defects using hand or power tools. Do not remove the galvanization below the limits set forth in AASHTO M111.

Remove grease, oils, moisture, scale, rust or any other foreign matter prior to powder coating to ensure ideal adhesion and coating performance. Prepare and coat the galvanized surface as soon as possible after the galvanization process.

U-5710A

TS-50

New Hanover County

C. Powder Coating Application and Curing

Prepare galvanized finish for powder coating by brush blasting in accordance with SSPC-SP7. Ensure all threaded components of the structure are protected from damage during blasting process.

Use thermosetting powder resin that meets 5A or 5B classifications of ASTM D3359. Apply powder coating electrostatically. Follow manufacturer's recommended preheating requirements. Ensure the top coat finish is applied uniformly to all surfaces with a dry film thickness of between 3.0 to 5.0 mils. Cure the top coat by heating the structure to manufacturer recommended temperatures at the duration required to ensure complete and uniform bond.

D. Quality Control

Ensure the applicator provides all test reports and documentation and inspects all coated material as outlined in the *Standard Specifications*, Section 442, Section 1072, Section 1076, and Section 1080. Ensure the quality control inspection is kept separate from the production functions.

E. Storage, Shipping, and Handling

Store all powder coated material inside or as directed by the Engineer.

Protect the product from incurring damage during all shipping, handling, and storing activities. Do not store the product directly on the ground or in areas where water may pool; the Engineer determines the effectiveness of all storage, shipping and handling methods.

F. Repair of Powder Coated Material

Repair all damage to the coating by the original method of application as outlined in the coating facility's repair procedure. Ensure all repair areas meet the original requirements for adhesion as stated in this Project Special Provision.

Photograph, document, and report all damages upon delivery to the project site prior to unloading. Provide documented damage notifications to the Engineer or to their authorized representative so the application firm can be notified. The Engineer has the authority to accept or reject the material as outlined in the *Standard Specifications*.

Submit to the Engineer a repair procedure for damaged coatings which occur during storage, transporting, handling and or installation. Utilize a liquid paint approved by the Department, compatible with the powder applied product. Ensure all repair areas demonstrate an adhesion rating of 400 psi in accordance with ASTM D-4541. Obtain Engineer's acceptance of the final finish.

6.5.ACRYLIC PRIMER AND TOP COAT PAINT SYSTEM 4 (MODIFIED)**A. Description**

Follow NCDOT procedures for Powder Coating over Galvanizing. Provide an Acrylic Primer and top coat when a substitute for powder coating is necessary.

U-5710A**TS-51****New Hanover County**

Provide supplemental coating for all mast arms with metal signal poles and all necessary hardware for the signalized intersection in accordance with NCDOT Standard specifications – sections 442 and 1080, as contained herein, and as shown on the plans.

Ensure all painting work for new structures, except field touch-up and bolt painting is performed in the shop.

B. Surface Preparation

Ensure all surface preparation is not less than that specified by the paint manufacturer's recommendations.

Ensure all components to be coated are prepared in accordance with SSPC SP2 (Hand Tool Cleaning and or SSPC SP-3 (Power Tool Cleaning). Remove all drainage spikes, high spots, protrusions or other surface defects using hand or power tools. Do not remove the galvanization below the limits set forth in AASHTO M111.

Perform abrasive sweep blasting in accordance with ASTM D6386. Refer to this section for a description of the abrasive blast material to be used. Use a material and technique capable of stripping action to remove corrosion products and to provide a rough surface profile while leaving base zinc layers intact.

Blow down all blasted surfaces with clean compressed air to provide a clean, dry surface.

Ensure all surfaces are free of visible zinc oxides or zinc hydroxides.

C. Materials

Use an approved/qualified waterborne paint meeting the requirements of NCDOT Standard specification section 1080. Do not apply paint until each batch has been tested by the Department. Provide color as specified in the contract documents.

Ensure all paint used on this contract is produced by the same manufacturer.

D. Painting

Apply paint in accordance with the requirements of Section 1080 and Section 442 of the 2010 *Standard Specifications* using System 4 as modified herein.

U-5710A

TS-52

New Hanover County

**System 4 (Modified)
Acrylic Primer and Top Coats**

Coat	Material	Mils Dry/Wet Film Thickness	Mils Dry/Wet Film Thickness
		Minimum	Maximum
Primer	1080-12 White	3.0 DFT	5.0 DFT
Stripe	1080-12 Brown	4.0 WFT	7.0 WFT
Topcoat	1080-12 Brown	2.0 DFT	4.0 DFT
Total		5.0 DFT	9.0 DFT

Shop paint all galvanized surfaces within 8 hours after surface preparation with the exception of field touch-up and bolt painting.

Mask off and do not paint all data plates and faying surfaces prior to application.

Spray apply all coatings except for the stripe coat. Brush apply the stripe coat to all plate edges, welds, bolt holes and bolts prior to applying the finish coat.

E. Curing

Store all material in a heated shop for a period no less than 24 hours once top coat has been applied. Continue storing material until requirements of ASTM D-1640 have been met.

F. Inspection

Provide inspection records showing the initial average thickness of the hot dipped galvanizing as well as the final average DFT measurement.

Ensure all material is of a uniform appearance free of runs, drips, and sags.

G. Handling

Do not handle, ship, or erect coated members until paint is thoroughly dry.

Protect all shipping and handling either from the coating facility to project site and or storage site to area(s) to construction location from incurring damage to product. Wood blocks and nylon slings are recommended for securing, loading, hoisting or storing members.

H. Repair of Damaged Coating

Repair damage occurring to the galvanized portion of the coating during shipment or installation in accordance with Articles 1076-6 and 1080-9 of the *Standard Specifications*. Repair damage occurring to the painted portion of the coating during shipment or installation by applying 4.0-7.0 wet mils of topcoat with a brush or roller and feather or taper this to be level with the surrounding areas.

6.6. MEASUREMENT AND PAYMENT

Actual number of strain poles with protective coating applied furnished, installed, and accepted.

Actual number of single mast arm poles with protective coating applied furnished, installed, and accepted.

Actual number of signal pedestals with protective coating applied furnished, installed, and accepted.

Payment will be made under:

Protective Coating for Strain Pole (Black)	Each
Protective Coating for Single Mast Arm Pole (Black)	Each
Protective Coating for Signal Pedestal (Black)	Each

7. BACK PULL FIBER OPTIC CABLE

7.1. DESCRIPTION

Back pull and store or back pull and reinstall existing communications cable.

7.1. CONSTRUCTION

During project construction where instructed to back pull existing aerial sections of fiber optic communications cable, de-lash the cable from the messenger cable and back pull the cable to a point where it can be stored or re-routed as shown on the plans. If instructed, remove and discard the existing messenger cable and pole mounting hardware once the cable is safely out of harm’s way.

During project construction where instructed to back pull existing underground sections of fiber optic communications cable, back pull the cable to a point where it can be stored or re-routed as shown on the plans. If instructed, remove abandoned junction boxes and backfill with a suitable material to match the existing grade. Leave abandoned conduits in place unless otherwise noted.

Where instructed, re-pull the fiber optic cable back along messenger cable or through conduit systems.

7.2. MEASUREMENT AND PAYMENT

Back Pull Fiber Optic Cable will be paid for as the actual linear feet of fiber optic cable back pulled and either stored or back pulled and rerouted. Payment is for the actual linear feet of cable back pulled.

No payment will be made for removing messenger cable and pole mounting hardware or removing junction boxes and back filling to match the surrounding grade as these items of work will be considered incidental to back pulling the fiber optic cable.

Payment will be made under:

Back Pull Fiber Optic Cable	Linear Feet
-----------------------------------	-------------

8. DROP CABLE ASSEMBLY

8.1. DESCRIPTION

Furnish and install a single mode fiber-optic (SMFO) drop cable assemblies.

8.2. MATERIALS

Furnish factory-preassembled, factory-preterminated drop assemblies with integral, pre-attached interconnect centers/patch panels designed to mount inside equipment cabinets. Furnish drop cable assemblies to provide communications links between splice enclosures and fiber-optic transceivers and match drop cable assemblies installed on prior projects.

Provide an assembly that is factory-assembled with the designated drop cable length. The assembly may be rail mounted or rack mounted. If the assembly is rack mounted it shall occupy only one rack unit.

Construct the drop cable assembly using single-mode, fiber-optic cable containing a minimum of six fibers. Furnish patch panel with a minimum of six ST connectors.

Furnish low bend radius single mode cable described above. A low bend radius cable is defined as a fiber-optic cable whose manufacturer-specified minimum bend radius does not exceed 5 inches when loaded and 4 inches when installed. Provide outdoor-rated, non-armored, riser rated cable. Provide UV-rated cable.

Use single-mode fiber-optic cable that does not exceed attenuation of 0.30 dB/km at 1550 nm and 0.40 dB/km at 1310 nm. Ensure attenuation loss for complete drop cable assembly does not exceed a mean value of 1.5 dB.

Provide metal connector housing, ceramic ferrules and coupler inserts. Provide a connector attenuation of .20 dB and a reflectance of < -40 dB SPC/<-55 dB UPC. Use heat-cured epoxy material.

Provide length markings in sequential feet and within one percent of actual cable length. Ensure character height of markings is approximately 0.10".

Furnish factory-assembled SMFO jumpers that are a minimum of 3 feet in length with LC/PC connectors on one end and ST/PC connectors at the other end for connecting Ethernet edge switches to the drop cable assembly's patch panel. Ensure SMFO jumpers meet the operating characteristics of the SMFO cable with which they are to be coupled.

8.3. CONSTRUCTION METHODS

Determine the length of drop cable needed, including slack, to reach from termination point to termination point.

Splice the free end of the drop cable assembly into the fiber-optic trunk cable in a splice enclosure external to the cabinet.

For existing riser locations, remove the existing weatherhead. Install fiber-optic drop cable and then install heat shrink tubing retrofit kit.

At aerial splice enclosures, install the aerial splice enclosure and corresponding cable storage rack at least 50 feet apart and store at least 50 feet of slack cable for each cable entering and exiting the splice enclosure between the splice enclosure and corresponding cable storage rack. Coil and store any drop cable in excess of what is needed for overhead storage in the base of the equipment cabinet.

At below ground splice enclosures, coil at least 30 feet of slack cable for each cable entering and exiting the splice enclosure in the manhole or junction box where enclosure is located. Coil and store any drop cable in excess of what is needed for storage in the manhole or junction box in the base of the equipment cabinet.

Mount the drop cable assembly using screws to either the rack frame or rack mount in 19-inch equipment rack in a location convenient to the fiber-optic transceiver. Mount the drop cable assembly close enough to the fiber-optic transceiver to connect them using 3-foot fiber-optic jumpers. Secure drop cable in cabinet using cable ties and wire management hardware.

Install SMFO jumpers between the appropriate connectors on the patch panel of the drop cable assembly and the Ethernet edge switch or the video encoder.

Label all connectors, pigtails, and the connector panel. At the aerial splice enclosure location, cap off all unused fibers and label to correspond with the connector panel.

Where the Plans call for a fiber-optic drop cable to be installed in an existing riser, remove all existing cables from the riser and remove the existing weatherhead, sealing bushing or heat shrink tubing. Install the new fiber-optic drop cable in the existing riser and install new heat shrink tubing at the top of the existing riser using a heat shrink tubing retrofit kit. If the riser contains existing fiber-optic communications cable, carefully remove the fiber-optic cable from the riser so as not violate its minimum bending radius or otherwise damage the cable. Temporarily coil and store the existing fiber-optic cable overhead in a manner approved by the Engineer until the new drop cable can be spliced into the existing cable in an aerial splice enclosure.

Using an OTDR, test the end-to-end connectivity of the drop cable assembly from patch panel installed inside the signal cabinet to the corresponding communications hub. Comply with the OTDR testing and reporting requirements of the "Fiber-Optic Splice Centers" section of the *Standard Specifications* when testing drop cable.

8.4. MEASUREMENT AND PAYMENT

Drop cable assembly (6-fiber) will be measured and paid as the actual number of 6-strand fiber-optic drop cable assemblies of furnished, installed, and accepted.

No measurement will be made for terminating, splicing, and testing fiber-optic cable, communications cable identification markers, SMFO jumpers, as these will be considered incidental to the installation of drop cable assemblies.

Payment will be made under:

Drop Cable Assembly (6-fiber)Each

U-5710A

GT-0.1

New Hanover County

PROJECT SPECIAL PROVISIONS

GEOTECHNICAL

MSE RETAINING WALLS - (1-16-2018)

GT-1.1 - GT-1.12

DocuSigned by:
Geotechnical Engineering Unit
E06538624A11498...

12/4/2019

MECHANICALLY STABILIZED EARTH RETAINING WALLS**(1-16-18)****1.0 GENERAL**

Construct mechanically stabilized earth (MSE) retaining walls consisting of steel or geosynthetic reinforcement in the reinforced zone connected to vertical facing elements. Use precast concrete panels for vertical facing elements and coarse aggregate in the reinforced zone unless noted otherwise in the plans. Provide reinforced concrete coping and pile sleeves as required. Design and construct MSE retaining walls based on actual elevations and wall dimensions in accordance with the contract and accepted submittals. Use a prequalified MSE Wall Installer to construct MSE retaining walls.

Define MSE wall terms as follows:

Geosynthetic or Geogrid Reinforcement – Polyester Type (PET), HDPE or Polypropylene (PP) geogrid reinforcement,

Geogrid – PET, HDPE or PP geogrid,

Reinforcement – Steel or geogrid reinforcement,

Aggregate – Coarse or fine aggregate,

Panel – Precast concrete panel,

Coping – Precast or CIP concrete coping,

MSE Wall – Mechanically stabilized earth retaining wall,

MSE Wall Vendor – Vendor supplying the chosen MSE wall system,

MSE Panel Wall – MSE wall with panels,

MSE Segmental Wall – MSE wall with segmental retaining wall (SRW) units and

Abutment Wall – MSE wall with bridge foundations in any portion of the reinforced zone or an MSE wall connected to an abutment wall (Even if bridge foundations only penetrate a small part of the reinforced zone, the entire MSE wall is considered an abutment wall).

For bridge approach fills behind end bents with MSE abutment walls, design reinforcement connected to end bent caps in accordance with the plans and this provision. Construct Type III Reinforced Bridge Approach Fills in accordance with the *Bridge Approach Fills* provision and Roadway Detail Drawing No. 422D10.

Use an approved MSE wall system in accordance with the plans and any NCDOT restrictions or exceptions for the chosen system. Value engineering proposals for other MSE wall systems will not be considered. Do not use MSE wall systems with an “approved for provisional use” status for abutment walls or MSE walls subject to scour, walls with design heights greater than 35 ft or walls supporting or adjacent to railroads or interstate highways. The list of approved MSE wall systems with approval status is available from:

connect.ncdot.gov/resources/Geological/Pages/Products.aspx

2.0 MATERIALS

Refer to the *Standard Specifications*.

Item
Aggregate

Section
1014

Corrugated Steel Pipe	1032-3
Epoxy, Type 3A	1081
Geosynthetics	1056
Grout, Type 3	1003
Joint Materials	1028
Portland Cement Concrete, Class A	1000
Precast Retaining Wall Coping	1077
Reinforcing Steel	1070
Retaining Wall Panels	1077
Segmental Retaining Wall Units	1040-4
Select Material, Class V	1016
Shoulder Drain Materials	816-2
Steel Pipe	1036-4(A)

Use galvanized corrugated steel pipe with a zinc coating weight of 2 oz/sf (G200) for pile sleeves. Provide Type 2 geotextile for filtration and separation geotextiles. Use Class A concrete for CIP coping, leveling concrete and pads. Use galvanized steel pipe, threaded rods and nuts for the PET geogrid reinforcement vertical obstruction detail. Provide galvanized Grade 36 anchor rods and Grade A hex nuts that meet AASHTO M 314 for threaded rods and nuts.

Use panels and SRW units from producers approved by the Department and licensed by the MSE Wall Vendor. Provide steel strip connectors embedded in panels fabricated from structural steel that meets the requirements for steel strip reinforcement. Unless required otherwise in the contract, produce panels with a smooth flat final finish that meets Article 1077-11 of the *Standard Specifications*. Accurately locate and secure reinforcement connectors in panels and maintain required concrete cover. Produce panels within 1/4" of the panel dimensions shown in the accepted submittals.

Damaged panels or SRW units with excessive discoloration, chips or cracks as determined by the Engineer will be rejected. Do not damage reinforcement connection devices or mechanisms in handling or storing panels and SRW units.

Store steel materials on blocking at least 12" above the ground and protect it at all times from damage; and when placing in the work make sure it is free from dirt, dust, loose mill scale, loose rust, paint, oil or other foreign materials. Handle and store geotextiles and geogrids in accordance with Article 1056-2 of the *Standard Specifications*. Load, transport, unload and store MSE wall materials so materials are kept clean and free of damage. Bent, damaged or defective materials will be rejected.

A. Aggregate

Use standard size No. 57, 57M, 67 or 78M that meets Table 1005-1 of the *Standard Specifications* for coarse aggregate and the following for fine aggregate:

1. Standard size No. 1S, 2S, 2MS or 4S that meets Table 1005-2 of the *Standard Specifications* or

2. Gradation that meets Class III, Type 3 select material in accordance with Article 1016-3 of the *Standard Specifications*.

Fine aggregate is exempt from mortar strength in Subarticle 1014-1(E) of the *Standard Specifications*. Use fine aggregate with a maximum organic content of 1.0%. Provide aggregate with electrochemical properties that meet the following requirements:

AGGREGATE pH REQUIREMENTS		
Aggregate Type (in reinforced zone)	Reinforcement or Connector Material	pH
Coarse or Fine	Steel	5 – 10
Coarse or Fine	PET	5 – 8
Coarse or Fine	Polyolefin (HDPE or Polypropylene)	4.5 – 9

AGGREGATE CHEMICAL REQUIREMENTS (Steel Reinforcement/Connector Materials Only)			
Aggregate Type (in reinforced zone)	Resistivity	Chlorides	Sulfates
Coarse	$\geq 5,000 \Omega \cdot \text{cm}$	$\leq 100 \text{ ppm}$	$\leq 200 \text{ ppm}$
Fine	$\geq 3,000 \Omega \cdot \text{cm}$		

Use aggregate from sources participating in the Department's Aggregate QC/QA Program as described in Section 1006 of the *Standard Specifications*. Sample and test aggregate in accordance with the *Mechanically Stabilized Earth Wall Aggregate Sampling and Testing Procedures*. Electrochemical testing is only required for coarse aggregate from sources in the Coastal Plain as defined by Subarticle 1018-2(B)(1).

B. Reinforcement

Provide steel or geosynthetic reinforcement supplied by the MSE Wall Vendor or a manufacturer approved or licensed by the vendor. Use reinforcement approved for the chosen MSE wall system. The list of approved reinforcement for each MSE wall system is available from the website shown elsewhere in this provision.

1. Steel Reinforcement

Provide Type 1 material certifications in accordance with Article 106-3 of the *Standard Specifications* for steel reinforcement. Use welded wire grid reinforcement ("mesh", "mats" and "ladders") that meet Article 1070-3 of the *Standard Specifications* and steel strip reinforcement ("straps") that meet ASTM A572, A1011 or A463. Use 10 gauge or heavier structural steel Grade 50 or higher for steel strip reinforcement. Galvanize steel reinforcement in accordance with Section 1076 of the *Standard Specifications* or provide aluminized steel strip reinforcement that meet ASTM A463, Type 2-100.

2. Geosynthetic Reinforcement

Use HDPE or PP geogrid for geogrid reinforcement connected to backwalls of end bent caps. Use PET or HDPE geogrid for geogrid reinforcement connected to SRW units and only HDPE geogrid for geogrid reinforcement connected to panels.

Define machine direction (MD) and cross-machine direction (CD) for geogrids per Article 1056-3 of the *Standard Specifications*. Provide Type 1 material certifications and identify geogrid reinforcement in accordance with Article 1056-3 of the *Standard Specifications*.

Provide extruded geogrids manufactured from punched and drawn polypropylene sheets for PP geogrids that meet the following:

PP GEOGRID REQUIREMENTS		
Property	Requirement¹	Test Method
Aperture Dimensions ²	1" x 1.2"	N/A
Minimum Rib Thickness ²	0.07" x 0.07"	N/A
Tensile Strength @ 2% Strain ²	580 lb/ft x 690 lb/ft	ASTM D6637, Method A
Tensile Strength @ 5% Strain ²	1,200 lb/ft x 1,370 lb/ft	
Ultimate Tensile Strength ²	1,850 lb/ft x 2,050 lb/ft	
Junction Efficiency ³ (MD)	93%	ASTM D7737
Flexural Rigidity ⁴	2,000,000 mg-cm	ASTM D7748
Aperture Stability Modulus ⁵	0.55 lb-ft/degrees	ASTM D7864
UV Stability (Retained Strength)	100% (after 500 hr of exposure)	ASTM D4355

1. MARV per Article 1056-3 of the *Standard Specifications* except dimensions and thickness are nominal.
2. Requirement for MD x CD.
3. Junction Efficiency (%) = (Average Junction Strength (X_{jave}) / Ultimate Tensile Strength in the MD from ASTM D6637, Method A) × 100.
4. Test specimens two ribs wide, with transverse ribs cut flush with exterior edges of longitudinal ribs, and sufficiently long to enable measurement of the overhang dimension.
5. Applied moment of 17.7 lb-inch (torque increment).

C. Bearing Pads

For MSE panel walls, use bearing pads that meet Section 3.6.1.a of the *FHWA Design and Construction of Mechanically Stabilized Earth Walls and Reinforced Soil Slopes – Volume I* (Publication No. FHWA-NHI-10-024) except durometer hardness for rubber pads may be 60 or 80 ± 5 and density testing for HDPE pads may be in accordance with ASTM D1505 or D792. Provide bearing pads with thicknesses that meet the following:

BEARING PAD THICKNESS	
Facing Area per Panel (A)	Minimum Pad Thickness After Compression (based on 2 times panel weight above pads)

$A \leq 30$ sf	1/2"
$30 \text{ sf} < A \leq 75$ sf	3/4"

D. Miscellaneous Components

Miscellaneous components may include connectors (e.g., anchors, bars, clamps, pins, plates, ties, etc.), fasteners (e.g., bolts, nuts, washers, etc.) and any other MSE wall components not included above. Galvanize steel components in accordance with Section 1076 of the *Standard Specifications*. Provide miscellaneous components approved for the chosen MSE wall system. The list of approved miscellaneous components for each MSE wall system is available from the website shown elsewhere in this provision.

3.0 PRECONSTRUCTION REQUIREMENTS

A. MSE Wall Surveys

The Retaining Wall Plans show a plan view, typical sections, details, notes and an elevation or profile view (wall envelope) for each MSE wall. Before beginning MSE wall design, survey existing ground elevations shown in the plans and other elevations in the vicinity of MSE wall locations as needed. For proposed slopes above or below MSE walls, survey existing ground elevations to at least 10 ft beyond slope stake points. Based on these elevations, finished grades and actual MSE wall dimensions and details, submit revised wall envelopes for acceptance. Use accepted wall envelopes for design.

B. MSE Wall Designs

For MSE wall designs, submit PDF files of working drawings and design calculations at least 30 days before the preconstruction meeting. Note name and NCDOT ID number of the panel or SRW unit production facility on working drawings. Do not begin MSE wall construction until a design submittal is accepted.

Use a prequalified MSE Segmental Wall Design Consultant to design MSE segmental walls. Provide MSE segmental wall designs sealed by a Design Engineer approved as a Geotechnical Engineer (key person) for the MSE Segmental Wall Design Consultant. Provide MSE panel wall designs sealed by a Design Engineer licensed in the state of North Carolina and employed or contracted by the MSE Wall Vendor.

Design MSE walls in accordance with the plans, *AASHTO LRFD Bridge Design Specifications* and any NCDOT restrictions for the chosen MSE wall system unless otherwise required. Design MSE walls for seismic if walls are located in seismic zone 2 based on Figure 2-1 of the *Structure Design Manual*. Connect reinforcement to panels or SRW units with methods or devices approved for the chosen system. Use a uniform reinforcement length throughout the wall height of at least 0.7H with H as shown in the plans or 6 ft, whichever is longer, unless noted otherwise in the plans. Extend the reinforced zone at least 6" beyond end of reinforcement. Do not locate

drains, the reinforced zone or leveling pads outside right-of-way or easement limits.

Use the simplified method for determining maximum reinforcement loads and design parameters approved for the chosen MSE wall system or default values in accordance with the AASHTO LRFD specifications. Design steel components including reinforcement and connectors for the design life noted in the plans and aggregate type in the reinforced zone. If an MSE wall system with geogrid reinforcement includes any steel parts for obstructions, bin walls, connections or other components, design steel exposed to aggregate for the design life noted in the plans and aggregate type in the reinforced zone. Use “loss of galvanizing” metal loss rates for nonaggressive backfill in accordance with the AASHTO LRFD specifications for galvanized and aluminized steel and metal loss rates for carbon steel in accordance with the following:

CARBON STEEL CORROSION RATES	
Aggregate Type (in reinforced zone)	Carbon Steel Loss Rate (after coating depletion)
Coarse	0.47 mil/year
Fine (except abutment walls)	0.58 mil/year
Fine (abutment walls)	0.70 mil/year

For PET or HDPE geogrid reinforcement and geosynthetic connectors, use approved geosynthetic properties for the design life noted in the plans and aggregate type in the reinforced zone. For geogrid reinforcement connected to end bent caps, embed geosynthetic reinforcement or connectors in caps as shown in the plans. For PP geogrid reinforcement connected to end bent caps, use the following design parameters for the aggregate type in the reinforced approach fill.

PP GEOGRID REINFORCEMENT DESIGN PARAMETERS				
Aggregate Type (in reinforced zone)	T_{al} (MD)	F*	α	ρ
Coarse	400 lb/ft	0.70	0.8	32.0°
Fine	428 lb/ft	0.54	0.8	28.35°

Where,

- T_{al} = long-term design strength (LTDS),
 F* = pullout resistance factor,
 α = scale effect correction factor and
 ρ = soil-geogrid friction angle.

When noted in the plans, design MSE walls for a live load (traffic) surcharge of 250 psf in accordance with Figure C11.5.6-3(b) of the AASHTO LRFD specifications. For steel beam guardrail with 8 ft posts or concrete barrier rail above MSE walls, analyze top 2 reinforcement layers for traffic impact loads in accordance with Section 7.2 of the FHWA MSE wall manual shown elsewhere in this provision except use the following for geosynthetic reinforcement rupture:

$$\phi T_{al} R_c \geq T_{max} + (T_I / RF_{CR})$$

Where,

- ϕ = resistance factor for tensile resistance in accordance with Section 7.2.1 of the FHWA MSE wall manual,
- T_{al} = long-term geosynthetic design strength approved for chosen MSE wall system,
- R_c = reinforcement coverage ratio = 1 for continuous geosynthetic reinforcement,
- T_{max} = factored static load in accordance with Section 7.2 of the FHWA MSE wall manual,
- T_i = factored impact load in accordance with Section 7.2 of the FHWA MSE wall manual and
- RF_{CR} = creep reduction factor approved for chosen MSE wall system.

When shown in the plans for abutment walls, use pile sleeves to segregate piles from aggregate in the reinforced zone. If existing or future obstructions such as foundations, guardrail, fence or handrail posts, moment slabs, pavements, pipes, inlets or utilities will interfere with reinforcement, maintain a clearance of at least 3" between obstructions and reinforcement unless otherwise approved. Design reinforcement for obstructions and locate reinforcement layers so all of reinforcement length is within 3" of corresponding connection elevations. Modify PET geogrid reinforcement for obstructions as shown in the plans.

Use 6" thick CIP unreinforced concrete leveling pads beneath panels and SRW units that are continuous at steps and extend at least 6" in front of and behind bottom row of panels or SRW units. Unless required otherwise in the plans, embed top of leveling pads in accordance with the following requirements:

EMBEDMENT REQUIREMENTS		
Front Slope¹ (H:V)	Minimum Embedment Depth² (whichever is greater)	
6:1 or flatter (except abutment walls)	H/20	1 ft for $H \leq 10$ ft 2 ft for $H > 10$ ft
6:1 or flatter (abutment walls)	H/10	2 ft
> 6:1 to < 3:1	H/10	2 ft
3:1 to 2:1	H/7	2 ft

1. Front slope is as shown in the plans.
2. Define "H" as the maximum design height plus embedment per wall with the design height and embedment as shown in the plans.

When noted in the plans, locate a continuous aggregate shoulder drain along the base of the reinforced zone behind the aggregate. Provide wall drainage systems consisting of drains and outlet components in accordance with Roadway Standard Drawing No. 816.02.

For MSE panel walls, cover joints at back of panels with filtration geotextiles at least 12" wide. If the approval of the chosen MSE wall system does not require a minimum

number of bearing pads, provide the number of pads in accordance with the following:

NUMBER OF BEARING PADS		
Facing Area per Panel (A)	Maximum Wall Height Above Horizontal Panel Joint	Minimum Number of Pads per Horizontal Panel Joint
A ≤ 30 sf	25 ft	2
	35 ft ¹	3
30 sf < A ≤ 75 sf	25 ft	3
	35 ft ¹	4

1. Additional bearing pads per horizontal panel joint may be required for wall heights above joints greater than 35 ft.

For MSE segmental walls, coarse aggregate is required in any SRW unit core spaces and between and behind SRW units for a horizontal distance of at least 18". Separation geotextiles are required between the aggregate and overlying fill or pavement sections except when concrete pavement, full depth asphalt or cement treated base is placed directly on aggregate. When noted in the plans, separation geotextiles are also required at the back of the reinforced zone between the aggregate and backfill or natural ground. Unless required otherwise in the plans, use reinforced concrete coping at top of walls that meets the following requirements:

1. Coping dimensions as shown in the plans,
2. At the Contractor's option, coping that is precast or CIP concrete for MSE panel walls unless CIP coping is required as shown in the plans,
3. CIP concrete coping for MSE segmental walls and
4. At the Contractor's option and when shown in the plans, CIP concrete coping that extends down back of panels or SRW units or connects to panels or SRW units with dowels.

For MSE segmental walls with dowels, attach dowels to top courses of SRW units in accordance with the following:

1. Set dowels in core spaces of SRW units filled with grout instead of coarse aggregate or
2. Embed adhesively anchored dowels in holes of solid SRW units with epoxy.

For MSE panel walls with coping, connect CIP concrete coping or leveling concrete for precast concrete coping to top row of panels with dowels cast into panels. When concrete barrier rail is required above MSE walls, use concrete barrier rail with moment slab as shown in the plans.

Submit working drawings and design calculations for acceptance in accordance with Article 105-2 of the *Standard Specifications*. Submit working drawings showing plan views, wall profiles with foundation pressures, typical sections with reinforcement and

connection details, aggregate locations and types, geotextile locations and details of leveling pads, panels or SRW units, coping, bin walls, slip joints, pile sleeves, etc. If necessary, include details on working drawings for concrete barrier rail with moment slab, reinforcement splices if allowed for the chosen MSE wall system, reinforcement connected to end bent caps, curved MSE walls with tight (short) radii and obstructions extending through walls or interfering with reinforcement, leveling pads, barriers or moment slabs. Submit design calculations for each wall section with different surcharge loads, geometry or material parameters. At least one analysis is required for each wall section with different reinforcement lengths. When designing MSE walls with computer software other than MSEW, use MSEW, version 3.0 with update 14.96 or later, manufactured by ADAMA Engineering, Inc. to verify the design. At least one MSEW analysis is required per 100 ft of wall length with at least one analysis for the wall section with the longest reinforcement. Submit electronic MSEW input files and PDF output files with design calculations.

C. Preconstruction Meeting

Before starting MSE wall construction, hold a preconstruction meeting to discuss the construction and inspection of the MSE walls. If this meeting occurs before all MSE wall submittals have been accepted, additional preconstruction meetings may be required before beginning construction of MSE walls without accepted submittals. The Resident or Bridge Maintenance Engineer, Area Construction Engineer, Geotechnical Operations Engineer, Contractor and MSE Wall Installer Superintendent will attend preconstruction meetings.

4.0 CORROSION MONITORING

Corrosion monitoring is required for MSE walls with steel reinforcement. The Engineer will determine the number of monitoring locations and where to install the instrumentation. Contact M&T before beginning wall construction. M&T will provide the corrosion monitoring instrumentation kits and if necessary, assistance with installation.

5.0 SITE ASSISTANCE

Unless otherwise approved, an MSE Wall Vendor representative is required to assist and guide the MSE Wall Installer on-site for at least 8 hours when the first panels or SRW units and reinforcement layer are placed. If problems are encountered during construction, the Engineer may require the vendor representative to return to the site for a time period determined by the Engineer.

6.0 CONSTRUCTION METHODS

Control drainage during construction in the vicinity of MSE walls. Direct run off away from MSE walls, aggregate and backfill. Contain and maintain aggregate and backfill and protect material from erosion.

Excavate as necessary for MSE walls in accordance with the accepted submittals. If applicable and at the Contractor's option, use temporary shoring for wall construction

instead of temporary slopes to construct MSE walls. Define “temporary shoring for wall construction” as temporary shoring not shown in the plans or required by the Engineer including shoring for OSHA reasons or the Contractor’s convenience.

Unless required otherwise in the plans, install foundations and if required, pile sleeves located in the reinforced zone before placing aggregate or reinforcement. Brace piles in the reinforced zone to maintain alignment when placing and compacting aggregate. Secure piles together with steel members near top of piles. Clamp members to piles instead of welding if bracing is at or below pile cut-off elevations.

Notify the Engineer when foundation excavation is complete. Do not place leveling pad concrete, aggregate or reinforcement until excavation dimensions and foundation material are approved.

Construct CIP concrete leveling pads at elevations and with dimensions shown in the accepted submittals and in accordance with Section 420 of the *Standard Specifications*. Cure leveling pads at least 24 hours before placing panels or SRW units.

Erect and support panels and stack SRW units so the final wall position is as shown in the accepted submittals. Stagger SRW units to create a running bond by centering SRW units over joints in the row below as shown in the accepted submittals. Space bearing pads in horizontal panel joints as shown in the accepted submittals and cover all panel joints with filtration geotextiles as shown in the accepted submittals. Attach filtration geotextiles to back of panels with adhesives, tapes or other approved methods.

Construct MSE walls with the following tolerances:

- A. SRW units are level from front to back and between units when checked with a 4 ft long level,
- B. Vertical joint widths are 1/4" maximum for SRW units and 3/4", $\pm 1/4$ " for panels,
- C. Final wall face is within 3/4" of horizontal and vertical alignment shown in the accepted submittals when measured along a 10 ft straightedge and
- D. Final wall plumbness (batter) is not negative (wall face leaning forward) and within 0.5° of vertical unless otherwise approved.

Place reinforcement at locations and elevations shown in the accepted submittals and within 3" of corresponding connection elevations. Install reinforcement with the direction shown in the accepted submittals. Before placing aggregate, pull geogrid reinforcement taut so it is in tension and free of kinks, folds, wrinkles or creases. Reinforcement may be spliced once per reinforcement length if shown in the accepted submittals. Use reinforcement pieces at least 6 ft long. Contact the Engineer when unanticipated existing or future obstructions such as foundations, guardrail, fence or handrail posts, pavements, pipes, inlets or utilities will interfere with reinforcement. To avoid obstructions, deflect, skew or modify reinforcement as shown in the accepted submittals.

Place aggregate in the reinforced zone in 8" to 10" thick lifts. Compact fine aggregate in accordance with Subarticle 235-3(C) of the *Standard Specifications*. Use only hand

operated compaction equipment to compact aggregate within 3 ft of panels or SRW units. At a distance greater than 3 ft, compact aggregate with at least 4 passes of an 8 ton to 10 ton vibratory roller in a direction parallel to the wall face. Smooth wheeled or rubber tired rollers are also acceptable for compacting aggregate. Do not use sheepsfoot, grid rollers or other types of compaction equipment with feet. Do not displace or damage reinforcement when placing and compacting aggregate. End dumping directly on geogrids is not permitted. Do not operate heavy equipment on reinforcement until it is covered with at least 8" of aggregate. Replace any damaged reinforcement to the satisfaction of the Engineer.

Backfill for MSE walls outside the reinforced zone in accordance with Article 410-8 of the *Standard Specifications*. If a drain is required, install wall drainage systems as shown in the accepted submittals and in accordance with Section 816 of the *Standard Specifications*. If pile sleeves are required, fill sleeves with loose uncompacted sand before constructing end bent caps.

Install dowels as necessary for SRW units and place and construct coping and leveling concrete as shown in the accepted submittals. Construct leveling concrete in accordance with Section 420 of the *Standard Specifications*. Construct CIP concrete coping in accordance with Subarticle 452-4(B) of the *Standard Specifications*. When single faced precast concrete barrier is required in front of and against MSE walls, stop coping just above barrier so coping does not interfere with placing barrier up against wall faces. If the gap between a single faced barrier and wall face is wider than 2", fill gap with Class V select material (standard size No. 78M stone). Otherwise, fill gap with backer rod and seal joint between barrier and MSE wall with silicone sealant.

When separation geotextiles are required, overlap adjacent geotextiles at least 18" and hold geotextiles in place with wire staples or anchor pins as needed. Seal joints above and behind MSE walls between coping and concrete slope protection with silicone sealant.

7.0 MEASUREMENT AND PAYMENT

MSE Retaining Wall No. ___ will be measured and paid in square feet. MSE walls will be measured as the square feet of wall face area with the pay height equal to the difference between top of wall and top of leveling pad elevations. Define "top of wall" as top of coping or top of panels or SRW units for MSE walls without coping.

The contract unit price for *MSE Retaining Wall No. ___* will be full compensation for providing designs, submittals, labor, tools, equipment and MSE wall materials, excavating, backfilling, hauling and removing excavated materials and supplying site assistance, leveling pads, panels, SRW units, reinforcement, aggregate, wall drainage systems, geotextiles, bearing pads, coping, miscellaneous components and any incidentals necessary to construct MSE walls. The contract unit price for *MSE Retaining Wall No. ___* will also be full compensation for reinforcement and connector design for reinforcement connected to end bent caps, wall modifications for obstructions, pile sleeves filled with sand, joints sealed with silicone sealant and gaps between barriers and MSE walls filled with backer rod or No. 78M stone, if required.

No separate payment will be made for temporary shoring for wall construction. Temporary shoring for wall construction will be incidental to the contract unit price for *MSE Retaining Wall No. __*.

The contract unit price for *MSE Retaining Wall No. __* does not include the cost for ditches, fences, handrails, barrier or guardrail associated with MSE walls as these items will be paid for elsewhere in the contract. The contract unit price for *MSE Retaining Wall No. __* also does not include the cost for constructing bridge approach fills behind end bents with MSE abutment walls. See *Bridge Approach Fills* provision for measurement and payment of Type III Reinforced Bridge Approach Fills.

Where it is necessary to provide backfill material behind the reinforced zone from sources other than excavated areas or borrow sources used in connection with other work in the contract, payment for furnishing and hauling such backfill material will be paid as extra work in accordance with Article 104-7 of the *Standard Specifications*. Placing and compacting such backfill material is not considered extra work but is incidental to the work being performed.

Payment will be made under:

Pay Item

MSE Retaining Wall No. __

Pay Unit

Square Foot



DocuSigned by:
Scott A. Hidden
F760CAEB96FC4D3...
12/3/2019

UbO-1

PROJECT SPECIAL PROVISIONS (PSP) Utilities by Others (UbO)



General:

The following utility company have facilities that will be in conflict with the construction of this project:

- A) Power (Distribution) - Duke
- B) Gas (Distribution) – PNG
- C) Communications – AT&T
- D) Communications – CenturyLink
- E) Communications – Segra
- F) Communications - Spectrum

The conflicting facilities of these concerns will be adjusted prior to the date of availability, unless otherwise noted and are therefore listed in these special provisions for the benefit of the Contractor. All utility work listed herein will be done by the utility owners. All utilities are shown on the plans from the best available information.

The Contractor’s attention is directed to Article 105-8 of the 2018 Standard Specifications.

Utilities Requiring Adjustment:

Utility relocations are shown on the Utilities by Others Plans.

- A) Duke Energy (Distribution) – Power
 1. Duke will place new poles and aerial facilities on Eastwood Rd. in the area of the new Drysdale Dr. Ext. intersection and also on Military Cutoff Rd. in the area of the new Drysdale Dr. Ext. intersection. This work will not begin until after the LET date and all clearing and grubbing for the project has been completed by the roadway construction contractor. Duke requires **60 days** notification prior to beginning work with an estimated time to complete of **60 days** from their start date.

Contact for Duke Energy: Mr. Josiah Shackleton at 919 817-5015
jshackleton@duke-energy.com

UbO-2

PROJECT SPECIAL PROVISIONS (PSP) Utilities by Others (UbO)

B) Piedmont Natural Gas - Gas

1. PNG will relocate their facilities after LET and all clearing and grubbing for the project has been completed by the roadway construction contractor. PNG requires **60 days** notification prior to beginning work with an estimated time to complete of **60-75 days** from their start date.

Contact for PNG: Mr. Michael Corrigan at 980 772-8705

mcorrigan@maserconsulting.com

Mr. Kevin Thomas 704 282-8479 kevin.thomas@duke-energy.com

C) AT&T - Communications

1. AT&T will adjust their two existing fiber lines to pass through the proposed drainage conflict box (0410) at the intersection of Eastwood Rd. and Drysdale Dr. Ext. AT&T requires **2 weeks'** notice by the contractor to begin work and shall coordinate with the Contractor to complete this work.

Contact for AT&T: Mr. Austin Godwin at 980 772-8705 austingodwin@telics.com

D) CenturyLink - Communications

1. CenturyLink will relocate their underground facilities after LET and all clearing and grubbing for the project has been completed by the roadway construction contractor. CenturyLink requires **60 days** notification prior to beginning work with an estimated time to complete of **90 days** from their start date.
2. CenturyLink will relocate their aerial facilities on Military Cutoff Rd. after Duke completes their work and gives authorization. CenturyLink requires **20 days** notification prior to beginning work with an estimated time to complete of **10 days** from their start date.

Contact for CenturyLink: Mr. Brett Boger at 336 692-6477 brettboger@telics.com

Mr. Brian Walker 919 710-8893 brian2.walker@centuryLink.com

E) Segra - Communications

1. Segra will relocate their facilities after LET and all clearing and grubbing for the project has been completed by the roadway construction contractor. Segra requires **30 days** notification prior to beginning work with an estimated time to complete of **45-60 days** from their start date.

Contacts for Segra: Mr. Brett Boger at 336 692-6477 brettboger@telics.com

Mr. Mike Wornom 919 710-8893 michael.wornom@segra.com

UbO-3

PROJECT SPECIAL PROVISIONS (PSP)

Utilities by Others (UbO)

F) Spectrum - Communications

1. Spectrum will relocate their facilities after LET and all clearing and grubbing for the project has been completed by the roadway construction contractor. Spectrum requires **30 days** notification prior to beginning work with an estimated time to complete of **90 days** from their start date.
2. Spectrum will adjust their coaxial cable lines as needed to avoid the proposed 24" RCP drainage at the intersection of Eastwood Rd. and Drysdale Dr. Ext. Spectrum requires **2 weeks'** notice by the contractor to begin work and shall coordinate with the Contractor to complete this work.

Contact for Spectrum: Mr. Steve Barnette at 910 772-5755 steve.barnette@charter.com

LISTING OF DBE SUBCONTRACTORS

Sheet of

Firm Name and Address	Item No.	Item Description	* Agreed upon Unit Price	** Dollar Volume of Item
Name Address				
Name Address				
Name Address				
Name Address				
Name Address				
Name Address				

* The Dollar Volume shown in this column shall be the Actual Price Agreed Upon by the Prime Contractor and the DBE subcontractor, and these prices will be used to determine the percentage of the DBE participation in the contract.

** Dollar Volume of DBE Subcontractor Percentage of Total Contract Bid Price:

If firm is a Material Supplier Only, show Dollar Volume as 60% of Agreed Upon Amount from Letter of Intent.

If firm is a Manufacturer, show Dollar Volume as 100% of Agreed Upon Amount from Letter of Intent.

LISTING OF DBE SUBCONTRACTORS

Sheet of

Firm Name and Address	Item No.	Item Description	* Agreed upon Unit Price	** Dollar Volume of Item
Name Address				
Name Address				
Name Address				
Name Address				
Name Address				

**** Dollar Volume of DBE Subcontractor \$ _____**

Percentage of Total Contract Bid Price _____%

*** The Dollar Volume shown in this column shall be the Actual Price Agreed Upon by the Prime Contractor and the DBE subcontractor, and these prices will be used to determine the percentage of the DBE participation in the contract.**

**** Dollar Volume of DBE Subcontractor Percentage of Total Contract Bid Price:
 If firm is a Material Supplier Only, show Dollar Volume as 60% of Agreed Upon Amount from Letter of Intent.
 If firm is a Manufacturer, show Dollar Volume as 100% of Agreed Upon Amount from Letter of Intent.**

**STATE OF NORTH CAROLINA
DEPARTMENT OF TRANSPORTATION
RALEIGH, NC**

CONTRACT PAYMENT BOND

Date of Payment Bond Execution _____

Name of Principal Contractor _____

Name of Surety: _____

Name of Contracting Body: _____

Amount of Bond: _____

Contract ID No.: DC00277

County Name: NEW HANOVER COUNTY

KNOW ALL MEN BY THESE PRESENTS, That we, the PRINCIPAL CONTRACTOR (hereafter, PRINCIPAL) and SURETY above named, are held and firmly bound unto the above named Contracting Body, hereinafter called the Contracting Body, in the penal sum of the amount stated above for the payment of which sum well and truly to be made, we bind ourselves, our heirs, executors, administrators, and successors, jointly and severally, firmly by these presents.

THE CONDITION OF THIS OBLIGATION IS SUCH, that whereas the principal entered into a certain contract with the Contracting Body, numbered as shown above and hereto attached:

NOW THEREFORE, if the principal shall promptly make payment to all persons supplying labor and material in the prosecution of the work provided for in said contract, and any and all duly authorized modifications of said contract that may hereafter be made, notice of which modifications to the surety being hereby waived, then this obligation to be void; otherwise to remain in full force and virtue.

IN WITNESS WHEREOF, the above-bound parties have executed this instrument under their several seals on the date indicated above, the name and corporate seal of each corporate party being hereto affixed and these presents duly signed by its undersigned representative, pursuant to authority of its governing body.

CONTRACT PAYMENT BOND

Affix Seal of Surety Company

Print or type Surety Company Name

By _____
Print, stamp or type name of Attorney-in-Fact

Signature of Attorney-in-Fact

Signature of Witness

Print or type Signer's name

Address of Attorney-in-Fact

CONTRACT PAYMENT BOND

CORPORATION

SIGNATURE OF CONTRACTOR (Principal)

Full name of Corporation

Address as prequalified

By

Signature of President, Vice President, Assistant Vice President
Select appropriate title

Print or type Signer's name

Affix Corporate Seal

Attest

Signature of Secretary, Assistant Secretary
Select appropriate title

Print or type Signer's name

CONTRACT PAYMENT BOND
LIMITED LIABILITY COMPANY

SIGNATURE OF CONTRACTOR (Principal)

Name of Contractor

Full name of Firm

Address as prequalified

By:

Signature of Member, Manager, Authorized Agent
Select appropriate title

Print or type Signer's name

CONTRACT PAYMENT BOND

INDIVIDUAL DOING BUSINESS UNDER A FIRM NAME

SIGNATURE OF CONTRACTOR (Principal)

Name of Contractor

Individual Name

Trading and doing business as

Full name of Firm

Address as prequalified

Signature of Contractor

Individually

Print or type Signer's name

Signature of Witness

Print or type Signer's name

CONTRACT PAYMENT BOND

INDIVIDUAL DOING BUSINESS IN HIS OWN NAME

SIGNATURE OF CONTRACTOR (Principal)

Name of Contractor

Print or type Individual name

Address as prequalified

Signature of Contractor

Individually

Print or type Signer's name

Signature of Witness

Print or type Signer's name

CONTRACT PAYMENT BOND

PARTNERSHIP

SIGNATURE OF CONTRACTOR (Principal)

Full name of Partnership

Address as prequalified

By

Signature of Partner

Print or type Signer's name

Signature of Witness

Print or type Signer's name

CONTRACT PAYMENT BOND
JOINT VENTURE (2) or (3)
SIGNATURE OF CONTRACTORS (Principal)

Instructions to Bidders: 2 Joint Ventures, Fill in lines (1), (2) and (3) and execute. 3 Joint Venturers Fill in lines (1), (2), (3), (4) and execute. On Line (1), print or type the name of Joint Venture. On line (2), print or type the name of one of the joint venturers and execute below in the appropriate manner required by Article 102-8 of the *NC DOT Standard Specifications*. On Line (3), print or type the name of second joint venturer and execute below in the appropriate manner required by said article of the Specifications. On Line (4), print or type the name of the third joint venturer, if applicable and execute below in the appropriate manner required by said article of the Specifications. This form of execution must be strictly followed.

	By	
Signature of Witness or Attest		Signature of Contractor
Print or type Signer's name		Print or type Signer's name

and

	By	
Signature of Witness or Attest		Signature of Contractor
Print or type Signer's name		Print or type Signer's name

and

	By	
Signature of Witness or Attest		Signature of Contractor
Print or type Signer's name		Print or type Signer's name

CONTRACT PAYMENT BOND

Attach certified copy of Power of Attorney to this sheet

**STATE OF NORTH CAROLINA
DEPARTMENT OF TRANSPORTATION
RALEIGH, NC**

CONTRACT PERFORMANCE BOND

Date of Performance Bond Execution: _____

Name of Principal Contractor: _____

Name of Surety: _____

Name of Contracting Body: _____

Amount of Bond: _____

Contract ID No.: DC00277

County Name: NEW HANOVER COUNTY

KNOW ALL MEN BY THESE PRESENTS, That we, the PRINCIPAL CONTRACTOR (hereafter, PRINCIPAL) and SURETY above named, are held and firmly bound unto the above named Contracting Body, hereinafter called the Contracting Body, in the penal sum of the amount stated above for the payment of which sum well and truly to be made, we bind ourselves, our heirs, executors, administrators, and successors, jointly and severally, firmly by these presents.

THE CONDITION OF THIS OBLIGATION IS SUCH, that whereas the principal entered into a certain contract with the Contracting Body, numbered as shown above and hereto attached:

NOW THEREFORE, if the principal shall well and truly perform and fulfill all the undertakings, covenants, terms, conditions, and agreements of said contract during the original term of said contract and any extensions thereof that may be granted by the Contracting Body, with or without notice to the Surety, and during the life of any guaranty required under the contract, and shall also well and truly perform and fulfill all the undertakings, covenants, terms, conditions, and agreements of any and all duly authorized modifications of said contract that may hereafter be made, notice of which modifications to the surety being hereby waived, then this obligation to be void; otherwise to remain in full force and virtue.

IN WITNESS WHEREOF, the above-bound parties have executed this instrument under their several seals on the date indicated above, the name and corporate seal of each corporate party being hereto affixed and these presents duly signed by its undersigned representative, pursuant to authority of its governing body.

CONTRACT PERFORMANCE BOND

Affix Seal of Surety Company

Print or type Surety Company Name

By _____
Print, stamp or type name of Attorney-in-Fact

Signature of Attorney-in-Fact

Signature of Witness

Print or type Signer's name

Address of Attorney-in-Fact

CONTRACT PERFORMANCE BOND

CORPORATION

SIGNATURE OF CONTRACTOR (Principal)

Full name of Corporation

Address as prequalified

By

Signature of President, Vice President, Assistant Vice President
Select appropriate title

Print or type Signer's name

Affix Corporate Seal

Attest

Signature of Secretary, Assistant Secretary
Select appropriate title

Print or type Signer's name

CONTRACT PERFORMANCE BOND

LIMITED LIABILITY COMPANY

SIGNATURE OF CONTRACTOR (Principal)

Name of Contractor

Full name of Firm

Address as prequalified

By:

Signature of Member, Manager, Authorized Agent
Select appropriate title

Print or type Signer's name

CONTRACT PERFORMANCE BOND

INDIVIDUAL DOING BUSINESS UNDER A FIRM NAME

SIGNATURE OF CONTRACTOR (Principal)

Name of Contractor

Individual Name

Trading and doing business as

Full name of Firm

Address as prequalified

Signature of Contractor

Individually

Print or type Signer's name

Signature of Witness

Print or type Signer's name

CONTRACT PERFORMANCE BOND

INDIVIDUAL DOING BUSINESS IN HIS OWN NAME

SIGNATURE OF CONTRACTOR (Principal)

Name of Contractor

 Print or type Individual name

 Address as prequalified

Signature of Contractor

 Individually

 Print or type Signer's name

 Signature of Witness

 Print or type Signer's name

CONTRACT PERFORMANCE BOND

PARTNERSHIP

SIGNATURE OF CONTRACTOR (Principal)

Full name of Partnership

Address as prequalified

By

Signature of Partner

Print or type Signer's name

Signature of Witness

Print or type Signer's name

**CONTRACT PERFORMANCE BOND
JOINT VENTURE (2) OR (3)
SIGNATURE OF CONTRACTORS (Principal)**

Instructions to Bidders: 2 Joint Ventures, Fill in lines (1), (2) and (3) and execute. 3 Joint Venturers Fill in lines (1), (2), (3), (4) and execute. On Line (1), print or type the name of Joint Venture. On line (2), print or type the name of one of the joint venturers and execute below in the appropriate manner required by Article 102-8 of the *NCDOT Standard Specifications*. On Line (3), print or type the name of second joint venturer and execute below in the appropriate manner required by said article of the Specifications. On Line (4), print or type the name of the third joint venturer, if applicable and execute below in the appropriate manner required by said article of the Specifications. This form of execution must be strictly followed.

Signature of Witness or Attest

By

Signature of Contractor

Print or type Signer's name

Print or type Signer's name

and

Signature of Witness or Attest

By

Signature of Contractor

Print or type Signer's name

Print or type Signer's name

and

Signature of Witness or Attest

By

Signature of Contractor

Print or type Signer's name

Print or type Signer's name

CONTRACT PERFORMANCE BOND

Attach certified copy of Power of Attorney to this sheet

**STATE OF NORTH CAROLINA
DEPARTMENT OF TRANSPORTATION
RALEIGH, NC**

BID BOND

Contract Number: DC00277 County: NEW HANOVER COUNTY

KNOW ALL MEN BY THESE PRESENTS, That we, the PRINCIPAL CONTRACTOR (hereafter, PRINCIPAL) and SURETY above named, are held and firmly bound unto the Department of Transportation in the full and just sum of five (5) percent of the total amount bid by the Principal for the project stated above, for the payment of which sum well and truly to be made, we bind ourselves, our heirs, executors, administrators, and successors, jointly and severally, firmly by these presents.

NOW, THEREFORE, the condition of this obligation is: the Principal shall not withdraw its bid within sixty (60) days after the opening of the bids, or within such other time period as may be provided in the proposal, and if the Board of Transportation shall award a contract to the Principal, the Principal shall, within fourteen (14) calendar days after written notice of award is received by him, provide bonds with good and sufficient surety, as required for the faithful performance of the contract and for the protection of all persons supplying labor, material, and equipment for the prosecution of the work. In the event the Principal requests permission to withdraw his bid due to mistake in accordance with the provisions of Article 103-3 of the *Standard Specifications for Roads and Structures*, the conditions and obligations of this Bid Bond shall remain in full force and effect until the Department of Transportation makes a final determination to either allow the bid to be withdrawn or to proceed with award of the contract. In the event a determination is made to award the contract, the Principal shall have fourteen (14) calendar days to comply with the requirements set forth above. In the event the Principal withdraws its bid after bids are opened except as provided in Article 103-3, or after award of the contract has been made fails to execute such additional documents as may be required and to provide the required bonds within the time period specified above, then the amount of the bid bond shall be immediately paid to the Department of Transportation as liquidated damages.

IN TESTIMONY WHEREOF, the Principal and Surety have caused these presents to be duly signed and sealed.

This the _____ day of _____, 20 _____

Surety

By _____
General Agent or Attorney-in-Fact Signature

Seal of Surety

Print or type Signer's Name

BID BOND
CORPORATION

SIGNATURE OF CONTRACTOR (Principal)

Full name of Corporation

Address as prequalified

By _____
Signature of **President, Vice President, Assistant Vice President**
Select appropriate title

Print or type Signer's name

Affix Corporate Seal

Attest _____
Signature of **Secretary, Assistant Secretary**
Select appropriate title

Print or type Signer's name

BID BOND

LIMITED LIABILITY COMPANY

SIGNATURE OF CONTRACTOR (Principal)

Name of Contractor

Full name of Firm

Address as prequalified

**Signature of Member/
Manager/Authorized Agent**

Individually

Print or type Signer's name

BID BOND

INDIVIDUAL DOING BUSINESS UNDER A FIRM NAME

SIGNATURE OF CONTRACTOR (Principal)

Name of Contractor

_____ Individual Name

Trading and doing business as

_____ Full name of Firm

_____ Address as prequalified

Signature of Contractor

_____ Individually

_____ Print or type Signer's name

_____ Signature of Witness

_____ Print or type Signer's name

BID BOND

INDIVIDUAL DOING BUSINESS IN HIS OWN NAME

SIGNATURE OF CONTRACTOR (Principal)

Name of Contractor

Print or type Individual Name

Address as prequalified

Signature of Contractor

Individually

Print or type Signer's name

Signature of Witness

Print or type Signer's name

BID BOND

PARTNERSHIP

SIGNATURE OF CONTRACTOR (Principal)

Full name of Partnership

Address as prequalified

By

Signature of Partner

Print or type Signer's name

Signature of Witness

Print or type Signer's name

BID BOND
JOINT VENTURE (2 or 3)
SIGNATURE OF CONTRACTORS (Principal)

Instructions to Bidders: **2 Joint Ventures**, Fill in lines (1), (2) and (3) and execute. **3 Joint Venturers** Fill in lines (1), (2), (3), (4) and execute. Line (1), print or type the name of Joint Venture. On line (2), print or type the name of one of the joint venturers and execute below in the appropriate manner required by Article 102-8 of the *Specifications*. On Line (3), print or type the name of second joint venturer and execute below in the appropriate manner required by said article of the *Specifications*. On Line (4), print or type the name of the third joint venturer, if applicable and execute below in the appropriate manner required by said article of the *Specifications*. This form of execution must be strictly followed.

_____ Signature of Witness or Attest	By	_____ Signature of Contractor
_____ Print or type Signer's name		_____ Print or type Signer's name

and

_____ Signature of Witness or Attest	By	_____ Signature of Contractor
_____ Print or type Signer's name		_____ Print or type Signer's name

and

_____ Signature of Witness or Attest	By	_____ Signature of Contractor
_____ Print or type Signer's name		_____ Print or type Signer's name

ADDENDUM(S)

ADDENDUM #1

I, _____
(SIGNATURE)

representing _____

Acknowledge receipt of Addendum #1.

ADDENDUM #2

I, _____
(SIGNATURE)

representing _____

Acknowledge receipt of Addendum #2.

ADDENDUM #3

I, _____
(SIGNATURE)

representing _____

Acknowledge receipt of Addendum #3.

AWARD LIMITS ON MULTIPLE PROJECTS

It is the desire of the Proposer to be awarded contracts, the value of which will not exceed a total of \$ _____, for those projects indicated below on which bids are being opened on the same date as shown in the Proposal Form. Individual projects shall be indicated by placing the project number and county in the appropriate place below. Projects not selected will not be subject to an award limit.

(Project Number)

(County)

(Project Number)

(County)

(Project Number)

(County)

(Project Number)

(County)

*If a Proposer desires to limit the total amount of work awarded to him in this letting, he shall state such limit in the space provided above in the second line of this form.

It is agreed that in the event that I am (we are) the successful bidder on indicated projects, the total value of which is more than the above stipulated award limits, the Board of Transportation will award me (us) projects from among those indicated which have a total value not exceeding the award limit and which will result in the best advantage to the Department of Transportation.

**Signature of Authorized Person

**Only those persons authorized to sign bids under the provisions of Article 102-8, Item 7, shall be authorized to sign this form.

EXECUTION OF BID

NON-COLLUSION, DEBARMENT AND GIFT BAN CERTIFICATION

CORPORATION

The prequalified bidder being duly sworn, solemnly swears (or affirms) that neither he, nor any official, agent or employee has entered into any agreement, participated in any collusion, or otherwise taken any action which is in restraint of free competitive bidding in connection with any bid or contract, that the prequalified bidder has not been convicted of violating *N.C.G.S. §133-24* within the last three years, and that the prequalified bidder intends to do the work with his own bona fide employees or subcontractors and will not bid for the benefit of another contractor.

By submitting this non-collusion, debarment and gift ban certification, the Contractor is attesting his status under penalty of perjury under the laws of the United States in accordance with the Debarment Certification attached, provided that the Debarment Certification also includes any required statements concerning exceptions that are applicable.

N.C.G.S. §133-32 and Executive Order 24 prohibit the offer to, or acceptance by, any State Employee of any gift from anyone with a contract with the State, or from any person seeking to do business with the State. By execution of any response in this procurement, you attest, for your entire organization and its employees or agents, that you are not aware that any such gift has been offered, accepted, or promised by any employees of your organization.

SIGNATURE OF PREQUALIFIED BIDDER

Full name of Corporation

Address as Prequalified

Attest _____
Secretary/Assistant Secretary
(Select appropriate title)

By _____
President/Vice President/Assistant Vice President
(Select appropriate title)

Print or type Signer's name

Print or type Signer's name

CORPORATE SEAL

**NON-COLLUSION AFFIDAVIT, DEBARMENT CERTIFICATION AND GIFT BAN CERTIFICATION
PARTNERSHIP**

The prequalified bidder, being duly sworn, solemnly swears (or affirms) that neither he, nor any official, agent or employee has entered into any agreement, participated in any collusion, or otherwise taken any action which is in restraint of free competitive bidding in connection with any bid or contract, that the prequalified bidder has not been convicted of violating *N.C.G.S. § 133-24* within the last three years, and that the prequalified bidder intends to do the work with its own bona fide employees or subcontractors and will not bid for the benefit of another contractor.

By submitting this non-collusion, debarment and gift ban certification, the Contractor is attesting his status under penalty of perjury under the laws of the United States in accordance with the Debarment Certification attached, provided that the Debarment Certification also includes any required statements concerning exceptions that are applicable.

N.C.G.S. § 133-32 and Executive Order 24 prohibit the offer to, or acceptance by, any State Employee of any gift from anyone with a contract with the State, or from any person seeking to do business with the State. By execution of any response in this procurement, you attest, for your entire organization and its employees or agents, that you are not aware that any such gift has been offered, accepted, or promised by any employees of your organization.

SIGNATURE OF PREQUALIFIED BIDDER

Full Name of
Partnership

Address as
Prequalified

Signature of Witness

Signature of Partner

Print or Type Signer's Name

Print or Type Signer's Name

**NON-COLLUSION AFFIDAVIT, DEBARMENT CERTIFICATION AND GIFT BAN
CERTIFICATION**

LIMITED LIABILITY COMPANY

The prequalified bidder, being duly sworn, solemnly swears (or affirms) that neither he, nor any official, agent or employee has entered into any agreement, participated in any collusion, or otherwise taken any action which is in restraint of free competitive bidding in connection with any bid or contract, that the prequalified bidder has not been convicted of violating *N.C.G.S. § 133-24* within the last three years, and that the prequalified bidder intends to do the work with its own bona fide employees or subcontractors and will not bid for the benefit of another contractor.

By submitting this non-collusion, debarment and gift ban certification, the Contractor is attesting his status under penalty of perjury under the laws of the United States in accordance with the Debarment Certification attached, provided that the Debarment Certification also includes any required statements concerning exceptions that are applicable.

N.C.G.S. § 133-32 and Executive Order 24 prohibit the offer to, or acceptance by, any State Employee of any gift from anyone with a contract with the State, or from any person seeking to do business with the State. By execution of any response in this procurement, you attest, for your entire organization and its employees or agents, that you are not aware that any such gift has been offered, accepted, or promised by any employees of your organization.

SIGNATURE OF PREQUALIFIED BIDDER

Full Name of Firm

Address as Prequalified

Signature of Witness

Signature of Member/Manager/Authorized Agent
(Select appropriate Title)

Print or Type Signer's Name

Print or Type Signer's Name

NON-COLLUSION, DEBARMENT AND GIFT BAN CERTIFICATION

JOINT VENTURE (2) or (3)

The prequalified bidder, being duly sworn, solemnly swears (or affirms) that neither he, nor any official, agent or employee has entered into any agreement, participated in any collusion, or otherwise taken any action which is in restraint of free competitive bidding in connection with any bid or contract, that the prequalified bidder has not been convicted of violating *N.C.G.S. § 133-24* within the last three years, and that the prequalified bidder intends to do the work with its own bona fide employees or subcontractors and will not bid for the benefit of another contractor.

By submitting this non-collusion, debarment and gift ban certification, the Contractor is attesting his status under penalty of perjury under the laws of the United States in accordance with the Debarment Certification attached, provided that the Debarment Certification also includes any required statements concerning exceptions that are applicable.

N.C.G.S. § 133-32 and Executive Order 24 prohibit the offer to, or acceptance by, any State Employee of any gift from anyone with a contract with the State, or from any person seeking to do business with the State. By execution of any response in this procurement, you attest, for your entire organization and its employees or agents, that you are not aware that any such gift has been offered, accepted, or promised by any employees of your organization.

SIGNATURE OF PREQUALIFIED BIDDER

Instructions: **2 Joint Venturers** Fill in lines (1), (2) and (3) and execute. **3 Joint Venturers** Fill in lines (1), (2), (3) and (4) and execute. On Line (1), fill in the name of the Joint Venture Company. On Line (2), fill in the name of one of the joint venturers and execute below in the appropriate manner. On Line (3), print or type the name of the other joint venturer and execute below in the appropriate manner. On Line (4), fill in the name of the third joint venturer, if applicable and execute below in the appropriate manner.

(1) _____
Name of Joint Venture

(2) _____
Name of Contractor

Address as Prequalified

Signature of Witness or Attest

 BY _____
Signature of Contractor

Print or Type Signer's Name

Print or Type Signer's Name

If Corporation, affix Corporate Seal AND

(3) _____
Name of Contractor

Address as Prequalified

Signature of Witness or Attest

 BY _____
Signature of Contractor

Print or Type Signer's Name

Print or Type Signer's Name

If Corporation, affix Corporate Seal AND

(4) _____
Name of Contractor

Address as Prequalified

Signature of Witness or Attest

 BY _____
Signature of Contractor

Print or Type Signer's Name

Print or Type Signer's Name

If Corporation, affix Corporate Seal

**NON-COLLUSION AFFIDAVIT, DEBARMENT CERTIFICATION AND GIFT BAN
CERTIFICATION**

INDIVIDUAL DOING BUSINESS UNDER A FIRM NAME

The prequalified bidder, being duly sworn, solemnly swears (or affirms) that neither he, nor any official, agent or employee has entered into any agreement, participated in any collusion, or otherwise taken any action which is in restraint of free competitive bidding in connection with any bid or contract, that the prequalified bidder has not been convicted of violating *N.C.G.S. § 133-24* within the last three years, and that the prequalified bidder intends to do the work with its own bona fide employees or subcontractors and will not bid for the benefit of another contractor.

By submitting this non-collusion, debarment and gift ban certification, the Contractor is attesting his status under penalty of perjury under the laws of the United States in accordance with the Debarment Certification attached, provided that the Debarment Certification also includes any required statements concerning exceptions that are applicable.

N.C.G.S. § 133-32 and Executive Order 24 prohibit the offer to, or acceptance by, any State Employee of any gift from anyone with a contract with the State, or from any person seeking to do business with the State. By execution of any response in this procurement, you attest, for your entire organization and its employees or agents, that you are not aware that any such gift has been offered, accepted, or promised by any employees of your organization.

SIGNATURE OF PREQUALIFIED BIDDER

Name of Prequalified Bidder

Individual Name

Trading and Doing Business As

Full name of Firm

Address as Prequalified

Signature of Witness

Signature of Prequalified Bidder, Individual

Print or Type Signer's Name

Print or Type Signer's Name

**NON-COLLUSION AFFIDAVIT, DEBARMENT CERTIFICATION AND GIFT BAN
CERTIFICATION**

INDIVIDUAL DOING BUSINESS IN HIS OWN NAME

The prequalified bidder, being duly sworn, solemnly swears (or affirms) that neither he, nor any official, agent or employee has entered into any agreement, participated in any collusion, or otherwise taken any action which is in restraint of free competitive bidding in connection with any bid or contract, that the prequalified bidder has not been convicted of violating *N.C.G.S. § 133-24* within the last three years, and that the prequalified bidder intends to do the work with its own bona fide employees or subcontractors and will not bid for the benefit of another contractor.

By submitting this non-collusion, debarment and gift ban certification, the Contractor is attesting his status under penalty of perjury under the laws of the United States in accordance with the Debarment Certification attached, provided that the Debarment Certification also includes any required statements concerning exceptions that are applicable.

N.C.G.S. § 133-32 and Executive Order 24 prohibit the offer to, or acceptance by, any State Employee of any gift from anyone with a contract with the State, or from any person seeking to do business with the State. By execution of any response in this procurement, you attest, for your entire organization and its employees or agents, that you are not aware that any such gift has been offered, accepted, or promised by any employees of your organization.

SIGNATURE OF PREQUALIFIED BIDDER

Name of Prequalified Bidder _____
Print or Type Name

Address as Prequalified

Signature of Prequalified Bidder, Individually

Print or type Signer's Name

Signature of Witness

Print or type Signer's name

DEBARMENT CERTIFICATION OF PREQUALIFIED BIDDER

Conditions for certification:

1. The prequalified bidder shall provide immediate written notice to the Department if at any time the bidder learns that his certification was erroneous when he submitted his debarment certification or explanation that is file with the Department, or has become erroneous because of changed circumstances.
2. The terms *covered transaction*, *debarred*, *suspended*, *ineligible*, *lower tier covered transaction*, *participant*, *person*, *primary covered transaction*, *principal*, *proposal*, and *voluntarily excluded*, as used in this provision, have the meanings set out in the Definitions and Coverage sections of the rules implementing Executive Order 12549. A copy of the Federal Rules requiring this certification and detailing the definitions and coverages may be obtained from the Contract Officer of the Department.
3. The prequalified bidder agrees by submitting this form, that he will not knowingly enter into any lower tier covered transaction with a person who is debarred, suspended, declared ineligible, or voluntarily excluded from participation in NCDOT contracts, unless authorized by the Department.
4. For Federal Aid projects, the prequalified bidder further agrees that by submitting this form he will include the Federal-Aid Provision titled *Required Contract Provisions Federal-Aid Construction Contract (Form FHWA PR 1273)* provided by the Department, without subsequent modification, in all lower tier covered transactions.
5. The prequalified bidder may rely upon a certification of a participant in a lower tier covered transaction that he is not debarred, suspended, ineligible, or voluntarily excluded from the covered transaction, unless he knows that the certification is erroneous. The bidder may decide the method and frequency by which he will determine the eligibility of his subcontractors.
6. Nothing contained in the foregoing shall be construed to require establishment of a system of records in order to render in good faith the certification required by this provision. The knowledge and information of a participant is not required to exceed that which is normally possessed by a prudent person in the ordinary course of business dealings.
7. Except as authorized in paragraph 6 herein, the Department may terminate any contract if the bidder knowingly enters into a lower tier covered transaction with a person who is suspended, debarred, ineligible, or voluntarily excluded from participation in this transaction, in addition to other remedies available by the Federal Government.

DEBARMENT CERTIFICATION

The prequalified bidder certifies to the best of his knowledge and belief, that he and his principals:

- a. Are not presently debarred, suspended, proposed for debarment, declared ineligible, or voluntarily excluded from covered transactions by any Federal department or agency;
- b. Have not within a three-year period preceding this proposal been convicted of or had a civil judgment rendered against them for commission of fraud or a criminal offense in connection with obtaining, attempting to obtain, or performing a public (Federal, State or local) transaction or contract under a public transaction; violation of Federal or State antitrust statutes or commission of embezzlement, theft, forgery, bribery, falsification or destruction of records; making false statements; or receiving stolen property;
- c. Are not presently indicted for or otherwise criminally or civilly charged by a governmental entity (Federal, State or local) with commission of any of the offenses enumerated in paragraph b. of this certification; and
- d. Have not within a three-year period preceding this proposal had one or more public transactions (Federal, State or local) terminated for cause or default.
- e. Will submit a revised Debarment Certification immediately if his status changes and will show in his bid proposal an explanation for the change in status.

If the prequalified bidder cannot certify that he is not debarred, he shall provide an explanation with this submittal. An explanation will not necessarily result in denial of participation in a contract.

Failure to submit a non-collusion affidavit and debarment certification will result in the prequalified bidder's bid being considered non-responsive.

Check here if an explanation is attached to this certification.

County : New Hanover

Line #	Item Number	Sec #	Description	Quantity	Unit Cost	Amount
ROADWAY ITEMS						
0001	0000100000-N	800	MOBILIZATION	Lump Sum	L.S.	
0002	0000400000-N	801	CONSTRUCTION SURVEYING	Lump Sum	L.S.	
0003	0001000000-E	200	CLEARING & GRUBBING .. ACRE(S) MODIFIED METHOD III	Lump Sum	L.S.	
0004	0008000000-E	200	SUPPLEMENTARY CLEARING & GRUB- BING	1 ACR		
0005	0022000000-E	225	UNCLASSIFIED EXCAVATION	4,000 CY		
0006	0036000000-E	225	UNDERCUT EXCAVATION	1,100 CY		
0007	0106000000-E	230	BORROW EXCAVATION	6,000 CY		
0008	0134000000-E	240	DRAINAGE DITCH EXCAVATION	510 CY		
0009	0156000000-E	250	REMOVAL OF EXISTING ASPHALT PAVEMENT	250 SY		
0010	0195000000-E	265	SELECT GRANULAR MATERIAL	950 CY		
0011	0196000000-E	270	GEOTEXTILE FOR SOIL STABILIZA- TION	1,300 SY		
0012	0234000000-E	SP	GENERIC GRADING ITEM STORMWATER POND GRADING	910 CY		
0013	0257000000-E	SP	GENERIC GRADING ITEM SHOULDER CLEANUP	950 LF		
0014	0318000000-E	300	FOUNDATION CONDITIONING MATE- RIAL, MINOR STRUCTURES	260 TON		
0015	0320000000-E	300	FOUNDATION CONDITIONING GEO- TEXTILE	820 SY		
0016	0335200000-E	305	15" DRAINAGE PIPE	24 LF		
0017	0448000000-E	310	***** RC PIPE CULVERTS, CLASS IV 60"	376 LF		
0018	0448200000-E	310	15" RC PIPE CULVERTS, CLASS IV	996 LF		

County : New Hanover

Line #	Item Number	Sec #	Description	Quantity	Unit Cost	Amount
0019	0448300000-E	310	18" RC PIPE CULVERTS, CLASS IV	588 LF		
0020	0448400000-E	310	24" RC PIPE CULVERTS, CLASS IV	424 LF		
0021	0448500000-E	310	30" RC PIPE CULVERTS, CLASS IV	28 LF		
0022	0995000000-E	340	PIPE REMOVAL	257 LF		
0023	1011000000-N	500	FINE GRADING	Lump Sum	L.S.	
0024	1099500000-E	505	SHALLOW UNDERCUT	100 CY		
0025	1099700000-E	505	CLASS IV SUBGRADE STABILIZATION	190 TON		
0026	1121000000-E	520	AGGREGATE BASE COURSE	6,600 TON		
0027	1220000000-E	545	INCIDENTAL STONE BASE	100 TON		
0028	1330000000-E	607	INCIDENTAL MILLING	1,260 SY		
0029	1491000000-E	610	ASPHALT CONC BASE COURSE, TYPE B25.0C	110 TON		
0030	1503000000-E	610	ASPHALT CONC INTERMEDIATE COURSE, TYPE I19.0C	3,660 TON		
0031	1519000000-E	610	ASPHALT CONC SURFACE COURSE, TYPE S9.5B	2,800 TON		
0032	1575000000-E	620	ASPHALT BINDER FOR PLANT MIX	370 TON		
0033	2000000000-N	806	RIGHT-OF-WAY MARKERS	35 EA		
0034	2022000000-E	815	SUBDRAIN EXCAVATION	739.2 CY		
0035	2026000000-E	815	GEOTEXTILE FOR SUBSURFACE DRAINS	3,300 SY		
0036	2036000000-E	815	SUBDRAIN COARSE AGGREGATE	554.4 CY		
0037	2044000000-E	815	6" PERFORATED SUBDRAIN PIPE	3,300 LF		
0038	2070000000-N	815	SUBDRAIN PIPE OUTLET	7 EA		

County : New Hanover

Line #	Item Number	Sec #	Description	Quantity	Unit Cost	Amount
0039	2077000000-E	815	6" OUTLET PIPE	42 LF		
0040	2220000000-E	838	REINFORCED ENDWALLS	11.8 CY		
0041	2286000000-N	840	MASONRY DRAINAGE STRUCTURES	37 EA		
0042	2308000000-E	840	MASONRY DRAINAGE STRUCTURES	28.2 LF		
0043	2374000000-N	840	FRAME WITH GRATE & HOOD, STD 840.03, TYPE ** E	6 EA		
0044	2374000000-N	840	FRAME WITH GRATE & HOOD, STD 840.03, TYPE ** F	9 EA		
0045	2374000000-N	840	FRAME WITH GRATE & HOOD, STD 840.03, TYPE ** G	12 EA		
0046	2396000000-N	840	FRAME WITH COVER, STD 840.54	10 EA		
0047	2440000000-N	852	CONCRETE TRANSITIONAL SECTION FOR CATCH BASIN	4 EA		
0048	2473000000-N	SP	GENERIC DRAINAGE ITEM DRAWDOWN STRUCTURE	1 EA		
0049	2542000000-E	846	1'-6" CONCRETE CURB & GUTTER	1,440 LF		
0050	2549000000-E	846	2'-6" CONCRETE CURB & GUTTER	3,320 LF		
0051	2591000000-E	848	4" CONCRETE SIDEWALK	800 SY		
0052	2600000000-N	848	RETROFIT EXISTING CURB RAMPS	1 EA		
0053	2605000000-N	848	CONCRETE CURB RAMPS	13 EA		
0054	2655000000-E	852	5" MONOLITHIC CONCRETE ISLANDS (KEYED IN)	130 SY		
0055	2738000000-E	SP	GENERIC PAVING ITEM OYSTER SHELL 6" CONC. DRIVEWAY	70 SY		
0056	2752000000-E	SP	GENERIC PAVING ITEM OYSTER SHELL SPECIAL VALLEY GU TTER	260 LF		

County : New Hanover

Line #	Item Number	Sec #	Description	Quantity	Unit Cost	Amount
0057	3524000000-E	SP	VINYL COATED CHAIN LINK FENCE, *** FABRIC BLACK VINYL COATED CHAIN LINK FENCE 48" FABRIC	110 LF		
0058	3578000000-N	SP	GENERIC FENCING ITEM BLACK VINYL COATED METAL GATE POSTS FOR 48" CHAIN LINK FENCE, SING LE GATE	2 EA		
0059	3578000000-N	SP	GENERIC FENCING ITEM BLACK VINYL COATED METAL LINE POSTS FOR 48" CHAIN LINK FENCE	5 EA		
0060	3578000000-N	SP	GENERIC FENCING ITEM BLACK VINYL COATED METAL TERMI NAL POSTS FOR 48" CHAIN LINK FENCE	10 EA		
0061	3578000000-N	SP	GENERIC FENCING ITEM BLACK VINYL COATED SINGLE GATE S 48" HIGH, 10' WIDE, 10' OPENIN G	2 EA		
0062	3628000000-E	876	RIP RAP, CLASS I	85 TON		
0063	3649000000-E	876	RIP RAP, CLASS B	10 TON		
0064	3656000000-E	876	GEOTEXTILE FOR DRAINAGE	560 SY		
0065	4025000000-E	901	CONTRACTOR FURNISHED, TYPE *** SIGN E	111 SF		
0066	4025000000-E	901	CONTRACTOR FURNISHED, TYPE *** SIGN F	37 SF		
0067	4072000000-E	903	SUPPORTS, 3-LB STEEL U-CHANNEL	355 LF		
0068	4102000000-N	904	SIGN ERECTION, TYPE E	17 EA		
0069	4108000000-N	904	SIGN ERECTION, TYPE F	4 EA		
0070	4155000000-N	907	DISPOSAL OF SIGN SYSTEM, U- CHANNEL	1 EA		

County : New Hanover

Line #	Item Number	Sec #	Description	Quantity	Unit Cost	Amount
0071	4360000000-N	SP	GENERIC SIGNING ITEM VERTICAL PANEL TYPE 3 OBJECT M ARKER -OM3-L	2 EA		
0072	4400000000-E	1110	WORK ZONE SIGNS (STATIONARY)	120 SF		
0073	4405000000-E	1110	WORK ZONE SIGNS (PORTABLE)	192 SF		
0074	4410000000-E	1110	WORK ZONE SIGNS (BARRICADE MOUNTED)	80 SF		
0075	4415000000-N	1115	FLASHING ARROW BOARD	2 EA		
0076	4420000000-N	1120	PORTABLE CHANGEABLE MESSAGE SIGN	2 EA		
0077	4430000000-N	1130	DRUMS	50 EA		
0078	4435000000-N	1135	CONES	12 EA		
0079	4445000000-E	1145	BARRICADES (TYPE III)	660 LF		
0080	4455000000-N	1150	FLAGGER	6 DAY		
0081	4480000000-N	1165	TMA	2 EA		
0082	4510000000-N	1190	LAW ENFORCEMENT	32 HR		
0083	4650000000-N	1251	TEMPORARY RAISED PAVEMENT MARKERS	305 EA		
0084	4685000000-E	1205	THERMOPLASTIC PAVEMENT MARKING LINES (4", 90 MILS)	9,017 LF		
0085	4695000000-E	1205	THERMOPLASTIC PAVEMENT MARKING LINES (8", 90 MILS)	4,932 LF		
0086	4700000000-E	1205	THERMOPLASTIC PAVEMENT MARKING LINES (12", 90 MILS)	404 LF		
0087	4720000000-E	1205	THERMOPLASTIC PAVEMENT MARKING CHARACTER (90 MILS)	24 EA		
0088	4725000000-E	1205	THERMOPLASTIC PAVEMENT MARKING SYMBOL (90 MILS)	70 EA		

County : New Hanover

Line #	Item Number	Sec #	Description	Quantity	Unit Cost	Amount
0089	4810000000-E	1205	PAINT PAVEMENT MARKING LINES (4")	17,819 LF		
0090	4820000000-E	1205	PAINT PAVEMENT MARKING LINES (8")	9,912 LF		
0091	4825000000-E	1205	PAINT PAVEMENT MARKING LINES (12")	616 LF		
0092	4835000000-E	1205	PAINT PAVEMENT MARKING LINES (24")	2,694 LF		
0093	4840000000-N	1205	PAINT PAVEMENT MARKING CHARAC- TER	48 EA		
0094	4845000000-N	1205	PAINT PAVEMENT MARKING SYMBOL	140 EA		
0095	4850000000-E	1205	REMOVAL OF PAVEMENT MARKING LINES (4")	2,796 LF		
0096	4860000000-E	1205	REMOVAL OF PAVEMENT MARKING LINES (8")	46 LF		
0097	4865000000-E	1205	REMOVAL OF PAVEMENT MARKING LINES (12")	173 LF		
0098	4875000000-N	1205	REMOVAL OF PAVEMENT MARKING SYMBOLS & CHARACTERS	11 EA		
0099	4890000000-E	SP	GENERIC PAVEMENT MARKING ITEM LONGITUDINAL CHANNELIZING CURB SYSTEM	1,375 LF		
0100	4891000000-E	1205	GENERIC PAVEMENT MARKING ITEM THERMOPLASTIC (24", 90 MILS)	1,340 LF		
0101	4900000000-N	1251	PERMANENT RAISED PAVEMENT MARKERS	276 EA		
0102	6000000000-E	1605	TEMPORARY SILT FENCE	5,290 LF		
0103	6006000000-E	1610	STONE FOR EROSION CONTROL, CLASS A	190 TON		
0104	6009000000-E	1610	STONE FOR EROSION CONTROL, CLASS B	125 TON		
0105	6012000000-E	1610	SEDIMENT CONTROL STONE	330 TON		

County : New Hanover

Line #	Item Number	Sec #	Description	Quantity	Unit Cost	Amount
0106	6015000000-E	1615	TEMPORARY MULCHING	10		ACR
0107	6018000000-E	1620	SEED FOR TEMPORARY SEEDING	600		LB
0108	6021000000-E	1620	FERTILIZER FOR TEMPORARY SEEDING	3		TON
0109	6024000000-E	1622	TEMPORARY SLOPE DRAINS	200		LF
0110	6029000000-E	SP	SAFETY FENCE	840		LF
0111	6030000000-E	1630	SILT EXCAVATION	120		CY
0112	6036000000-E	1631	MATTING FOR EROSION CONTROL	2,600		SY
0113	6037000000-E	SP	COIR FIBER MAT	100		SY
0114	6042000000-E	1632	1/4" HARDWARE CLOTH	760		LF
0115	6046000000-E	1636	TEMPORARY PIPE FOR STREAM CROSSING	25		LF
0116	6070000000-N	1639	SPECIAL STILLING BASINS	2		EA
0117	6071012000-E	SP	COIR FIBER WATTLE	390		LF
0118	6071020000-E	SP	POLYACRYLAMIDE (PAM)	10		LB
0119	6071030000-E	1640	COIR FIBER BAFFLE	20		LF
0120	6084000000-E	1660	SEEDING & MULCHING	10		ACR
0121	6087000000-E	1660	MOWING	6		ACR
0122	6090000000-E	1661	SEED FOR REPAIR SEEDING	100		LB
0123	6093000000-E	1661	FERTILIZER FOR REPAIR SEEDING	0.25		TON
0124	6096000000-E	1662	SEED FOR SUPPLEMENTAL SEEDING	200		LB
0125	6108000000-E	1665	FERTILIZER TOPDRESSING	5.75		TON

County : New Hanover

Line #	Item Number	Sec #	Description	Quantity	Unit Cost	Amount
0126	6111000000-E	SP	IMPERVIOUS DIKE	80	LF	
0127	6114500000-N	1667	SPECIALIZED HAND MOWING	10	MHR	
0128	6117000000-N	SP	RESPONSE FOR EROSION CONTROL	13	EA	
0129	6117500000-N	SP	CONCRETE WASHOUT STRUCTURE	2	EA	
0130	6132000000-N	SP	GENERIC EROSION CONTROL ITEM FABRIC INSERT INLET PROTECTION DEVICE	4	EA	
0131	6132000000-N	SP	GENERIC EROSION CONTROL ITEM FABRIC INSERT INLET PROTECTION DEVICE CLEANOUT	10	EA	
0132	7048500000-E	1705	PEDESTRIAN SIGNAL HEAD (16", 1 SECTION W/COUNTDOWN)	12	EA	
0133	7060000000-E	1705	SIGNAL CABLE	8,280	LF	
0134	7120000000-E	1705	VEHICLE SIGNAL HEAD (12", 3 SECTION)	30	EA	
0135	7132000000-E	1705	VEHICLE SIGNAL HEAD (12", 4 SECTION)	5	EA	
0136	7144000000-E	1705	VEHICLE SIGNAL HEAD (12", 5 SECTION)	1	EA	
0137	7264000000-E	1710	MESSENGER CABLE (3/8")	1,020	LF	
0138	7279000000-E	1715	TRACER WIRE	1,010	LF	
0139	7300000000-E	1715	UNPAVED TRENCHING (*****) 2 CONDUITS, 2 INCH	2,015	LF	
0140	7301000000-E	1715	DIRECTIONAL DRILL (*****) 2 CONDUITS, 2 INCH	775	LF	
0141	7324000000-N	1716	JUNCTION BOX (STANDARD SIZE)	30	EA	
0142	7348000000-N	1716	JUNCTION BOX (OVER-SIZED, HEA- VY DUTY)	10	EA	
0143	7360000000-N	1720	WOOD POLE	2	EA	

County : New Hanover

Line #	Item Number	Sec #	Description	Quantity	Unit Cost	Amount
0144	7372000000-N	1721	GUY ASSEMBLY	4		EA
0145	7420000000-E	1722	2" RISER WITH WEATHERHEAD	2		EA
0146	7444000000-E	1725	INDUCTIVE LOOP SAWCUT	3,380		LF
0147	7456000000-E	1726	LEAD-IN CABLE (*****) 14-2 PAIR	10,290		LF
0148	7516000000-E	1730	COMMUNICATIONS CABLE (**FIBER) 12 FIBER	600		LF
0149	7540000000-N	1731	SPLICE ENCLOSURE	3		EA
0150	7564000000-N	1732	FIBER-OPTIC TRANSCEIVER, DROP & REPEAT	3		EA
0151	7576000000-N	SP	METAL STRAIN SIGNAL POLE	6		EA
0152	7588000000-N	SP	METAL POLE WITH SINGLE MAST ARM	4		EA
0153	7613000000-N	SP	SOIL TEST	10		EA
0154	7614100000-E	SP	DRILLED PIER FOUNDATION	40		CY
0155	7630000000-N	SP	METAL STRAIN POLE DESIGN	6		EA
0156	7631000000-N	SP	MAST ARM WITH METAL POLE DE- SIGN	4		EA
0157	7636000000-N	1745	SIGN FOR SIGNALS	1		EA
0158	7642200000-N	1743	TYPE II PEDESTAL WITH FOUND- ATION	12		EA
0159	7684000000-N	1750	SIGNAL CABINET FOUNDATION	3		EA
0160	7720000000-N	1751	CONTROLLER WITH CABINET (TYPE 170E, BASE MOUNTED)	3		EA
0161	7780000000-N	1751	DETECTOR CARD (TYPE 2070L)	32		EA
0162	7901000000-N	1753	CABINET BASE EXTENDER	3		EA

County : New Hanover

Line #	Item Number	Sec #	Description	Quantity	Unit Cost	Amount
0163	7960000000-N	SP	METAL POLE FOUNDATION REMOVAL	4	EA	
0164	7972000000-N	SP	METAL POLE REMOVAL	4	EA	
0165	7980000000-N	SP	GENERIC SIGNAL ITEM DROP CABLE ASSEMBLY (6 FIBER)	3	EA	
0166	7980000000-N	SP	GENERIC SIGNAL ITEM MICROWAVE VEHICLE DETECTION SY STEM - MULTIPLE ZONES	1	EA	
0167	7980000000-N	SP	GENERIC SIGNAL ITEM PROTECTIVE COATING FOR SIGNAL PEDESTAL (BLACK)	12	EA	
0168	7980000000-N	SP	GENERIC SIGNAL ITEM PROTECTIVE COATING FOR SINGLE MAST ARM POLE (BLACK)	4	EA	
0169	7980000000-N	SP	GENERIC SIGNAL ITEM PROTECTIVE COATING FOR STRAIN POLE (BLACK)	6	EA	
0170	7990000000-E	SP	GENERIC SIGNAL ITEM BACK PULL FIBER OPTIC CABLE	740	LF	
0171	8801000000-E	SP	MSE RETAINING WALL NO **** AVG. HT. 8.71' TO 9.03'	2,530	SF	

1039/Dec12/Q146491.6/D758299162000/E171

Total Amount Of Bid For Entire Project :